

**THIRD INTERNATIONAL CONFERENCE ON PERMAFROST**  
**Edmonton, July 1978**

ENGLISH TRANSLATIONS OF THE FORTY-NINE SOVIET  
PAPERS, THE ONE FRENCH PAPER, AND THE THREE  
INVITED SOVIET THEME PAPERS

PART I: ENGLISH TRANSLATIONS OF TWENTY-SIX  
OF THE SOVIET PAPERS

**TROISIÈME CONFÉRENCE INTERNATIONALE SUR LE PERGÉLISOL**  
**Edmonton, juillet 1978**

VERSIONS ANGLAISES DES QUARANTE-NEUF MÉMOIRES SOVIÉTIQUES,  
DU MÉMOIRE FRANÇAIS, ET DES RÉTROSPECTIVES  
PRÉSENTÉES PAR DES CHERCHEURS SOVIÉTIQUES

PARTIE I: VERSIONS ANGLAISES DE VINGT-SIX  
MÉMOIRES SOVIÉTIQUES

THIRD INTERNATIONAL CONFERENCE ON PERMAFROST

TROISIÈME CONFÉRENCE INTERNATIONALE SUR LE PERGÉLISOL

Edmonton, July/juillet 1978

ENGLISH TRANSLATIONS OF THE FORTY-NINE SOVIET PAPERS,  
THE ONE FRENCH PAPER, AND THE THREE INVITED  
SOVIET THEME PAPERS

VERSIONS ANGLAISES DES QUARANTE-NEUF MÉMOIRES SOVIÉTIQUES,  
DU MÉMOIRE FRANÇAIS, ET DES TROIS RÉTROSPECTIVES  
PRÉSENTÉES PAR DES CHERCHEURS SOVIÉTIQUES

PART I: ENGLISH TRANSLATIONS OF TWENTY-SIX  
OF THE SOVIET PAPERS  
(Published in Vol. 1 of  
Conference Proceedings)

PARTIE I: VERSIONS ANGLAISES DE VINGT-SIX  
MÉMOIRES SOVIÉTIQUES  
(publiées dans le Vol. 1 du  
Compte rendu de la Conférence)

OTTAWA, March/mars 1980

NRCC 18119  
Part I of two  
Partie I de deux

Published by the  
NATIONAL RESEARCH COUNCIL OF CANADA

Copies obtainable from: The Executive Secretary, Third International Conference on  
Permafrost, c/o National Research Council of Canada, Ottawa, Ontario, K1A 0R6.

Price: \$35.00 (Parts I and II)

Part I

ISBN 0-660-10520-9  
NRCC No. 18119  
Cat. No. NR15-6/1978-3-1

Part II

ISBN 0-660-10521-7  
NRCC No. 18119  
Cat. No. NR15-6/1978-3-2

NOTE:

Volumes 1 and 2 of the Conference Proceedings have the following identification:

Vol. 1 ISBN 0-660-01735-0  
NRCC No. 16529  
Cat. No. NR15-6/1978-1

Vol. 2 ISBN 0-660-50401-4  
NRCC No. 16529  
Cat. No. NR15-6/1978-2

Publié par le  
CONSEIL NATIONAL DE RECHERCHES DU CANADA

On peut obtenir des copies en s'adressant au Secrétaire administratif, Troisième  
conférence internationale sur le pergélisol a/s du Conseil national de recherches  
du Canada, Ottawa, Ontario, K1A 0R6.

Prix: \$35.00 (Parties I et II)

Partie I

ISBN 0-660-10520-9  
CNRC N° 18119  
N° de cat. NR15-6/1978-3-1

Partie II

ISBN 0-660-10521-7  
CNRC N° 18119  
N° de cat. NR15-6/1978-3-2

REMARQUE:

Les volumes 1 et 2 du Compte rendu de la Conférence sont identifiés comme suit:

Vol. 1 ISBN 0-660-01735-0  
CNRC N° 16529  
N° de cat. NR15-6/1978-1

Vol. 2 ISBN 0-660-50401-4  
CNRC N° 16529  
N° de cat. NR15-6/1978-2

## PREFACE

The Third International Conference on Permafrost was held in Edmonton, Alberta, in July 1978. It was sponsored by the National Research Council of Canada through its Associate Committee on Geotechnical Research (Chairman - Dr. L.W. Gold, Associate Director, Division of Building Research, National Research Council of Canada). The Proceedings of the Conference, published in two volumes, included 139 submitted papers (Vol. 1) and 8 invited special theme papers (Vol. 2). This present publication (in two Parts) contains the 49 submitted Soviet papers, the 1 submitted French paper, and the 3 Soviet theme papers. The papers are in the same order as they appear in the Conference Proceedings.

This record is dedicated to the memory of Mr. Valery Poppe, a noted Russian interpreter and translator with the National Research Council of Canada. For many years he provided invaluable interpretation and translation services in the permafrost field which greatly assisted contacts between North American and Soviet scientists. He played an active role at the Third International Conference on Permafrost only weeks before his sudden and untimely death in September 1978. The NRC Associate Committee on Geotechnical Research and the Division of Building Research wish to take this opportunity to express their sincere appreciation of Mr. Poppe's many contributions to the work of the Division and the ACGR through the years.

Their thanks are here recorded also to the other translators for their services in the preparation of these books: P.J. Hyde and Associates, Walter Kent, Josef Nowosielski, Hazel Pidcock, Victor Popov, Robert Serré, Donald Sinclair, and Tania Thorpe. The technical editing was done by R.J.E. Brown, Division of Building Research with assistance from T.W.H. Baker of the same Division. Dr. Brown was Chairman of the Conference. The work of Lise Esselmont, NRC Translations, in organizing all the translations and producing the final typewritten manuscripts is also gratefully acknowledged.

Ottawa  
March 1980

C.B. Crawford  
Director, DBR/NRC

## PRÉFACE

La Troisième conférence internationale sur le pergélisol a été tenue à Edmonton, Alberta, au mois de juillet, 1978. Elle a été parrainée par le Conseil national de recherches du Canada par l'entremise de son Comité associé de recherches géotechniques (Président - Dr. L.W. Gold, directeur adjoint, Division des recherches sur le bâtiment, Conseil national de recherches du Canada). Le compte rendu de la Conférence, publié en deux volumes, comprend 139 mémoires (vol. 1) et 8 rétrospectives spéciales (vol. 2). La présente publication (en deux parties) comporte 49 mémoires soviétiques, le mémoire français et les trois rétrospectives soviétiques. Les mémoires apparaissent dans le même ordre que celui du compte rendu de la Conférence.

Ce document est dédié à la mémoire de M. Valery Poppe, interprète et traducteur russe distingué qui a travaillé au sein du Conseil national de recherches du Canada. Pendant plusieurs années, il a fourni un service d'interprétation et de traduction inestimable dans le domaine du pergélisol, qui a grandement aidé les rapports entre les scientifiques nord-américains et soviétiques. Il joua un rôle actif lors de la Troisième conférence internationale sur le pergélisol quelques semaines seulement avant sa mort soudaine et prématurée survenue au mois de septembre, 1978. Le Comité associé de recherches géotechniques du CNR et la Division des recherches sur le bâtiment profite de l'occasion pour exprimer leur gratitude pour les nombreuses contributions de M. Poppe au travail de la Division et du CARG au cours des années.

Il remercie également les autres traducteurs pour leurs services lors de la préparation de ces livres: P.J. Hyde et associés, Walter Kent, Josef Nowosielski, Hazel Pidcock, Victor Popov, Robert Serré, Donald Sinclair, et Tania Thorpe. La révision technique a été faite par R.J.E. Brown, de la Division des recherches sur le bâtiment avec l'aide de T.W.H. Baker de la même Division. Le Dr. Brown était le président de la Conférence. Le travail de Lise Esselmont, des Services de traduction du CNR, pour l'organisation de toutes les traductions et la production du document final est aussi grandement apprécié.

Ottawa  
mars 1980

C.B. Crawford  
Directeur, DRB/CNR

TABLE OF CONTENTS  
(Parts I and II)

PART I

	Page
Balobaev, V.T. Reconstruction of Palaeoclimate from Present Day Geothermal Data .....	1 ✓
Gavrilova, M.K. Classification of the Relationship Between Climate and Permafrost-Climatic Regions .....	13 ✓
Moskalenko, N.G. et al. The Effect of Developing a Territory on the Heat Balance and the Thermal and Moisture Regime of the Ground in the Northern Part of Western Siberia .....	29 ✓
Pavlov, A.V. Thermal Physics of Permafrost Terrain .....	45 ✓
Kudryavtsev, V.A. and Melamed, V.G. Geophysical Aspects of the Development of Permafrost .....	63 ✓
Kvlividze, V.I. et al. An NMR Study of the Phase Transition of Water in Models and in Frozen Clays .....	81 ✓
Savel'ev, B.A. Investigation of the Structure and Properties of Bound Water .....	97 ✓
Shvetsov, P.F. Conditions and Geothermal Consequences of the Moisture Exchange Between the Lithosphere and the Atmosphere in Permafrost Regions .....	109 ✓
Zhestkova, T.N. Results of Experimental Studies of the Freezing Process in Very Fine-Grained Soils .....	119 ✓
Chizhov, A.B. The Role of Highly Mineralized Groundwater in the Cooling of the Lithosphere at Depth .....	137 ✓
Ershov, E.D. et al. Experimental Investigation of Heat and Moisture Transfer During Sublimation - Desublimation of Water in Fine-Grained Soils .....	143 ✓
Ershov, E.D. et al. Water Migration, Formation of Texture and Ice Segregation in Freezing and Thawing Clayey Soils .....	159 ✓
Fotiev, S.M. Effect of Long-Term Cryometamorphism of Earth Materials on the Formation of Groundwater .....	177 ✓
Romanovskii, N.N. et al. Long Term Dynamics of Groundwater Icings .....	195 ✓
Baulin, V.V. et al. The Role of Tectonics in the Formation of Permafrost on Low Plains .....	209 ✓

	Page
Gasanov, Sh.Sh. Cryolithogenesis as an Independent Hydrothermal Type of Sedimentary Process .....	225 ✓
Gravis, G.F. Cyclic Nature of Thermokarst on the Maritime Plain in the Upper Pleistocene and Holocene .....	245 ✓
Grechishchev, S.E. Some Aspects of the Mechanics of Frost Fracturing of Soils in the Permafrost Zone .....	259 ✓
Konishchev, V.N. Mineral Stability in the Zone of Cryolithogenesis .....	279 ✓
Romanovskii, N.N. Principles of Classification of Polygonal-Vein Structures .....	297 ✓
Are, F.E. Offshore Permafrost in the Asiatic Arctic .....	311 ✓
Baranov, I. Ya. Structure of the Northern Circumpolar Permafrost Region .....	327 ✓
Dubikov, G.I. More Precise Position of the Southern Permafrost Boundary Between the Urals and the Ob River .....	347 ✓
Gorbunov, A.P. Permafrost in the Mountains of Central Asia .....	357 ✓
Kudryavtsev, V.A. et al. Zonal and Regional Patterns of Formation of the Permafrost Region in the U.S.S.R. ....	371 ✓
Popov, A.I. et al. Cryolithological Map of the U.S.S.R. (Principles of Compilation) .....	391 ✓

## PART II

Vtyurin, B.I. Principles of Cryolithological Regionalization of the Permafrost Zone .....	1
Grave, N.A. and Sukhodrovskii, V.L. Terrain-Forming Processes in the Permafrost Region and the Principles of Their Prevention and Limitation in Territories under Development .....	11
Anisimova, N.P. Hydrogeochemical Investigations in Permafrost Studies .....	25
Avetikyan, Yu. A. Use of AC Current Surveys in Permafrost Studies .....	43

	Page
Kudryavtsev, V.A. and Maksimova, L.N. Forecast of Changes in Geocryological Conditions during Economic Development of the Permafrost Region .....	57
Kudryavtsev, V.A. and Kondrat'eva, K.A. Geocryological Survey Methods .....	71
Mel'nikov, V.I. and Gennadinik, B.I. Electrical State of a Permafrost Cross Section .....	85
Garagulya, L.S. et al. Thermal Interaction of Pipelines with the Ground .....	103
Aguirre-Puente, J. Present State of Research on the Freezing of Rocks and Construction Materials .....	117
Dokuchaev, V.V. et al. Ice Rich Soils as Bases for Structures .....	133
Frolov, A.D. Problems and Possibilities of Studying the Processes of Dynamic Relaxation in Frozen Earth Materials .....	149
Maksimyak, R.V. et al. On the Role of the Components of Frozen Clay Soils in the Development of Strength at Different Temperatures .....	169
Vyalov, S.S. Kinetic Theory of Deformation of Frozen Soils .....	185
Baulin, V.V. et al. Permafrost Investigations in Pipeline Construction .....	199
Biyarov, G.F. and Makarov, V.I. Characteristics of the Construction of Frozen Dams in Western Yakutiya .....	213
Buchko, N.A. et al. Seasonally Operating Units and Their Use in Northern Construction .....	227
Makarov, V.I. et al. Construction of Multi-Storey Buildings on Cold Piles in the City of Mirnyi .....	241
Peretrukhin, N.A. Strength and Stability of Railway Subgrades in Permafrost Regions .....	255
Popov, B.I. et al. Construction of Earth Embankments for Highways in Western Siberia .....	269
Porkhaev, G.V. et al. Construction by the Method of Stabilizing Perennially Frozen Foundation Soils .....	283
Vyalov, S.S. Long-Term Settlement of Foundations on Permafrost .....	297
Maksimov, V.M. Hydrodynamic and Hydrochemical Assessment of Explosions Used in Testing Low-Output Wells in Permafrost Regions .....	313



	Page
El'chaninov, E.A. et al. The Stability of Underground Workings in Permafrost .....	321
Emel'yanov, V.I. and Perl'shtein, G.Z. Water Thawing of Frozen Ground for Open Pit and Underground Mining in the Northeast of the U.S.S.R. ....	339
Mel'nikov, P.I. Permafrost - Hydrogeological Zoning of Eastern Siberia .....	355
Vyalov, S.S. Interaction between Permafrost and Buildings .....	379
Tsytovich, N.A. et al. Design, Construction and Operation of Earth Dams in Arctic Regions and under Permafrost Conditions .....	407

## RECONSTRUCTION OF PALAEOCLIMATE FROM PRESENT DAY GEOTHERMAL DATA

V.T. Balobaev

Permafrost Institute, Yakutsk

Earth materials are a medium in which thermodynamic disequilibrium processes at a given moment of time depend not only on parameters of the state of these materials and the gradients of these parameters at that moment of time, but also on the state of the materials during earlier stages, i.e., their prehistory. Thus one might say that such a medium has a memory.

The memory has the property of attenuation, which is defined as weakening of the memory concerning much earlier stages of the process. The evolution of the state of materials in time is described by the Liouville equation (Dei, 1974), from which it follows that not only are the details of the initial state forgotten with time, but they are described with a steadily decreasing set of parameters. For different media and different processes, the time scales of attenuation vary over a wide range.

We shall examine only the thermal state of earth materials, which depends on temperature and heat fluxes (or temperature gradients). Earth materials are media with low thermal conductivity. Hence, heat transfer in them takes place slowly in both time and space. The space factor is extremely important as far as the attenuation of memory is concerned. A thick mass of earth materials contains a vast amount of information on thermal prehistory and thermal states in former times. Attempts to extract this information by analyzing the thermal state of the ground outside of the permafrost region have not been successful. The effect of the former epochs on the present day temperature field of earth materials lies within the accuracy of interpretation, and the latter is difficult because of our

inadequate knowledge of the properties of the medium, various side effects and small amplitudes of temperature fluctuations in former times. In spite of the low thermal conductivity, the relaxation of temperature changes occurs fairly rapidly.

The situation is different, if heat transfer in earth materials is accompanied by phase changes, i.e., by freezing of water or melting of ice. Indeed, it follows from the equation of thermal conductivity that the dimensionless time of temperature stabilization in the frozen zone is described by the Fourier criterion  $F_0 = ar/\xi^2$ , where  $a$  is the thermal conductivity of earth materials,  $r$  is the time, and  $\xi$  is the thickness of permafrost. At the same time, it follows from the condition of energy conservation at the phase boundary (the Stefan condition), that the time of stabilization of this boundary depends on the complex criterion  $\lambda Tr/\xi^2 Q$ , where  $\lambda$  is the thermal conductivity of earth materials,  $T$  is the temperature and  $Q$  is the heat released or absorbed during the phase transition. This criterion can be represented in a different way:  $(ar/\xi^2) \times (\lambda T/aQ)$ , where the first term represents the same Fourier criterion.

The second term is always less than unity. It is close to unity for dense sedimentary and crystalline materials and is 10 to 50 times less for weakly cemented materials containing water. This means that in the first case the rate of heat transfer and the rate of movement of the phase boundary are about the same. In the second case, however, the heat transfer is much faster than the movement of the phase boundary. Here the temperature field is almost completely dependent on the phase processes. In moist, freezing-thawing materials, the memory attenuates very slowly. Their present day thermal state carries much information on the former temperature conditions over a long period of time.

A change in the temperature field of the ground generally starts at the surface, since the most dynamic factor of temperature formation is the climate which changes considerably. Warm epochs are followed by cold periods of glaciation.

If we could extract information on the former thermal state of frozen, weakly cemented earth materials, we could form an opinion on the

climates in the past. The more recent this past, the more complete and accurate the information. It is now possible to extract this type of data from contemporary disequilibrium permafrost which occurs over large areas in the northern part of the U.S.S.R.

The analysis of its thermal state shows very clearly that our time is warmer than the most recent epoch. It is possible to single out three types of temperature fields of disequilibrium permafrost (see Figure 1). The first type refers to low temperature, homogeneous, disequilibrium permafrost characteristic of Central Yakutia and the extreme northern part of Tyumen' Oblast'. The second type is characteristic of practically non-gradient, homogeneous, disequilibrium permafrost, whose temperature is the same as the melting point of pore and fissure ice. This type is widely present in the northern parts of Tyumen' Oblast' and some parts of Yakutia adjacent to the middle and lower reaches of the Vilyui River.

Figure 1

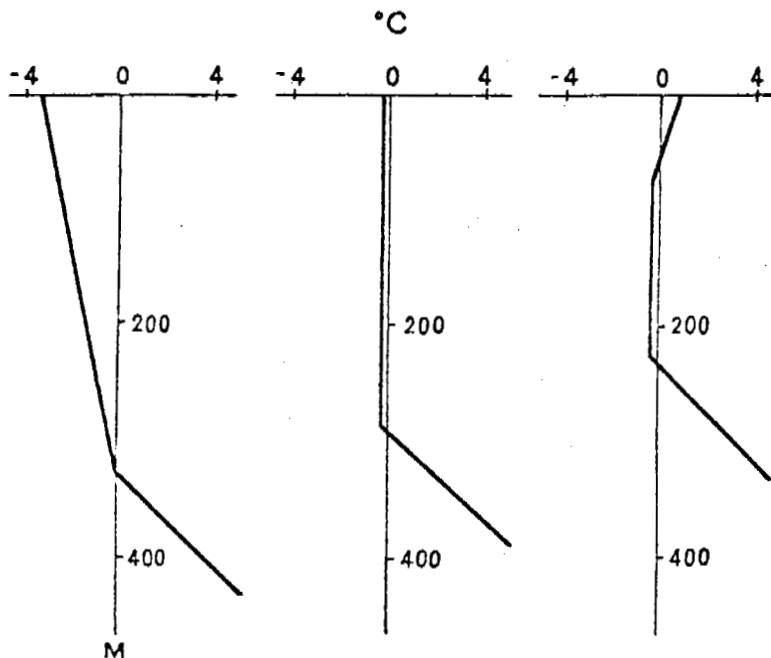

Types of temperature fields in disequilibrium permafrost.

The third type is found in relic permafrost which does not extend to the surface and thaws from above. The main characteristic of all types of disequilibrium permafrost is the fact that at present it thaws from below because the flow of heat towards the lower phase boundary in unfrozen soils

exceeds the outflow of heat from this boundary in frozen ground, i.e.,  
 $q_t > q_m$ .

Recent geothermal investigations, in which special attention was paid to the thermal state of earth materials at the phase boundary, indicate quite clearly that the climate in Western and Eastern Siberia, as well as in Yakutia is getting warmer. The pronounced warming trend is indicated by a considerable discrepancy between the thermal state of permafrost and the temperature conditions on the surface. The climate has been getting warmer slowly and over a long period of time, since the temperature field in permafrost and in the underlying unfrozen material is quasi-stationary within the experimental error, i.e., it has sufficient time to become stabilized. The warming trend was not complicated by prolonged cold spells of considerable amplitude, since the thermal process now observed in earth materials has been proceeding in one direction only. This does not exclude the possibility of short-period temperature fluctuations lasting less than 500 - 1000 years, which cannot have any effect on the lower phase boundary. The warming trend occurred over the entire northern part of the U.S.S.R. and was probably of global extent, since similar disequilibrium permafrost formations are found in the entire permafrost zone in sedimentary rocks of post-Jurassic age. Such are the qualitative deductions which follow from the analysis of available geothermal data. These data were also subjected to quantitative treatment but this proved to be very difficult. As a first step, it was required to solve the problem of permafrost thawing from below due to the intraterrestrial heat flux and the temperature changes on the surface. An approximate solution was given by us earlier on the assumption that the temperature field in the unfrozen zone was quasi-stationary (Balobaev, 1971; 1973). As an initial condition, we assumed that in the middle of the last climatic minimum, the thickness of the frozen zone corresponded to the ground temperature at the surface, while the temperature field of earth materials was stationary. In other words,  $T_0 \lambda_m / \epsilon_0 = -q_t$ ,  $q_t > 0$ , where  $T_0$  is the temperature of the ground surface during the climatic minimum,  $\lambda_m$  is the thermal conductivity of permafrost, and  $\epsilon_0$  is the thickness of the frozen zone during the same period. Such a moment invariably occurs if a cooling trend is followed by a warming trend. It does not coincide exactly with the middle of the cold period but is slightly displaced depending on the temperature.

As a boundary condition, we took a linear increase in the surface temperature beginning with the end of the cold period, when the temperature field became stationary and up to the present time:  $T_{\Pi} = T_0 + \beta r$ , where  $T_{\Pi}$  is the temperature of the ground surface,  $r$  is the time and  $\beta$  is the average rate of temperature change. The actual temperature increase in the thousands of years since the last glacial period was, of course, not linear. But then the problem is so difficult because we do not know what form the temperature increase did take in the past. The linear approximation is the simplest and, in the absence of true information, perhaps the best assumption. Apart from time, it introduces only one other unknown parameter - the rate of change in the surface temperature of the ground. A more complex approximation would have required a much larger number of unknown parameters making a solution of the problem impossible. Even with our simple assumption we could not arrive at a closed system of equations and find a correct solution.

In the given case we obtain:

$$T_0 = T_{\Pi} \sqrt{\frac{\theta^2 + \theta + \gamma}{\theta^2 \gamma}} \exp \left[ \frac{1}{\sqrt{\Delta}} \left( \operatorname{arctg} \frac{1 + 2\theta}{\sqrt{\Delta}} + \operatorname{arctg} \frac{1}{\sqrt{\Delta}} \right) \right],$$

where

$$\begin{aligned} \theta &= \frac{T_{\Pi} \lambda_M}{q_T \xi}; & \gamma &= \frac{Q \lambda_M}{q_T^2} \beta; \\ T_{\Pi} &= T_0 + \beta r; & Q &= 80 \delta W - \frac{1}{3} T_{\Pi} \delta c; \\ \Delta &= 4\gamma - 1 > 0; & q_T &> 0 \end{aligned}$$

$\xi$  is the present thickness of permafrost;  $\delta$  is the unit weight of dry soils, while  $W$  and  $c$  are the water content and the specific heat of earth materials respectively.

In this equation  $T_0$  and  $\beta$  are unknown. If they were known, we could determine  $\xi$  and  $r$ . Thus in any given case we have one equation with two unknowns. An unambiguous solution requires a second equation but we could not derive it for the data available to us. The equation describing the temperature field within frozen or unfrozen ground would be suitable for this. However, as was mentioned earlier, the present temperature field contains no traces of former changes. The phase processes alone provide some

information, since we analyzed geothermal data for very thick permafrost, and the information required extends over tens of thousands of years.

In recent years much has been done in the study of the absolute chronology of climatic changes in the Late Pleistocene and Holocene of Siberia (Kind, 1974). It was determined that the stationary regime of permafrost at the transition from the last cooling trend to the warming trend was evidently established 18,000 - 20,000 years ago.

In this case the suggested equation will depend on only one variable - the surface temperature of earth materials during the last (Sartan) glaciation, which was very close to the minimum temperature.

Use was made of geothermal data from 12 points in the permafrost region of the U.S.S.R. Seven of these were in Yakutia, one in Eastern Siberia and three in Western Siberia. The initial geothermal data are given in Table I. The water content and the heat absorbed during phase transitions were not measured directly but were calculated from other data. It is these parameters that are responsible for the main calculation error. It was established that a change in  $Q$  of 20 - 30% resulted in a temperature difference of 1 - 2°C. It will be shown later that this error is quite acceptable and amounts to 10 - 15%.

During the period covered by the calculations, thawing from below was taking place in the Cretaceous and Jurassic sandstones of Yakutia, the Cretaceous sands and clays in the area around Turukhansk, and in the Palaeogene clays in the northern part of Western Siberia. This is the reason for considerable differences in the calculation parameters (Table I).

Even a brief examination of the data helps to establish that abnormally thick contemporary permafrost could have been formed only at surface temperatures of -8°C to -10°C in Yakutia, -6°C in Eastern Siberia and -7°C to -9°C in Western Siberia.

The calculated surface temperatures of permafrost, its thickness and the average rates of temperature changes 20,000 years ago are shown in Table II. At that time permafrost was 7°C to 14°C colder than now and its

temperature reached  $-14^{\circ}\text{C}$ . There were no significant temperature differences between points in Yakutia and, for example, Western Siberia. The cooling trend evidently extended over the entire permafrost region but was less severe in the Lena Valley (Namtsy, Yakutsk, Promyshlennyi). We should note that even now the temperatures there are slightly higher than in the adjacent areas. The average rate of increase in the temperature was  $0.5^{\circ}\text{C}$  per 1000 years. It was higher in Western Siberia and lower in Yakutia. We should remember, however, that the points in Western Siberia are  $2^{\circ}\text{C}$  -  $3^{\circ}\text{C}$  farther north (approximately at the Arctic Circle) than the points in Yakutia. During the Sartan glaciation, the thickness of permafrost in Yakutia reached 800 m. As is the case at present, it varied within a wide range from place to place, depending on the geological conditions. In the course of 20,000 years, earth materials with a high water content thawed not more than 100 - 150 m, while denser and less porous materials thawed 250 - 300 m. The average rate of thaw ranged from 0.6 to 1.5 cm per year. At present it is 1.5 - 2.5 cm per year. This means that in the initial stage of thaw the phase processes were proceeding at a slower rate than now. If the present conditions will remain largely unchanged, approximately the same length of time will elapse before the thickness of permafrost is stabilized.

We also calculated the palaeotemperatures of permafrost 15,000 years ago. They followed the same patterns, but for obvious reasons were slightly higher (by not more than  $1^{\circ}\text{C}$  for most points). This indicates that it is possible to analyze the palaeoclimate, even if the estimated time of the climatic minimum contains a significant error.

The palaeotemperatures are a function of the air temperature, which is the main characteristic of the climate. Hence they are also a function of the palaeoclimate. To determine the exact difference between the temperature of the ground surface and that of the air, it is essential to know such parameters as radiation and the thermal components of the exchange between the surface and the atmosphere, the dynamic characteristics of the atmosphere, and precipitation (especially in winter) at the time of the climatic minimum. It is hardly possible to obtain these data, hence a simpler approach is required. We shall assume that the differences between the air temperature and the temperature of the ground surface has remained unchanged. In actual fact, this difference was probably smaller in the past than it is now.



Table I

Initial geothermal parameters for the calculations of palaeotemperatures

Point	Latitude	Longitude	$T_{\text{II}},$ °C	$\epsilon,$ M	$\lambda_t,$ kcal/hr. M. °C	$\lambda_M,$ kcal/hr. M. °C	$\delta,$ kg/m <sup>3</sup>	W, %	Q, kcal/hr.m <sup>3</sup>	$q_t,$ kcal/m.m <sup>2</sup>	$q_M,$ kcal/m.m <sup>2</sup>
Bakhynai	66	123	-5.0	650	2.2	2.6	2350	12	20000	0.046	0.018
Vilyuisk	64	122	-3.0	600	2.3	2.6	2400	9	15800	0.046	0.011
Nantsy	63	130	-3.2	480	2.0	2.7	2200	16	24300	0.047	0.014
Kyzyl-Syr	64	124	-1.3	460	2.3	2.6	2250	13	22200	0.055	0.007
Nedzheli	64	126	0.0	450	2.4	2.7	2300	12	19700	0.050	0.0
Yakutsk	62	130	-2.0	350	2.7	2.8	2550	4	7800	0.043	0.016
Sobo-Khaya	64	127	-1.4	80	2.6	2.7	2350	9	15800	0.090	0.047
Promyshlennyi	64	126	-2.8	150	2.7	2.8	2350	9	16000	0.080	0.050
Turukhansk	66	85	0.0	270	1.7	2.2	2100	20	28000	0.048	0.0
Medvezh'e	66	74	+1.0	280	1.4	1.6	2000	21	27600	0.050	0.0
Yubileinoe	66	76	0.0	240	1.4	1.6	2000	21	27500	0.046	0.0
Urengoi	66	77	0.0	360	1.4	1.7	2000	21	27500	0.043	0.0

Table II

Results of palaeogeothermal calculations for a period 20,000 years ago.

Point	$T_0$ , °C	$T_{\Pi} - T_0$ , °C	$\beta$ , °C/1000 years	$\xi_0$ , M	$\xi_0 - \xi$ , M
Bakhynai	-14.1	9.1	0.45	800	150
Vilyuisk	-13.7	10.7	0.53	800	200
Namtsy	-10.2	7.0	0.35	590	110
Kyzyl-Syr	-13.6	12.3	0.61	640	180
Nedzheli	-12.3	12.3	0.61	660	210
Yakutsk	-10.0	8.0	0.40	650	300
Sobo-Khaya	-11.3	9.9	0.49	350	270
Promyshlennyi	-10.4	7.6	0.38	360	210
Turukhansk	-9.1	9.1	0.46	420	150
Medvezh'e	-13.2	12.2	0.61	420	140
Yubileinoe	-11.0	11.0	0.55	380	140
Urengoi	-14.2	14.2	0.71	570	210

At present the mean annual temperature of the ground surface at all investigated points is  $7^{\circ}\text{C}$  -  $8^{\circ}\text{C}$  higher than that of air. Bearing this in mind, we estimate that 20,000 years ago the mean annual air temperature in the northern part of Western Siberia and in Central Yakutia ranged from  $-17^{\circ}\text{C}$  to  $-21^{\circ}\text{C}$ , which is approximately  $10^{\circ}\text{C}$  to  $13^{\circ}\text{C}$  lower than at present. This points to a pronounced warming trend which led to a decrease in the permafrost thickness everywhere in the U.S.S.R.

The calculated average rates of increase in the temperature (Table II) differ significantly, although for adjacent points they are almost the same (e.g., Vilyuisk, Kyzyl-Syr, Nedzheli). It is unlikely that there were differences in the warming trend within a relatively small area of Central Yakutia.

Most likely the warming trend was uniform. In this case the differences in  $\beta$  should indicate that the heat exchange between the ground surface and the atmosphere had its specific characteristics at each point in Central Yakutia. This applies first of all to vegetation and topsoil. The same is true of Western Siberia.

Our assumption concerning a gradual and continuous increase in the ground temperature from the middle of Sartanian glaciation and up to the present did not allow for the effect of the Holocene optimum on the development of permafrost which lasted for several thousand years. The reason for this is as follows. Firstly, thawing of permafrost from below depends on the temperature at the surface as long as the latter remains below  $0^{\circ}\text{C}$ . When this temperature rises above  $0^{\circ}\text{C}$ , permafrost begins to thaw from above. The permafrost base continues to move, as if the temperature at the surface is still  $0^{\circ}\text{C}$ , since the heat flux in permafrost will be equal to zero as long as the upper and lower phase boundaries do not merge, i.e., as long as permafrost does not thaw right through (see curve III in the Figure).

Secondly, the abundant geothermal data available at present do not contain any evidence that the Holocene optimum had any effect on the ground temperature. In Yakutia this was due to the fact that in the Holocene the ground temperature never rose above  $0^{\circ}\text{C}$ . Therefore any influence of this optimum was very soon obliterated by the slight cooling trend which has

persisted until the present. That this is indeed the case is indicated by the presence of ancient ice wedges near the surface of the ground.

We cannot explain the absences of any traces of the Holocene optimum in Eastern Siberia, in places where the ground temperature is now close to  $0^{\circ}\text{C}$ , unless we assume that this optimum was followed by an equally strong cooling trend.

If we assume that the average temperature of the ground surface during the Holocene optimum was  $2^{\circ}\text{C}$  higher than at present, this should have resulted in thawing to a depth of 60 - 80 m. Since the optimum was followed by a slight and brief cooling trend, this talik should be present still and have a temperature close to  $0^{\circ}\text{C}$ . In places where the present temperature of the ground surface is  $0^{\circ}\text{C}$ , the curves of type II (see Figure) should indicate the presence of the talik. In our analysis such curves were present (Turukhansk, Yubileinoe, Urengoi), but they showed no signs of the Holocene optimum. Future research should concentrate on the phase composition of the upper permafrost horizons where the temperature is  $0^{\circ}\text{C}$ .

According to some sources, unfrozen layers have been discovered in permafrost in the course of drilling. However, this could not be confirmed by any other methods, if we disregard the contemporary unfrozen zones the upper layers of which have a temperature below  $0^{\circ}\text{C}$ . No complex calculations are required to show that the age of a 10 to 15 m thick frozen layer is 200 to 400 years and not thousands of years.

The effect of the Holocene optimum on the thermal state of permafrost is still not fully understood.

REFERENCES

- BALOBAEV, V.T. 1971. Characteristics of geothermal processes in permafrost regions. In: Geokriologicheskie issledovaniya, Yakutsk, pp. 9-17.
- BALOBAEV, V.T., DEVYATKIN, V.N. and KUTASOV, I.M. 1973. Contemporary geothermal conditions of the existence and development of permafrost. Proc. II International Conference on Permafrost, Yakutsk. For English translation see U.S.S.R. Contribution to the II International Conference on Permafrost. NAS, Washington, D.C. 1978.
- DEI, U.A. 1974. Thermodynamics of simple media with a memory. "Mir", Moscow, 190 pages.
- KIND, N.V. 1974. Geochronology of Late Quaternary based on isotope data. Moscow, "Nauka", 255 pages.

CLASSIFICATION OF THE RELATIONSHIP BETWEEN CLIMATE AND  
PERMAFROST-CLIMATIC REGIONS

M.K. Gavrilova

Permafrost Institute, Yakutsk, U.S.S.R.

Climate is one of the basic factors in permafrost formation. The Earth's permafrost regions are restricted mainly to the polar and subpolar regions, and in southern latitudes, to high altitudes, i.e., to the cold regions.

Permafrost is a good indicator of climate, especially of changes in its territorial and temporal limits. A depth of hundreds or even thousands of metres reflects not only yearly (in the upper layer) but also epochal fluctuations in climate. The history of the earth's climate with its cooling and warming periods, the variety of present-day climates and the tendencies of both natural and man-made climatic changes are manifested in the temperature regime of the permafrost. Therefore, this regime becomes an indicator of the influence of all the climatic elements.

However, despite the fact that the relationship between climate and permafrost has been studied over a long period, many aspects of the problem are still far from solved. This is due as much to the complexity of the problem as to a number of objective and subjective circumstances. For example, there is a paucity of qualitative data and absence of exhaustive theoretical work. However, the development of contemporary geocryology requires that a number of questions be answered with regard to the interaction of climate and permafrost.

From the Russian, Soviet and foreign literature, it can be seen that the approach to the problem of correlating climate and permafrost has differed at various stages. This reflects a dialectic "spiral": a progression from a simple to the complex with an ensuing return to the original position but on a higher plane.

Scientific study of the correlation between climate and permafrost has developed from qualitative discussions of a global nature in the middle of the XVIIIth century to today's precise measurement of the heat balance in the microclimate.

It should be noted that the failure of several individual attempts to establish the relationship between climate and permafrost has led to some pessimism with regard to this problem. This failure can be explained by a lack of sufficient knowledge and the small amount of material available at that time.

Thus the "discrepancy" between mean air temperatures and the geocryological conditions in such concrete situations (wider than the microclimate) in the '30s and '40s suggested that the main factor in the occurrence and development of permafrost is not climate, but the geological conditions.

However, at meteorological stations (open location) air temperature is measured at a height of 2 m, but this does not typify conditions near the ground surface which is itself the upper limit for temperature distribution in the soil. From 0 - 2 m there are considerable changes in meteorological conditions. Moreover, it must be taken into account that the air temperature at this height is the result not only of vertical changes but also of a horizontal change due to the intermingling of neighbouring air masses. In short, the air temperature measured in the meteorological grid is not the result of the thermal processes at a given point, but of processes taking place over a relatively large area of tens or hundreds of kilometres.

The most significant factor in geocryology must be the more locationally restricted ground surface temperature rather than the air

temperature. Unfortunately, measurements of this phenomenon made within the meteorological grid are still not sufficiently reliable.

Thus, air temperature is not the most important criterion when estimating microclimatic conditions of a geocryological situation in specific locations. However, this phenomenon should not be overlooked when analyzing the general geocryological regime of large regions. In summation, the air temperature is nothing more than a measure of the thermal state or the result of a heat balance over a relatively wide area.

Recently there was a resurgence of this "pessimism" with regard to data on heat balance as well. This is primarily due to the difficulty of measuring these phenomena, and also to the fact that the indicators are not always in accordance with the geocryological conditions. As radiation features are related to astronomical factors, they have a tendency to latitudinal distribution to which permafrost conditions are not always subject. For example, the coldest ground is in northeast Yakutiya and not on the arctic coast and islands, where there is the smallest annual radiation balance.

Such a "disconcordance" is related to a breakdown of latitudinal climate zonality with all its consequences: circulation factors, climate formation, or the degree to which the climate is continental. A preliminary analysis of our research shows that general summer thawing regimes display the greatest concordance with the data on heat balance. The characteristics of winter freezing coordinate best with the intensity of temperatures. On the other hand, in microclimate research the heat balance characteristics are a good indicator of the thawing and freezing of earth materials on different types of terrain in a single locality. Data on the heat balance are also essential for any theoretical interpretations of the thermal processes which take place on Earth.

A significant "anomaly" in the permafrost distribution at a given latitude is brought about by the following factors: altitude above sea-level, terrain, and bodies of water. This also holds true for climate formation and its consequences.



Thus the exclusive role of climate in the occurrence and development of permafrost as an external cause of the thermal condition of the earth's crust, both in the past and at present, is not in doubt. However, the relationship between climate and permafrost is very complex. In some instances, the determining factor is the thermal regime which has become established over a large area; this can be adequately characterized by the air temperature. In other instances it is the local thermal regime. This demands detailed research into all components of the heat balance between the lithosphere, the soil and the atmosphere.

A differential approach to the climate-permafrost problem is needed in accordance with the specific tasks at hand. One occurrence or another of geocryological features could be connected with completely different genetic climatic phenomena. Before coming to any conclusions about the climate-permafrost relationship, there must be further investigation of the formation of the climate itself and likewise of its influence on the thermal or temperature regime of earth materials in general and of frozen ground in particular.

We propose a classification of the climate-permafrost relationship on the basis of six genetic types of climate: cosmic, planetary, macroclimate, mesoclimate, microclimate and soil climate (Table). Each type of climate influences the permafrost conditions in its own way, or has its own geocryological problems.

The cosmic climate (or more precisely the cosmic factors of climate formation) being determined by the interaction of the earth with other celestial bodies, points to a basic relationship between the sun and the earth's thermal regime. All major fluctuations in the earth's climate are dependent on the intensity of solar radiation, to which the cooling and warming trends of the Glacial and the Interglacial periods are also related. This in turn is reflected in the geocryological conditions. Formation of permafrost, its age, thickness and temperature regime at great depths are all related to the cosmic climate.

The planetary climate, or rather the climate of the planet Earth is to a large degree determined by its shape and rotation. With this are

associated the uneven exposure to radiation at different latitudes and the changes in the intensity of this radiation with season and time of day. This causes the general distribution of permafrost to be mainly within polar and sub-polar latitudes and brings about periodic fluctuations of temperature in the upper layers. The presence of the Earth's atmosphere, which becomes more dense with proximity to the Earth, is apparent from the weakening of solar radiation as it approaches the Earth's surface. The history of the formation of the Earth itself is not without importance. The Earth's internal heat determines the vertical limits of permafrost in the lithosphere.

The division of the earth's surface into oceans and continents leads to uneven heat distribution within a given latitude. It gives rise to circulation or heat transfer from the oceans to the continents. Since land has a lower thermal conductivity, it is cooled more easily than the ocean. This explains why permafrost is restricted to the continents. Further redistribution of heat on the continents is associated with the processes of the macroclimate or the climates of the continents. The greater the distance from the oceans the more severe become the climatic and geocryological conditions. This is intensified by the rotation of the earth. This also accounts for the west-east transfer of air masses or the strengthening of the continental nature of climate from west to east in the northern hemisphere. In Eurasia, for example, the Atlantic ocean exerts a significant influence, with which is associated the curvature of the continent's permafrost boundaries. This is also the case on the South American continent. In this way, the macroclimatic processes determine the character of the continental distribution of permafrost.

The mesoclimate is connected with large mountain formations, with bodies of water and with differing height above sea-level within one locality, et. It determines "abnormal" strengthening and weakening of permafrost in a given zone. Thus in the southern latitudes of Asia, Africa and South America, the permafrost phenomenon restricted to high mountains is a phenomenon of the mesoclimate. The less intense permafrost in earth materials under the northern seas and water basins is similarly associated with the mesoclimate.

The great variety of geocryologic conditions is brought about by microclimatic phenomena causing variations in temperature for different physico-geographic conditions in any one locality. The question of seasonal freezing and thawing of earth materials on different types of terrain and also under structures is connected with microclimatic processes.

And finally there is the soil climate or the climate of deep earth materials. All the former types of climate were external factors in determining the heat exchange between the earth's surface and the atmosphere. However, further redistribution of heat in the upper layer of the earth's crust, or the final formation of a temperature field at a given location, is dependent upon the lithological composition, on the structure and humidity of the earth materials themselves or on their thermo-physical properties. Therefore, when heat approaches the surface, the temperature regime will vary according to the type of local earth materia. For example, moist suglinoks , dry sands, etc. Subsurface water substantially modified the temperature field.

In the table, the numeration of types of climate is on the basis on distance from the sun. Each climate operates against a backdrop of the preceding type. However, this still does not account for the ensuing weakening of the influence. In individual cases, the second of two related climates can have the greater influence on the final geocryological outcome. For example, large quantities of subsurface water (a factor of soil climate) can bring about the formation of open taliks, even against a backdrop of the most severe macroclimate. However, the latter creates the potential. And so we acknowledge that ground water found in smaller quantities under the conditions of the relatively mild macroclimate of Southern Siberia could lead to the formation of an open talik, but would not do so in the severe macroclimate of Yakutia.

It is characteristic that some types of climate can play a dual role depending on the backdrop against which they exist, and also on the season. For example, forests in the northern and southern regions form "warm" or "cold" microclimates respectively. In winter, icings, bodies of water, etc., protect earth materials from freezing and in summer impede their warming up, etc.

Permafrost terrain can be divided into genetic climate-permafrost classes in accordance with the role that type plays in the climate permafrost relationship. Seven characteristic types are noted.

1. Macroclimatic field. Permafrost brought about by macroclimatic conditions. Meso- and macroclimatic relationships are intensified or weakened by the permafrost regime but are not a determining factor.

2. Meso-, macroclimatic field. In accordance with the macroclimatic conditions, the permafrost should be continuous, but under the conditions of the mesoclimate it can become discontinuous or island type, or might disappear completely. This is characteristic of the arctic continental shelf.

3. Macro-, meso-, microclimatic fields. All three can be decisive in either maintaining permafrost or causing it to disappear. These coincide with the northern discontinuous permafrost region.

4. Mesoclimatic field. On the basis of the macroclimate, there should be no permafrost. Its occurrence is related to the conditions of the mesoclimate. The microclimate is not a determining factor. It coincides with the southern, continuous permafrost region.

5. Meso-, microclimatic field. Both can be determining factors. Coincides with the southern discontinuous permafrost region.

6. Microclimatic field. Permafrost is not caused by either the macroclimate or the mesoclimate. Only the conditions of the microclimate are a determining factor.

7. The field of the corresponding soil (earth material) climate. This is not determined by present day macro-, meso- or micro-climatic conditions, but the established thermal regime of the earth materials helps to preserve the remains of ancient permafrost. Coincides with the distribution area of relict permafrost.

The methodology of solving these and other geocryological problems depends on the type of climate and its related geocryological phenomena.

Associated with the problem of climate-permafrost interaction are many real problems of present-day geocryology such as prediction of the natural trend of permafrost development on the earth, prediction of changes in permafrost conditions upon the opening up of terrain, protection of the environment, climate melioration, etc. At present, man is capable of consciously influencing the geocryological (temperature) conditions of the upper (seasonal) layers of earth materials by modifying the conditions of the microclimate (regulation of the insulating role of the Earth's surface). Partly with regard to the mesoclimate (creation of large reservoirs) and the soil (regulation of moisture retentive earth materials). On a more planetary and cosmic scale the processes of the macroclimate cannot yet be controlled by man.

And so, an overview of the climate-permafrost classification shows that the problem is a frequently encountered aspect of a wider problem, namely the sun-earth relationship. At the same time, it is so complex that it requires the work of specialists in different fields: astronomers, meteorologists, glaciologists, soil scientists, forestry specialists, agriculturalists, specialists in land improvement, specialist from all branches of engineering, etc. This important and extremely interesting subject of the interaction between the earth's climate and permafrost can only be conclusively resolved by the concerted efforts of the above mentioned and other specialists.

CLASSIFICATION OF THE CLIMATE-PERMAFROST RELATIONSHIP

1. COSMIC CLIMATE

Factor in climate formation	Effect on climate	Geocryological effect	Geocryological problem	Solution of problem	Present state of knowledge
1	2	3	4	5	6
1) Position of Earth in the cosmic system	Thermal interaction with planets, stars, cosmic space (other than the Sun)	Thermal influence on the Earth's temperature regime	Potential source of permafrost formation	Calculation of heat radiation from the planets, stars, cosmic dust, etc.	Work of individual astronomers
2) Sun's gravitational attraction	Dependence of the Earth's thermal state on the life of the Sun	As above	As above	Calculation of Earth-Sun relationship	As above
3) Thermal state of the Sun	Climatic changes of geological eras	As above	Permafrost intensity in earth materials of different geological eras. Age of permafrost	1) Estimate of intensity of solar radiation  2) Climatic reconstruction of glacial and interglacial eras according to palaeographic data  3) Climatic reconstructions on a basis of thickness and temperature of permafrost at great depth	Calculations by individual astronomers and meteorologists. Measurement by cosmic detectors  Work of individual palaeologists
4) Sun cycles	Cyclic fluctuations in climate (short term, long term)	As above	Cyclic fluctuations in intensity of permafrost in the upper layer	Analysis of cyclic fluctuations of the temperature regime of permafrost.	Individual projects of geothermal specialists

## 2. PLANETARY CLIMATE

1	2	3	4	5	6
1) Configuration (spherical shape of the Earth)	Latitudinal zonality of climate	Zonality of permafrost in earth materials from north to south	Nature and boundaries of permafrost distribution	Theoretical and field data according to type of permafrost distribution	Researched by climatologists and geocryologists
2) Annual rotation of Earth around the Sun on an inclined plane	Seasonal change of climatic indices	Uneven warming of Earth at different seasons	Daily amplitudes in temperature regime of permafrost in layers near the surface	Calculation and field measurements of the temperature of earth materials in layer prone to yearly fluctuation (15-20 m)	Determined by geothermal research by geocryologists
3) Daily rotation of Earth around its own axis	Daily change in climatic indices	Uneven warming of Earth's surface at different times of day	Daily amplitudes in temperature of permafrost in layers near the surface	Calculation and field measurement of the temperature of earth materials in layer prone to daily fluctuation (to 1 m)	Systematically determined at meteorological stations and occasionally during geocryological research
4) Presence of the Earth's atmosphere	Decrease in warming of Earth	Strengthening of permafrost	Intensity of permafrost	Calculation of receipt of Sun's heat through the atmosphere	Researched by geophysicists and specialists in geothermics

### 3. MACROCLIMATE

1	2	3	4	5	6
Division of the Earth's surface into oceans and continents	Division of climatic elements on continents on the basis of distance from the oceans (continental climate)	Expression of strict latitudinal zonality for sub-categorization of permafrost	Change of temperature in permafrost regime from West to East. The distribution boundaries of permafrost on continents	<p>1) Field research on nature of permafrost distribution under present-day conditions</p> <p>2) Coordination with climatic and actinometric studies</p> <p>3) Coordination with computation data for cold regions of continents</p>	<p>Dealt with in geocryological research</p> <p>Climatic handbooks and atlases for hydro-meteorology</p> <p>Data and maps on the heat balance of continents and of individual regions studied by climatologists, etc.</p>



#### 4. MESOCLIMATE

1	2	3	4	5	6
1) Height of location above sea level	Occurrence of vertical climatic zones	Vertical geocryological zones	Geocryological inversions	Geocryological theoretical and field research at high altitudes	Regional projects of geocryologists
2) Large relief features	Dependence of climatic conditions on exposure and type of relief	Complexity of geocryological conditions in mountain regions	Type of permafrost distribution in earth materials, ridges and large valleys	Theoretical and field research in mountains and valleys	As above
3) Large bodies of water	Modification of climatic conditions	Modification of geocryological conditions under reservoirs and along coastlines	Occurrence of permafrost under reservoirs and their vicinities	Geocryological theoretical and field research on continental shelves, large rivers and lakes	As above

## 5. MICROCLIMATE

1	2	3	4	5	6
1) Vegetation cover	Decrease in thermal exchange	Winter warming and summer cooling trends	Special feature of freezing and thawing of soil under large forest stands and other vegetation covers	Special microclimatic, thermal balance and geothermal observations of forests in areas with or without vegetation cover	Individual projects on geocryology, forestry, agriculture, geobotany, etc.
2) Average and small relief features	Difference in meteorological regime depending on exposure, gradient and relief feature	Variation in meteorological regime depending on exposure and relief features	Special freezing and thawing features of soils in average and small valleys	Observations of special microclimatic, heat balance and geothermal balance on slopes, watersheds and in average and small valleys	Individual projects in geocryology, climatology, physical geography, etc.
3) Average and small reservoirs	Change of meteorological regime in the vicinity of the body of water and in the layer immediately below it	Warming trend in winter and cooling trend in summer	Formation of talik zones under reservoirs and in their vicinity	Special microclimatic heat balance, thermophysical and geothermal observations above bodies of water, in expanses of water and in deposits on lake bottoms	Individual projects in lake research and geocryology

## 5. MICROCLIMATE (Cont'd)

1	2	3	4	5	6
4) Glaciers	Cooling of surrounding area, decrease in heat exchange of earth materials below glaciers	Warming trend in winter and cooling trend in summer	Phenomenon of permafrost under glaciers	Special micro-climatic, heat balance and geothermal observations in glacial regions	Individual projects of glaciologists, meteorologists and geocryologists
5) Icings	Warming of surrounding area in winter and cooling influence in early summer	Warming trend in winter and a delaying of the warming trend until the icing has disappeared	Formation of talik zones in valleys with icings	Special micro-climatic heat balance, hydro-thermal etc., observations in valleys with icings	Individual projects of hydrologists and geocryologists
6) Engineering constructions	Distortion of the established meteorological regime	Thawing under heated buildings and cooling under others	Formation of a "thaw basin" and raising of permafrost table	Computation and field research under structures	Individual projects in permafrost engineering

## 6. SOIL (EARTH MATERIAL) CLIMATE

1	2	3	4	5	6
1) Lithological composition	Heat transfer in deep earth materials	Thermal regime of earth materials	Formation of temperature regime	Calculation and field thermo-physical research	Individual projects by specialists in thermodynamics, geothermodynamics and geocryology
2) Humidity (ice-content) of rocks	As above	As above	As above	Field determination of humidity (ice content) of earth materials	Individual projects in agrometeorology soil science and geocryology
3) Subsurface water	Change in temperature of earth materials	Heating of talik zones	Formation of talik zones	Theoretical and field research	Individual projects of geocryologists
4) Chemical processes	As above	Thawing or freezing of rocks	Anomaly of the temperature field	Theoretical and laboratory research	Individual projects of geochemists



THE EFFECT OF DEVELOPING A TERRITORY ON THE HEAT BALANCE AND THE THERMAL  
AND MOISTURE REGIME OF THE GROUND IN THE NORTHERN PART OF WESTERN SIBERIA.

N.G. Moskalenko, V.B. Slavin-Borovskii and Yu.L. Shur

All-Union Research Institute of Hydrogeology and Engineering Geology, Moscow  
and

N.A. Lazareva, S.P. Malevskii-Malevich  
Main Geophysical Observatory, Leningrad

Studies of the susceptibility of permafrost to changes resulting from industrial and economic activity are made necessary by the requirements for developing the vast territories of the northern part of Western Siberia and for predicting the engineering and permafrost conditions in areas undergoing development.

The studies are conducted in two main directions: a study of the heat balance, and observations of the state of the permafrost and of the seasonally thawed layer in different terrain conditions.

The components of the heat balance and of the thermal and moisture regime of the ground are studied in test areas under undisturbed terrain conditions and at artificially prepared sites (sites devoid of vegetation).

Parallel observations at undisturbed and disturbed sites make it possible to estimate the changes in the conditions of heat exchange and thawing with removal of surface vegetation. Such studies were conducted in 1975 and 1976 in the forest tundra zone in shrub covered, mossy and lichenous peatlands, in patchy shrub covered, lichenous open areas of predominantly larch and in patchy shrub covered, mossy and lichenous tundras.

Studies of the thermal and moisture regime of the layer of seasonal thawing have been conducted since 1971 in the northern taiga, the southern and northern forest tundra and the tundra. We now have results for more than 200 microfacies of the typical natural landmarks of these zones (Moskalenko and Shur, 1975b; Slavin-Borovskii, 1975).

In a number of the areas helicopter surveys of the albedo and the radiation temperature of the active surface were conducted. The resulting information makes it possible to estimate the variability of conditions at the surface in different natural complexes (Malevskii-Malevich, 1965, 1968).

The above-described activities are carried out in the summer months by expeditionary detachments. In winter, intermittent observations of the snow cover are made in the detachments' areas of operations. The ground temperatures are observed in boreholes the year round (at intervals of 5 to 15 days).

When conducting the observations and during their subsequent processing, standard procedures are used wherever possible.

In the heat balance studies provision was made for a multiple set of observations in order that all of its components could be determined independently. For measuring the ground temperature a special thermometric unit incorporating a non-heat conducting core was used with resistance thermometers installed at predetermined depths. The non-uniformity of the subjacent surface was accounted for by an additional thermometric unit and a thermocouple. In gradient and actinometric measurements the non-uniformity of the surface is automatically taken into account.

In addition to the normal four times a day measurements a further series of measurements were conducted six times a day. At the leeward extremity of the disturbed site additional observations were conducted at a height of 2.0 m.

Direct measurement of the heat fluxes in the ground took the form of an experiment. The reduced calculated values were derived from thermometric investigations.

Also by way of a test of the new procedures, empirical relations between the heat fluxes in the ground and the global radiation were derived from the results of integration.

An estimate of the accuracy of measuring the depth of thaw was made on the basis of multiple samplings with a probe. The calculations of the distribution pattern of the derived values showed that for fairly large samples with a volume close to that of the general population ( $n = 100; 50$ ) the dispersion  $S^2$  is 100 with a measuring accuracy of 2.5 cm. A tenfold sampling is consequently accompanied by a mean deviation from the general population of the order of 10% of the measured value (0.5 - 1.0 m). The multiple sampling of the depths of thaw is governed by its probability character (Grechishchev, 1975).

#### The heat balance

The information derived from parallel observations at disturbed and undisturbed sites is used for calculating the components of the heat balance. In areas containing patches the heat flux in the ground and the depth of thaw beneath clayey-silty patches far exceed these values beneath the vegetative cover. Accordingly, the mean values of the flux were used in the calculation. These consisted of the weighted values for the patches and the vegetation. The weight of the patches was taken to be equal to the proportion of them in the total surface area, i.e., about 20%. The results of the measurements and the calculations make it possible to determine the sums of the heat balance components throughout the period of thawing. In Tables I and II these data are adduced for two areas during the 1975 period of thawing.

In the Tables the following symbols are used: R is the radiation balance, LE are the expenditures of heat on evaporation, P is the turbulent heat flux, B is the heat flux in the ground,  $\Delta$  is the heat balance discrepancy.

The closure condition of the heat balance can serve as a check on the reliability of the data presented, since all of its components are determined independently. An exception are the data for the disturbed site



in the peatland where additional procedural difficulties made it impossible to derive reliable results for the values of LE and P. In this case they were determined from a prior assumption of the balance closure on the basis of the data for R and B. At all of the remaining sites, as follows from the data adduced in the lower line of Tables I and II, the resulting discrepancy of the heat balance  $\frac{\Sigma(LE + P + B) - \Sigma R}{\Sigma R}$  does not exceed 6% of the value of the radiation balance. This attests to the absence of noticeable systematic errors in the measurements and calculation systems employed. At the same time the random errors in the measurements lead to much larger values of the discrepancies when averaging for shorter time intervals. Thus in the case of the monthly totals they can be as high as 20%. Therefore, correct determination of the values of the heat balance is only possible on condition that systematic measurements are carried out throughout the entire period of seasonal thawing.

The possibility of using information derived from short series of measurements in order to calculate the heat balance is problematic. The correlation between the radiation balance and the expenditures of heat on evaporation proved to be very weak:  $r(R, LE)$  ranged from 0.25 to 0.67 for the undisturbed sites and from 0.15 to 0.54 for the disturbed sites. The evaporation is evidently limited by the energy capabilities and by the conditions of moisture transport to the surface. It is probable that only under conditions of extreme moisture (bogs and artificial covers) that short series can yield sufficient information for studying the structure of the heat balance.

The comparison between the values of the heat balance components at the two sites under undisturbed conditions illustrates the local differences caused by the various types of subjacent surface. Most noticeable are the differences in the distribution of the quantities of heat expended on heat exchange between the surface and the atmosphere in the clear and latent form (the P and E correlation). Whereas when the conditions are those of a lichenous cover in suglinoks a turbulent heat flux is the predominant component, in the case of mossy vegetation in peatlands the bulk of the heat is expended on evaporation. In suglinoks the heat fluxes in the

TABLE I

Heat balance of shrub-covered lichenous open areas of predominantly larch, Kcal/cm<sup>2</sup> for the period of seasonal thawing (July 1 - September 29, 1975).

Month	Undisturbed site						Disturbed site					
	R	LE	P	B	LE+P+B	Δ, %	R	LE	P	B	LE+P+B	Δ, %
VII	6.42	1.62	3.52	1.19	6.34	-1	6.39	2.17	2.22	1.69	6.08	-5
VIII	4.07	1.53	2.18	0.81	4.52	+11	4.65	3.17	1.89	0.50	5.57	+20
IX	2.06	1.36	0.69	0.37	2.42	+18	2.30	1.47	0.26	0.20	1.92	-18
Σ	12.54	4.52	6.39	2.37	13.28		13.34	6.80	4.37	2.39	13.56	
Mean djurnal, cal/cm <sup>2</sup> day	140	50	71	26			148	76	49	27		
Heat balance discrepancy for the season						+6%						+2%

TABLE II

Heat balance of shrub-covered, mossy, lichenous peatland, kcal/cm<sup>2</sup> for the period of seasonal thawing (July 4 - September 25, 1975).

Month	Undisturbed site						Disturbed site			
	R	LE	P	B	LE+P+B	Δ, %	R	LE	P	B
VII	5.82	2.52	2.20	0.98	5.70	-2	6.70	3.98	1.20	1.52
VIII	3.74	2.48	1.13	0.38	3.99	+5	4.44	3.87	-0.09	0.46
IX	1.95	1.76	0.23	0.26	2.25	+16	2.48	1.40	0.77	0.30
Σ	11.52	6.77	3.56	1.62	11.95		13.62	9.24	1.89	2.29
Mean djurnal, cal/cm <sup>2</sup> day	137	81	42	19			162	110	22	27
Heat balance discrepancy for the season						+4%				

ground are appreciably greater than in peats and the depths of seasonal thawing are in agreement with this. The differences in the radiation balance are inconsequential.

In estimating the effect of a disturbance in the properties of the subjacent surface on the heat balance the following conclusions seem to be most important.

When development is in progress the radiation balance changes very little with the denudation of suglinoks (6%) and very substantially in the case of peatlands (18%). This is because in the latter case the influence of two factors is being felt: a pronounced decrease in both the albedo (from 15-17% to 10-12%) and the effective radiation, whereas when removing a lichenous cover from the surface of suglinoks the albedo remains practically unchanged.

The values of the turbulent fluxes of heat and moisture change markedly with development. In the types of surfaces discussed, with elimination of the vegetation an increase in the moisture fluxes, amounting to several tens of percent, and a decrease in the heat fluxes is typical. Of greatest importance from the standpoint of the cryogenic processes are the changes in the heat flux in the ground. If the total flux values for the season are considered, the marked changes in the conditions for the peatlands are particularly striking (an increase of B by almost one and a half times during development). At the same time, in the case of the suglinoks cumulative differences for the season are not manifested. If the individual periods of the season of thawing are considered, however, it then becomes evident that when development is in progress there is a marked increase in the heat fluxes in the ground during the initial period of thawing (July) with the result that the rate of thawing at the disturbed site is much higher than at the undisturbed site, although the ratio between the fluxes then becomes reversed and throughout the season as a whole these differences almost disappear.

From the results of the instrumented observations in 1976 the dependences between some of the components of the heat balance and the total (incoming) radiation are derived.

Thus, in comparing the graphs reflecting the changes in the daily totals of short-wave radiation and the mean diurnal values of the heat flux in the ground occurring throughout the summer of 1976, it can be seen that

there is an overall trend towards an increase in these values, while in individual time segments they can change oppositely.

In order to ascertain the relations between the incoming radiation  $Q$  and the radiation balance of the undisturbed  $R_u$  and disturbed  $R_d$  sites in the northern forest tundra the correlation coefficients of these values were calculated and the following linear empirical equations were formulated:

$$R_u = 0.08 + 0.440 Q; r = 0.703$$

$$R_d = 0.11 + 0.490 Q; r = 0.786$$

Similar equations were derived for the heat fluxes in the ground:

$$B_u = 0.007 (1 + 4.3 Q); r = 0.723$$

$$B_d = 0.027 (1 + 5.4 Q); r = 0.835$$

It is typical that the value of  $B$  correlates better with  $Q$  than does  $R$  and the values of  $R$  and  $B$  are better for the disturbed site than for the undisturbed site. The graphs of these dependences are presented in Figure 1.

Figure 1

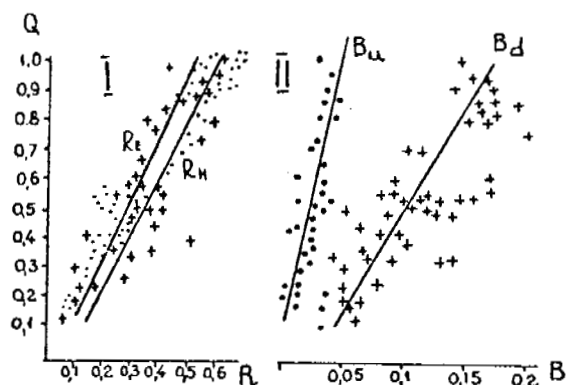

Empirical dependence of the radiation balances  $R$ (I) and heat fluxes in the ground (II) on the short-wave radiation  $Q$  at 14 hours ( $\text{cal}/\text{cm}^2 \text{ min}$ ).

The fact that  $R_d > R_u$  and  $B_d > B_u$  during daylight, as determined from the derived dependences, emphasizes the displacements in the heat balance occurring with removal of the vegetative cover. On considering the arbitrary remainders of the radiation balance  $R-B$  it follows that when  $Q > 0.1 \text{ cal/cm}^2 \text{ min}$  the expenditures of heat on evaporation and the turbulent heat exchange are higher at the undisturbed site. These dependences, however, were derived for the "dry" summer of 1976 when the role played by evaporation in the heat balance was evidently less than normal.

The use of summarizing recorders for measuring  $Q$  and  $B_u$  made it possible to trace the relations between the three hourly (during the daylight period) and diurnal sums of these values.

Thus, for the three hourly sums of  $\sum_3 B$  and  $\sum_3 Q$  the findings were  $r = 0.64$  and the following empirical linear dependence:

$$\sum_3 B = 3.2 + 0.154 \sum_3 Q.$$

For the daily sums the dependence is also linear:

$$\sum_{\text{diurnal}} B = 0.175 \sum_{\text{diurnal}} Q - 2.6$$

The correlation coefficient  $r = 0.749$ . The values of  $\sum_{\text{diurnal}} B$  and  $\sum_{\text{diurnal}} Q$  and the graphs of the empirical dependences are presented in Figure 2.

Figure 2

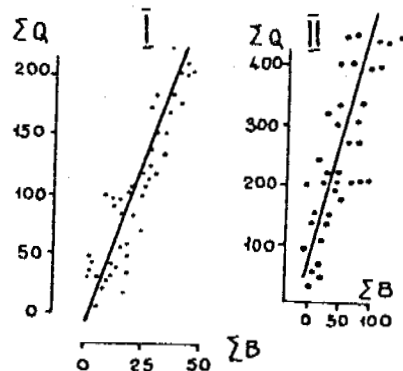

Relation between the (I) three-hourly and (II) diurnal sums of incoming radiation  $\Sigma Q$  and the heat flux in the ground  $\Sigma B$ ,  $\text{cal/cm}^2$  for the summer of 1976.

The information adduced characterizes the state of the disturbed sites immediately after denudation of the ground. The structure of the heat balance at these sites is subject to further changes occasioned by the natural and anthropogenic processes transforming the site. Here it is necessary to mention a new effect on the surface, the development of the microrelief, the dynamics of moistening, the soil processes and other processes of biological origin, and the general direction of development of the original and manmade terrain.

Time consuming and complicated heat balance studies can only be conducted in certain of the wide variety of subjacent surfaces occurring in regions under development. For this reason a very urgent task is that of describing the heat balance conditions for a particular territory characterized by a variegation of terrain. For this purpose, steady state observations are supplemented by occasional surveys along special routes. These surveys are accomplished both by normal surface observations and by helicopter. Helicopter surveys make it possible to obtain the spatial distributions of the albedo and temperature values at the surface. Measurements of 8 types of natural territorial complexes (NTC) indicated closely similar values of the albedo (15-17%) for the overwhelming majority of types of subjacent surface. Only two of them are distinguished by a noticeably lower albedo: pine forest and scorched peat mounds, in respect of which the surface temperature during the dayling hours is 5-10<sup>0</sup> higher than in the other NTC's. The data obtained make it possible to estimate the values of the radiation balance of various NTC's and the variations of these values, amounting to as much as 15%.

Presented in Table III are the following results of the radiation survey by helicopter:

A is the albedo,  $t$  - the surface temperature,  $D$  - the dispersion of the corresponding values within each variety of terrain, and  $R_n/R_0$  - the ratio of the calculated radiation balance in the  $n$ th terrain to the radiation balance of the control site. The  $R_n/R_0$  ratio was calculated from the formula  $R_n = R_0 + Q(A_0 - A_n) + I_0 - I_n$  for the control site:

$$Q = 0.90 \frac{\text{cal}}{\text{cm}^2\text{min}}; A_0 = 15\%, t = 25^{\circ}\text{C}$$

and the effective radiation:

$$I_0 = 0.15 \frac{\text{cal}}{\text{cm}^2\text{min}}, \quad R_0 = 0.61 \frac{\text{cal}}{\text{cm}^2\text{min}}$$

TABLE III

Results of helicopter surveys of the radiation and albedo

Natural complexes (NTC)	A, %	D(A)	t, °C	D(t <sup>0</sup> )	R <sub>n</sub> /R <sub>0</sub>
Flat shrub-covered, mossy, lichenous peatland	15.7	0.4	26.4	-	1.03
Sedge and Sphagnum bog	15.5	0.7	24.6	0.9	1.01
Peat and mineral mounds and ridges containing shrub-covered lichenous open areas of predominantly cedar	15.1	0.5	33.1	1.8	0.88
Mineral mounds and ridges containing shrub-covered lichenous open areas of predominantly cedar	16.0	-	33.8	-	0.88
Sparse forest consisting of birch and spruce	11.8	1.3	27.7	2.1	1.01
Open area consisting of larch, spruce and birch	16.3	0.2	26.4	1.5	1.03
Coarse hillocky shrub-covered lichenous peatland	16.4	1.2	24.4	1.1	1.01
Denuded peat mounds	13.0	1.1	29.3	3.4	1.02

The temperature regime of the ground

Studies of the temperature regime of the layer of seasonal thawing in various natural complexes have shown that it is subject to significant changes. These changes are mainly associated with the non-uniformity of the microrelief and the vegetative cover under undisturbed conditions and with the disturbance which is caused to the properties of the ground and the subjacent surface in areas undergoing development. Presented in Table IV are data on the temperature of the surface and the upper levels of the soil and ground to a depth of 3 m throughout the summer for five of the most widely distributed NTC's in two natural zones (the northern taiga and the forest tundra).

TABLE IV

Temperature regime of earth materials in various natural complexes under undisturbed and disturbed conditions.

1	2	3	4	5	6	7	8	9	10	11	12	13	14
Forest Tundra, 1975													
A	0.85												-3.2
a		10.1	17.3	2.6	8.7	6.6	4.0	3.0	-0.4	-1.7	-2.6		0.51
b		10.8	21.9	2.5	7.0	5.3	3.5	2.9	-0.7	-1.9	-2.6		0.63
B	1.3												-3.0
a		9.5	16.3	2.4	8.7	7.1	4.0	1.5	-0.4	-2.0	-2.6		0.51
b		10.7	22.9	1.2	5.4	3.6	2.5	1.4	-1.0	-2.2	-2.9		0.44
C	1.6												-3.0
a		10.3	21.9	1.8	7.7	5.9	4.7	1.4	-0.6	-1.9	-2.5		0.48
b		10.0	21.1	1.0	5.4	3.0	-	1.3	-0.8	-2.0	-2.6		0.38
D													-2.0
a	0.0	9.9	19.2	4.2	8.6	8.3	8.0	7.2	1.7	-0.5	-1.5		1.26
b	0.15	9.7	19.3	2.7	7.2	5.1	4.8	3.6	-	-	-		1.2
c	0.05	10.6	21.6	1.3	5.6	4.2	-	3.5	1.8	-1.1	-1.8		1.1
E													-2.0
a	0.0	10.2	18.5	4.3	9.0	9.0	8.0	7.4	1.9	-0.9	-1.7		1.4
b	0.02	10.8	19.1	4.1	8.3	7.7	7.0	7.1	1.3	-0.8	-1.5		1.3
Northern taiga, 1973													
F	1.05												-0.8
a		11.0	22.6	4.5	10.5	9.0	7.5	4.9	-0.1	-0.4	-0.6		0.6
b		11.0	25.9	2.4	6.9	4.6	3.4	2.6	-0.4	-0.6	-0.7		
G	1.0												-0.8
a		11.8	20.6	4.9	9.2	7.9	6.1	5.4	-0.1	-0.5	-0.8		0.7
b		11.4	21.4	5.5	9.5	8.4	6.1	6.0	-	-	-		0.6
H													-0.4
a	0.2	11.5	23.9	3.7	8.5	7.0	5.1	4.5	3.8	0.0	-0.2		1.3
b	0.1	12.1	26.1	2.2	6.9	4.9	4.3	3.7	2.5	0.0	-0.2		1.15
I	0.0	13.1	25.5	5.1	12.4	12.1	11.0	10.1	5.8	1.0	-0.4	-0.4	2.35
J	0.7												-0.7
a		11.7	23.0	4.1	9.7	7.4	5.0	3.4	-0.1	-0.5	-0.6		0.59
b		12.4	30.1	2.5	7.1	4.4	3.2	2.3	-0.4	-0.5	-0.6		0.5
K	0.4	12.0	21.5	4.1	10.1	8.4	7.2	6.1	-0.1	-0.5	-0.5	-	0.74

Explanation:

1 - Natural complexes: A - shrub-covered lichenous peat mounds (a - shrub-covered, green mossy, lichenous hummock; b - shrub-covered, lichenous hummock); B - flat, shrub-covered lichenous peatland (a - shrub-covered, lichenous hummock, b - lichenous strip between hummocks); C - flat shrub-covered, lichenous, Sphagnum peatland (a - shrub-covered, sphagnum



TABLE IV

Explanation: (cont'd)

hummock, b - lichenous strip between hummocks); D - smoothed area on northern slope of hill with patchy shrub-covered, lichenous open area consisting predominantly of larch (a - patch of suglinok, b - shrub-covered lichenous hummock, c - lichenous strip between hummocks); E - the same area with vegetative cover removed (a - suglinok, b - suglinok in which peat has formed); F - flat, shrub-covered, sphagnous, lichenous peatland (a - shrub-covered lichenous hummock, b - lichenous strip between hummocks); G - the same peatland with vegetative cover removed (a - hummock, b - strip between hummocks); H - mineral mound with shrub-covered, lichenous open area consisting predominantly of cedar (a - shrub-covered lichenous hummock, b - lichenous strip between hummocks); I - the same mound without vegetation and with sand on the surface; J - mineral and peat mound with shrub-covered, sphagnum, lichenous open area consisting predominantly of cedar (a - shrub-covered, sphagnum hummock, b - lichenous strip between hummocks); K - the same area without vegetation and with peat on the surface. 2 - Thickness of peat layer, m. 3 - 12. Temperatures of earth materials (mean values for July-September) at the surface: 3 - mean, 4 - maximum, 5 - minimum at the following depths in m: 6 - 0.05, 7 - 0.1, 8 - 0.15, 9 - 0.2, 10 - 1.0, 11 - 2.0, 12 - 3.0. 13 - Main annual temperature at a depth of 10 m. 14 - Thickness of seasonally thawed layer, m.

These data indicate that in undisturbed conditions where there is a layer of peat extending to a depth of 10 cm and more, the temperatures of the upper layers of the topsoil are fairly close to one another, notwithstanding the differences in the composition of the subsoil and the parent rocks from which the soil is formed, as compared with the areas devoid of surface vegetation. At the same time the temperatures of the upper layers of topsoil in areas of limited extent where there is no vegetation (non-sorted circles) differ only slightly from the temperatures of the much larger areas under development. This indicates that the temperature of the upper layers of the topsoil depends in large measure on the properties of the near-surface layer and on the local properties of the subjacent surface.

It has been found that a fairly stable relation obtains between the sums of the summer air temperatures and the denuded surfaces of the ground. Thus, in the peatlands, bogs and supersaturated sands of northern slopes of embankments the relation between the sums of the summer surface temperatures and the sum of the air temperatures is 1.05; in the peaty surfaces of heaving hummocks it is 1.1; in dry sands 1.2 and on the southern slopes of the embankments 1.3.

The depth of seasonal thawing depends heavily on the composition and properties of the ground constituting the active layer. Thus, at closely similar temperatures of the surface and upper layers of topsoil the depth of seasonal thawing can differ by two or more times. In peatlands, after removal of the vegetative cover, as a rule there is a slight increase in this depth. The largest increase in this value as a result of development is observed in sandy areas.

In summer, the influence of the microrelief and the mosaic pattern of the vegetative cover on the temperature regime of the soil is traced within the facies to a depth of 1 m.

Clearly when discussing the temperature regime of the subjacent strata the boundary at this depth can be taken to be general for the facies.

The region of our investigations lies within the zone of surplus moisture. In June and July, however, evaporation often exceeds precipitation, which leads to drying out of the upper part of the active layer. For example, in the course of the summer, in the upper layer measuring 5 cm thick and situated in the northern taiga in a flat peatland covered by shrubs, Sphagnum and lichens, in undisturbed conditions the reserves of moisture vary by one and a half times (17 to 24 mm), and in areas where the vegetative cover has been removed - by almost three times (10 to 28 mm). In peats the seasonal variations in the moisture content of the soil embrace a layer measuring 30 to 40 cm.

In sands, removal of the vegetative cover leads to a decrease in their moisture content throughout the whole of the layer of seasonal thawing. Thus, the reserves of moisture in a layer measuring 0.5 m are 130 to 140 mm in an area covered by shrubs and lichens, and 60 mm in an area without vegetation. In all cases an increase in the moisture content is noted immediately at the boundary of seasonal thawing (Dostovalov and Kudryavtsev, 1967).

Snow gauging observations indicate that the distribution of the snow is quite intricately linked with the nature and extent of the disturbance caused to the terrain. In peat or mineral earth materials

without a vegetative cover the density of the lower layers of snow is much higher than it is in undisturbed conditions. Furthermore, in a number of areas the snow was seen to disappear later from ground devoid of vegetation. In open places removal of the vegetative cover usually leads to a decrease in the thickness of the snow cover. Near embankments of linear installations the snow cover is much less uniform.

The variation in the mean annual ground temperatures, especially in the initial years following the development of a territory, is associated with changes in the thickness and density of the snow cover. As will be seen from Figure 3, removal of the vegetative cover often leads to a decrease in the mean annual temperature of the ground. In those areas, however, where by virtue of the local conditions, removal of the vegetation has not caused a decrease in the thickness and a substantial increase in the density of the snow, the mean annual temperature of the ground rises. It should be noted that the absence of methods of predicting changes in the characteristics of the snow cover associated with the development of a territory reduces the accuracy of forecasting procedures.

Figure 3

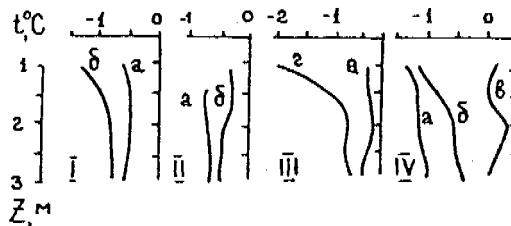

Mean annual temperatures of the ground at depths of  $z$ , in m in (a) undisturbed and (b, c and d) disturbed conditions.

b - without vegetative cover; c - without a layer of peat;  
d - without vegetative and snow covers.

I - flat peatland; II - mineral and peat mound;  
III - mineral mound - 1; IV - mineral mound - 2.

The study of the thermal and moisture regime of the ground in areas where there is no evidence of such processes as erosion and thermokarst showed that removal of the vegetative cover and destruction of the peaty

layer, which has no noticeable effect on the relief and the regime of the surface waters, leads to an increase in the depth of seasonal thawing. This can be very substantial in some types of NTC's. At the same time, these disturbances give rise to changes in the properties of the active layer and in the thickness and density of the snow cover, with the result that in the majority of cases the mean annual temperature of the ground does not rise.

The processes involved in the thawing and neogenesis of permafrost take place slowly and do not evolve to the point where the influence of the restoration of the terrain components that were disturbed during development begins to be manifested. Foremost among these is the vegetation (Moskalenko and Shur, 1975a). Because of the slow rate of change the thermal state of the ground is easily checked and can be controlled at any stage in the use of an installation.

Our study also indicates that the fulfillment of a small number of on the whole, easily accomplished requirements for studies in permafrost would substantially decrease both the range of variations in the depth of seasonal thawing and the temperature of the ground and the amplitude of the changes occurring in the terrain as a whole. They obviously include the well known requirements for laying winter roads and linear installations in such a way that the snow is compacted rather than cleared. At the same time, removal of the peat in areas containing permafrost cannot be regarded as desirable.

## REFERENCES

- DOSTOVALOV, B.N. and KUDRYAVTSEV, V.A. General Geocryology. Moscow State University, p. 404, 1967.
- GRECHISHCHEV, S.E. Optimal precision of geocryological forecasts based on physical and mathematical considerations. - "Methods of geocryological investigations." Moscow, pp. 4-16, 1975.
- MALEVSKII-MALEVICH, S.P. Procedures of conducting actinometric observations from a helicopter. Transactions of the Main Geophysical Observatory, No. 161, 1965.
- Idem. 1968. Temperature and radiation regime of irrigated rice fields. - "Actinometry and atmospheric optics." Tallin.
- MOSKALENKO, N.G. and Shur, Yu.L. Forecasting changes in the terrain in areas of permafrost under development. "Methods of geocryological investigations", Moscow, pp. 34-45, 1975a.
- Idem. 1975b. The temperature regime of the surface and the layer of seasonal thawing on the lacustrine alluvial plains of the northern part of Western Siberia. - "Geocryological investigations", Moscow, pp. 76-96.
- PAVLOV, A.V. The heat exchange between freezing and thawing ground and the atmosphere. Moscow. "Nauka", p. 296, 1965.
- SLAVIN-BOROVSKII, V.B. Some results of a comparative study of undisturbed and disturbed areas of terrain in the northern taiga. - "Methods of geocryological investigations." Moscow, pp. 45-53, 1975.

## THERMAL PHYSICS OF PERMAFROST TERRAIN

A.V. Pavlov

Institute of Permafrost Studies, Yakutsk, U.S.S.R.

The thermal physics of landscapes reveal the relationship between individual components of a landscape (terrain) or between various terrain types. Of central importance here is the energy (heat) balance method, which makes it possible to describe quantitatively the processes of heat- and mass-exchange in the terrain of the earth's crust. The study of the thermal physics of terrain types focuses on the near-surface layer of the atmosphere, the surface cover (snow, vegetation, water, etc.) and earth materials. The essential difference and also the complexity which characterizes thermophysical studies in permafrost terrain is that in this case it is necessary to take into account the seasonal phase transformations of ground moisture.

This integrated approach in studying the processes of heat- and mass-exchange in terrain types is typical in geocryology and is often lacking in the allied sciences of hydrometeorology, geothermal investigations, the physics of the near-surface layer, etc. (Pavlov, 1975). The most effective method of understanding the thermophysical processes is to conduct long-term observations of all of the heat exchange parameters in the system comprising the ground, the surface cover and the atmosphere in terms of their daily, seasonal and yearly variations. The author has conducted studies of this type since 1957 at the V.A. Obruchev Institute of Permafrost Studies (Moscow) and also at the Institute of Permafrost Studies of the Siberian Branch U.S.S.R. Academy of Sciences (Yakutsk). The studies encompassed a region of seasonal ground freezing (Zagorsk) and areas with unstable (Vorkuta, Igarka) and stable (Yakutsk; Syrdakh, 100 km to the northeast of Yakutsk; Solenaya, 300 km westwards of Noril'sk) permafrost (Pavlov, 1965, 1975).

One of the most important components of the terrain is the snow cover. In comparison with other natural formations, it is distinguished by its seasonal character and the extreme variability of its properties, texture and thickness with space and time, which together characterize its effect on the heat exchange between the ground and the air. At permanent installations the following dominant types of heat exchange in the snow cover were experimentally studied: conduction, diffusion and the penetration of short wave solar radiation (Pavlov, 1975). Despite prevailing opinions, an abrupt variation (up to twofold) was revealed in the heat and mass exchange of the snow cover in the 0°C to -30°C temperature range. Processing the experimental data made it possible to obtain the following formulae for determining the coefficients of macroscopic diffusion  $D$  and thermal conductivity  $\lambda$ :

$$D(t) = D(0) + at + bt^2, \quad (1)$$

$$\lambda(\rho, t) = \frac{\lambda_{air} V_{air} + \lambda_{ice} (1 - V_{air}) F}{V_{air} + (1 - V_{air}) F} \times [1.00 + 1.18 \exp(0.15t)] \quad (2)$$

where

$$D(0) = 0.92 \times 10^{-2} \text{ m}^2/\text{sec};$$

$$a = 2.91 \times 10^{-2} \text{ 1/}^\circ\text{C};$$

$$b = 5.61 \times 10^{-4} \text{ 1/}(\text{}^\circ\text{C})^2;$$

$\lambda_{air}$ ,  $\lambda_{ice}$ ,  $\rho_{air}$  and  $\rho_{ice}$  are the coefficients of thermal conductivity and the density of the air and ice respectively;

$$F = 0.15 - 0.25;$$

$$V_{air} = 1 - \rho_{solar}/\rho_{ice}.$$

The first factor in the right hand part of formula (2) characterizes the heat transfer by true conduction, the second - that which is caused by diffusion of water vapour. In the central regions of the European part of the U.S.S.R., throughout the whole of the winter, diffusion accounts for about 1/4th of the total heat transfer  $q_s$ . In the northern regions, where the winter temperatures are lower during this season, heat transfer caused by diffusion does not normally exceed 1/5th to 1/10th of  $q_s$ .

We will assess the applicability of the above formulae for calculating the coefficient of thermal conductivity of the snow cover, without taking into consideration the temperature dependence (Abel's, Proskuryakov, Iosida, Iansson). Plotted on the broken line in Figure 1 are the two extreme curves characterizing at a definite density the lowest and the highest values of the coefficient of thermal conductivity of the snow cover (corresponding to the conductive and effective thermal conductivity at a temperature of about  $-1.2^{\circ}\text{C}$ ). The formulae of Kondrat'eva, Iosida and Sulakvelidze fall outside the range of possible variations of  $\lambda$  at any temperature. The most acceptable formulae are those of Proskuryakov, Iansson and Piotrovich, and also Porkhaev's calculated data, since they lie wholly within the range of possible variations of  $\lambda$ .

Figure 1

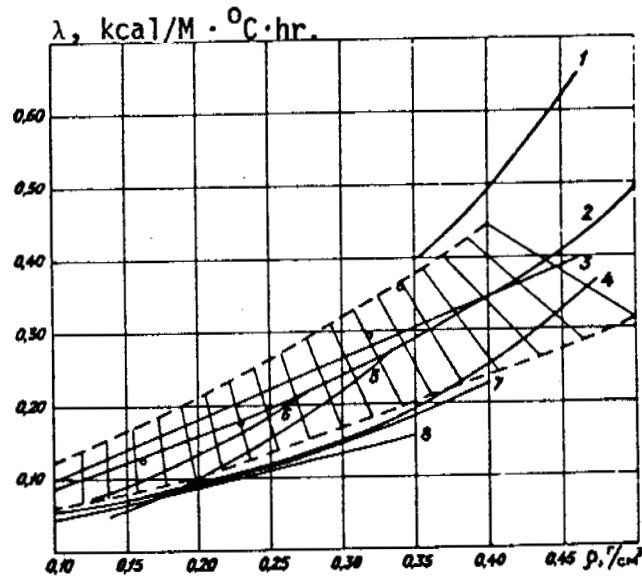

Comparison of formulae for calculating the coefficient of thermal conductivity of the snow cover  $\lambda$  as a function of the density  $\rho$ .

- 1 - after Kondrat'eva, 2 - Iansson, 3 - Proskuryakov, 4 - D'yakova and Serova, 5 - Abel's, 6 - Piotrovich, 7 - Iosida, 8 - Sulakvelidze, 9 - Porkhaev's calculated data.

The hatched area indicates the range of possible variations of  $\lambda$  (according to observations at Yakutsk and Igarka).

Now that we have a better understanding of the physics of the heat exchange processes in the snow cover, we will make a quantitative estimate of



the intensity of the heat exchange between the ground and the atmosphere both seasonally and as an annual total for what might be called standard natural terrain types. They are taken to be open areas of terrain with a continuous snow cover and we shall provisionally refer to them as "meadows". They are the most fully studied with respect to the surface heat exchange, since it is here that the network of hydrometeorological stations is situated. Presented in Table I are the averaged values of all of the components of the heat exchange between the ground and the atmosphere both for a period with an above-freezing  $t_s$  and a below-freezing  $t_w$  air temperature and also for the year  $t_{yr}$ .  $Q_s$  and  $S$  are the total and reflected radiation,  $I_{eff}$  is the effective surface radiation,  $R$  is the radiation balance,  $P$  is the turbulent heat exchange,  $LE$  are the expenditures of heat on evaporation ( $E$  is the evaporation,  $L = 600$  cal/yr), and  $B$  is the heat flux in the ground. In Table I the observation sites are arranged in increasing order of latitude (Vorkuta and Igarka are situated at approximately the same latitude). The observations at Vorkuta are characterized by disturbed rather than natural conditions of heat exchange, as here the station was situated at the boundary of the town, where the influence of technogenic factors is considerable (darkening of the surface by coal dust, etc.). All the remaining stations were situated outside the built-up area.

In summer, the albedo  $A$  of "meadows" is comparatively stable. In high and middle latitudes its value is usually between 16 and 25%. Shaded ground with a sparse herbaceous cover and also flooded areas are characterized by lower albedo values, while some types of light herbaceous covers containing pockets of cotton grass have higher values. No zonation is observed with respect to the distribution of the albedo for the U.S.S.R. as a whole during the warm season. On the average for the year the value of  $A$ , ranging from 30 to 57% increases with latitude. This is due to the fact that the ground remains snow covered for a longer period of time in high latitudes - the snow cover being characterized by a higher reflectivity - than is the case with herbaceous associations and soil.

The effective radiation of the natural surface of a "meadow" is 23 to 32% of the total radiation. During the warm season the highest value of the effective radiation  $I_{eff}$  (about  $20$  kcal/cm<sup>2</sup>) is observed at Yakutsk.

Table I

Components of the heat exchange between the ground and the atmosphere for "meadows".

Components	Kcal (season cm <sup>2</sup> )			% K	
	r <sub>s</sub>	r <sub>w</sub>	r <sub>year</sub>	r <sub>s</sub>	r <sub>y</sub>
Zagorsk (1957-1959)					
Q <sub>s</sub>	63.7	16.5	80.2	100.0	100.0
S	14.5	11.0	25.5	22.8	31.7
I <sub>eff</sub>	16.2	6.9	23.1	25.4	28.8
R	33.0	- 1.4	31.6	51.8	39.5
P	6.1	- 1.6	4.5	9.6	5.6
LE	25.0	1.3	26.3	39.2	32.7
B	1.3	- 1.1	0.2	2.0	0.2
Yakutsk (1970-1973)					
Q <sub>s</sub>	62.4	27.0	89.3	100.0	100.0
S	11.8	18.1	29.9	18.9	33.5
I <sub>eff</sub>	19.9	9.0	28.9	31.9	32.4
R	30.7	- 0.1	30.6	49.2	34.1
P	19.1	0.4	19.6	30.8	21.9
LE	9.3	1.0	10.3	14.9	11.5
B	2.1	- 2.0	0.1	3.4	0.1
Igarka (1971-1974)					
Q <sub>s</sub>	44.2	32.5	76.7	100.0	100.0
S	10.1	21.1	31.2	22.9	40.7
I <sub>eff</sub>	13.0	7.8	20.8	29.4	27.2
R	21.1	3.6	24.7	47.8	32.2
P	7.3	3.0	10.3	16.5	13.4
LE	11.3	1.7	12.0	25.6	15.7
B	2.5	- 2.3	0.2	5.7	0.3
Vorkuta (1959-1961)					
Q <sub>s</sub>	38.2	26.2	64.4	100.0	100.0
S	6.1	13.3	19.4	16.0	30.2
I <sub>eff</sub>	9.5	10.9	20.4	24.7	31.6
R	22.6	2.0	24.6	59.3	38.2
P	9.8	2.6	12.4	25.7	19.3
LE	9.6	0.8	10.4	25.2	18.9
B	3.2	- 2.0	1.2	8.4	1.9

Table I (cont'd)

		Solenaya (1974-1975)			
$Q_s$	37.5	35.4	72.9	100.0	100.0
S	9.3	32.1	41.4	24.8	56.9
$I_{eff}$	8.7	7.9	16.6	23.2	22.8
R	19.5	- 4.7	14.8	52.0	20.3
P	9.9	-	-	29.9	-
LE	6.6	-	-	17.6	-
B	1.7	- 1.6	0.1	4.5	0.1

Note: The character of the vegetative and mineral cover at the observation sites was as follows: Zagorsk - clover and herbage, sandy silt; Igarka - reed grass (Calamagrostis), very fine clayey silt; Vorkuta - hummocky tundra with dwarf Arctic birch, heavy clayey silt; Solenaya - moss and lichen hillocky tundra, clayey silt and sandy silt.

For the warm season the radiation balance R of the natural surface of a "meadow" is about half of  $Q_s$  (49 to 52%). The ratio between the annual values of R and  $Q_s$  ranging from 20 to 40%, decreases as the latitude increases. The anomalously low albedo and the increased value of the R/ $Q_s$  for Vorkuta is to be attributed to the heavy pollution of the atmosphere with coal dust at the boundary of the town.

The results obtained confirm the existence of a well defined latitudinal zonation with respect to the territorial distribution of the radiant heat exchange characteristics, as revealed by calculations and data from weather stations (Atlas of the Heat Balance, 1963; Pivovarova, 1966). This zonation is due to the decrease in the influx of total radiation and the increase in the length of time that the ground remains snow covered as the latitude becomes greater.

The expenditures of heat on evaporation LE vary in relation to  $Q_s$  within wide limits: from 15 to 39% in summer and from 11 to 33% in winter. While no regular pattern is to be seen in the spring-summer variation in the percentage of radiation heat expended on evaporation there is a noticeable tendency for LE/R to increase towards autumn (Table II). The reason for this is that whereas in spring and summer a part of the radiation heat is taken up

by the ground, by September the ground is releasing heat, which provides additional energy resources for evaporation.

Table II

LE/R

Place	Month					
	IV	V	VI	VII	VIII	IX
Zagorsk	0.45	0.74	0.72	0.75	0.73	0.84
Yakutsa	0.36	0.30	0.29	0.19	0.40	0.46
Igarka	0.51	0.15	0.48	0.57	0.58	0.69
Vorkuta	-	0.14	0.38	0.40	0.43	0.69
Solenaya	-	-	-	0.45	0.44	0.49

Research at the A.I. Voeikov Main Geophysical Observatory (Budyko, 1956; Zubenok, 1966) has shown that the geographic distribution of surface evaporation is governed mainly by the following factors: the energy resources (radiation balance) and the moisture conditions of the ground. In middle latitudes and especially in southern latitudes, where the influx of radiation heat is considerable, evaporation is almost wholly determined by the moisture conditions. When the precipitation is sufficient, expenditures of heat on evaporation are the main outgoing component in the heat balance. In particular, in the western and central regions of the European part of the U.S.S.R. up to 60 to 80% of the radiation balance is expended on evaporation. As the latitude increases the radiation balance decreases, which gives rise to an overall trend towards a decrease in evaporation. In the tundra zone (Igarka, Solenaya, Vorkuta) it is not only the evaporation that decreases but also, despite the supersaturation of the ground, the LE/R ratio, which here amounts to 34 to 54%. This is due to the decrease in the air temperature and the ground surface temperature, which can be regarded as secondary energy indices in relation to R and to the low yield of water from the mossy and peaty covers that are widely prevalent here. Thus, during the entire summer the LE/R ratio reaches a maximum (60 to 80%) in the middle latitudes (45 to 55°N), becoming smaller towards the south because of the insufficiency of moisture and also towards the north due to the low yield of water from the

ground. This general pattern in the distribution of the LE/R ratio may be greatly distorted in some regions (for example, Yakutsk) on account of an absence of zonation associated with the high moisture content.

In summer the turbulent heat exchange ranges from 6 kcal/cm<sup>2</sup> (Zagorsk) to 19 kcal/cm<sup>2</sup> (Yakutsk) or, in relation to Q<sub>s</sub>, from 9 to 31%. The P/LE ratio (Bowen's ratio) is characterized by minimum values in middle latitudes and becomes greater towards the north and south. There is a relationship between Bowen's ratio and the total precipitation. As indicated by the data for Vorkuta and Igarka, where P/LE ~ 1, the total annual precipitation r = 450 to 480 mm is evidently critical for estimating the prevailing effect of currents of turbulent heat or expenditures of heat on evaporation. At Zagorsk (r = 644 mm) P/LE << 1, at Yakutsk (r = 202 mm) P/LE ~ 2.

At the sites of the recording stations the accumulation of heat by the ground B during the period with above freezing air temperatures ranged from 1.3 (Zagorsk) to 2.5 kcal/cm<sup>2</sup> (Igarka). During this period a characteristic property of the heat balance components of "meadow" terrain is a substantial increase in the ground heat flux in the permafrost region. Here, its value can be as high as 5 to 6% in relation to Q<sub>s</sub> and 10 to 15% in relation to R. In the permafrost region there is a sharp peak in the amount of heat accumulated by the ground and this coincides with the beginning of its thawing. During this period the heat flux in the ground can be as much as 1.4 to 1.6 kcal (month·cm<sup>2</sup>) in some years. An abrupt decrease in the accumulation of heat by the ground then occurs. In regions where there is no frozen ground a smoother variation in the value of B during the summer is noted (Zagorsk). The release of heat by the ground occurs unevenly with time. It is greatest at the beginning of the winter. During October and November the ground may expend more than 50 to 60% of all of the heat losses throughout the winter.

Of course, the mean long-term conditions are such that the heat flux in the ground approximately equals the expenditure. The remaining components of the heat balance (R, P, LE) are from half to one order less during the t<sub>w</sub> period than during the t<sub>s</sub> period; quantitatively speaking they are approximately equal (see Table I). During the coldest months of the

winter, effective radiation predominates over the influx of total radiation, the duration of this period increasing as the latitude becomes higher. The period with a negative radiation balance is even longer. Radiation cooling leads to an air temperature inversion above the snow cover. R. Geiger (1960) was evidently the first to notice this. As a result of the inversional temperature distribution the turbulent heat flux is directed towards the surface of the snow cover and partly compensates for the heat losses by radiation. For the greater part of the winter turbulent heat exchange is an incoming component and expenditures of heat on evaporation an outgoing component of the heat balance. Evaporation of the snow cover is normally slight in comparison with the total reserves of snow and it cannot be taken into account in hydrological calculations. At the Yakutsk recording station, however, it was as much as 8 to 26% of the snow reserves (according to data from a six-year period of observation).

Experimental data indicate that the thermal turnover in peatlands is smaller than in mineral terrain. In particular, at Igarka the decrease in the thermal turnover in peatlands as compared to clayey silts was 9%. The comparatively small decrease in the thermal turnover is due to the fact that steep temperature gradients, intensifying the accumulation of heat, form in it because the frost table is near the surface. P.F. Shvetsov (Principles of Geocryology, 1959) has proposed a more general theory that there is an increase in thermal turnover as the lithological composition of the ground changes from mossy peatlands to gravel and shingle. Under natural conditions, however, ground consisting of coarse-grained particles is usually less moist and is not necessarily characterized by larger thermal turnovers, as the latter are caused not only by periodic variations in ground temperature but also by expenditures of heat on phase transitions of ground moisture with freezing and thawing. In situ data indicate that the thermal turnover is greater in clayey silts than in sandy silts and sands. Thus, the dependence of thermal turnover on the lithological composition of the ground is highly complex.

The positive and negative items of the thermal turnover in the ground originate under conditions of asymmetry of its thermal properties in the frozen and thawed state. The observations at the permanent recording

installations showed that under natural conditions, as a result of marked fluctuations in moisture content, the coefficient of thermal conductivity of the active layer may vary more appreciably during the annual cycle than during the transition from the frozen to the thawed state (Pavlov, 1975). This strongly distorts the temperature shift  $\Delta t$  which V.A. Kudryavtsev (1958) has defined as the difference between the mean annual temperature at the base of the active layer and the temperature at the ground surface. Under natural conditions the value of  $\Delta t$ , even in clayey silt and especially in coarse-grained materials, frequently remains within the range of accuracy of its experimental determination. Specifically, according to the data from long-term investigations at the permanent installations, the value of  $\Delta t$  was: Zagorsk and Yakutsk  $+0.2^{\circ}\text{C}$ , Vorkuta  $-0.6^{\circ}\text{C}$  and Igarka  $-0.3^{\circ}\text{C}$ . In mossy-peaty earth materials, however, the change in the coefficient of thermal conductivity as a result of phase transitions of moisture is much greater than when there is a change in the moisture content. The temperature shift in them is accordingly clearly defined. Thus, at Solenaya station the value of  $\Delta t$  was  $-1.5^{\circ}\text{C}$ .

The studies resulted in the discovery of a new general rule, characterizing the regional pattern which is manifest in the effect of the snow cover on the heat exchange processes between the ground and the atmosphere. As a result of the marked decrease in the coefficient of thermal conductivity of the snow with a lowering of the temperature, the insulating role of the snow cover in regions with severe winters is more pronounced than in regions with mild winters.

In comparison with open areas, the conditions in Siberia are such that water bodies and forest comprise the more common types of terrain.

In some regions containing frozen ground, water bodies account for up to half of the total area. They are a unique landscape which exerts an influence on the natural processes and in particular, on the temperature and thickness of permafrost.

Few systematic observations of water bodies have been conducted and almost all of them fail to encompass the winter. To quote the widely

prevalent metaphoric term, the aqueous environment (like the forest cover) is a "trap" for radiation. A generalisation of the results of actinometric observations pertaining to the water bodies of the U.S.S.R. indicates that in summer the radiation balance of water bodies  $R_{\text{wat}}$  is 20 to 40% higher than the value for treeless land areas  $R_0$  and that in the autumn the opposite relationship is observed (Kirillova, 1970). The ratio between the summer totals of  $R_{\text{wat}}$  and  $R_0$  becomes greater on the whole towards the south. The reflectivity of water bodies tends to decrease and the radiation balance increases as the water body becomes deeper. Year round investigations of the thermal physics of water bodies were conducted by the author in a small lake in the vicinity of Zagorsk and in a deep thermokarst lake at Syrdakh. We will compare the data on the albedo of Lake Syrdakh and that of the shallow lakes of Central Yakutiya during the ice free season (Table III). The noticeable decrease in the albedo of Lake Syrdakh (by 4 to 7%) is both on account of the increase in depth (and consequently in the absorptive capacity) and the decrease in transparency of the water.

Table III

Albedo of the lakes of Central Yakutiya, %.

Lake	Years	Months				Mean
		VI	VII	VIII	IX	
Syrdakh	1974-1975	6	7	8	14	7
Tyungyulyu	1963	11	12	15	24	14
Kradenoe	1968	8	12	13	17	11
Prokhladnoe	1969	-	9	11	16	11

Note: The data on the albedo of Tyungyulyu, Kradenoe and Prokhladnoe lakes were derived by M.K. Gavrilova (1973).

The ratio between the albedo of the water body during the season with an exposed water surface  $A_{\text{wat}}$  and the albedo of the surrounding treeless areas of land  $A_0$  does not exceed 1/3 during the summer months (Figure 2). In winter the differences between  $A_{\text{wat}}$  and  $A_0$  are minor and the value of  $|R_{\text{wat}}| > |R_0|$ , since the temperature of the active surface is higher and the radiation is greater. Taking the total for the year,  $R_{\text{wat}} \sim (0.9 \text{ to } 1.1)R_0$ .



At approximately equal annual values of the radiation balances of the water body and the ground, the circulation of heat in the water body is 6 to 8 times greater, which leads to the formation of taliks beneath the water bodies in the permafrost region.

Figure 2

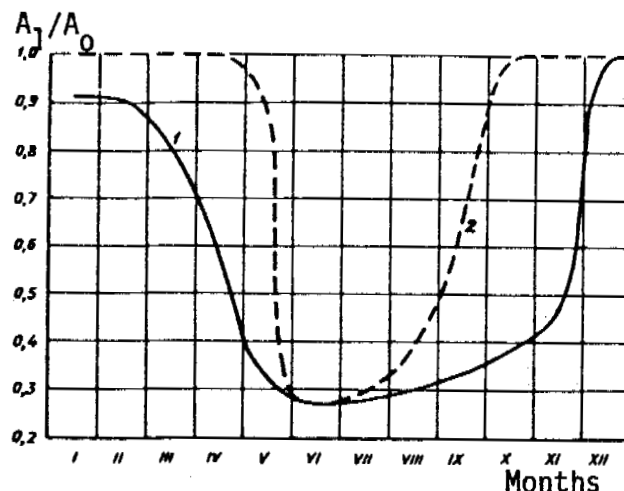

Annual variation in the ratio between the albedo of a lake  $A_1$  and of a treeless area  $A_0$

- 1 - a lake situated near Moscow;
- 2 - a lake at Syrdakh.

In the U.S.S.R. although forested areas occupy up to 35 to 40% of the overall area, in contrast to "meadows", their thermal physics have hardly been studied at all. The first complete group of long-term observations conducted in the permafrost region comprised pine forest at Yakutsk, birch forest at Igarka and larch forest at Syrdakh. Of special value are the investigations of the larch forest, which in many regions of Siberia occupies up to 80% of the forested area.

The reflectivity of forest cover over the year (with the exception of the late spring period, when the snow on the ground melts completely but still remains in the forest) is lower than in the treeless area. The albedo of the light coniferous forests of Siberia is 10 to 13% in summer, while that

of the larch forests is 14 to 19% (Table IV). In summer the ratio between the forest albedo  $A_f$  and the albedo of the open area is 0.5 to 0.8; in winter it does not exceed 0.6 (Figure 3).

Figure 3

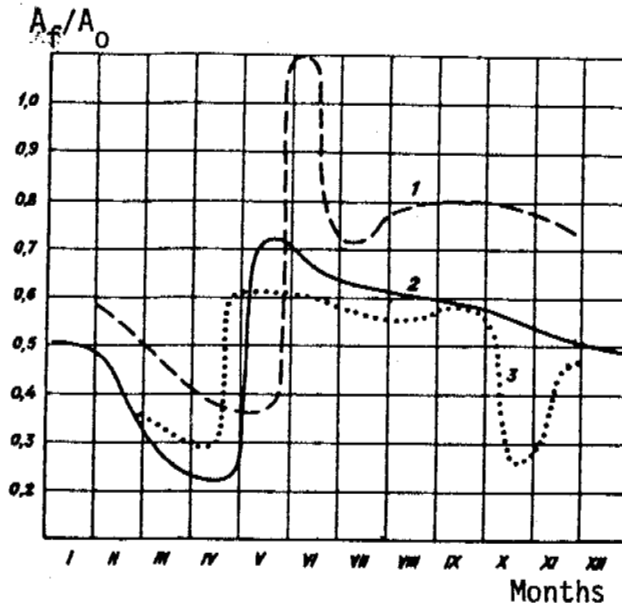

Relationship between the albedo of a forest  $A_f$  and the albedo of an open area  $A_o$ .

- 1 - birch forest (Igarka);
- 2 - pine forest (Yakutsk);
- 3 - larch forest (Syrdakh).

Table IV

Albedo and radiation balance of Siberian forest cover.

Season	Pine forest	Larch forest	Birch forest
Albedo, %			
$t_s$	10-12	10-13	14-19
$t_{yr}$	13-14	14-15	20-21
Radiation balance, kcal/cm <sup>2</sup>			
$t_s$	42	45	24
$t_{yr}$	51	50	34

The decrease in the reflectivity of forest cover as compared to "meadows" leads to a substantial increase in their radiation balance.

In order to estimate the radiation balance of a forest  $R_f$  as compared to an open area  $R_0$ , Yu. L. Rauner (1972) used observational data for close stands of larch and mixed forest at Zagorsk and Kursk during the warm season. The estimate was made from daily totals averaged over a period of several days. The dependence of  $R_f$  on  $R_0$  was obtained by the linear equation:

$$R_f = \bar{a}R_0 + \bar{b} \quad (3)$$

where

$$\bar{a} = 1.05, \bar{b} = 30 \text{ cal}/(\text{day} \cdot \text{cm}^2).$$

For coniferous forests (pine, spruce), Rauner gives other parameters of regression equation (3):  $\bar{a} = 1.1, \bar{b} = 35 \text{ cal} (\text{day} \cdot \text{cm}^2)$ .

The observations of the radiation regime of the pine and larch forests afford a basis for determining the closeness of the correlation between the daily totals of  $R_f$  and  $R_0$  under the conditions in Siberia (Figure 4). The correlation coefficient was 0.94. The parameters of equation (3) proved to be as follows for the light coniferous forests of Siberia:  $\bar{a} = 1.37; \bar{b} = 10 \text{ cal}/(\text{day} \cdot \text{cm}^2)$ .

The increase in the radiation balance of the forest during the winter  $R_3$  is 5 to 6 kcal/cm<sup>2</sup> for the larch and deciduous forests of Siberia and 7 to 8 kcal/cm<sup>2</sup> for the pine and spruce forests. Taking into consideration  $\Delta R_3$  the annual value of the radiation balance of forested landscapes can be calculated from the formula:

$$(R_f)_{\text{year}} = (\bar{a}R_0)_f + bt_f.$$

The results of the observations and also the published data (Rauner, 1972; Gavrilova, 1973 et al.) show that within a single region the difference between the seasonal and annual values of the albedo  $A$  and the

radiation balance  $R$  of the subjacent surface for various types of terrain can be greater than the difference between the same types in different regions. This enables us to use the values of  $A$  and  $R$  as leading factors when making an energy estimation of natural terrain types (Pavlov, 1975). Based on these indices the various types can be placed in a sufficiently well defined correspondence with "meadows". The relation between the remaining components of the heat balance ( $P$ ,  $LE$ ,  $B$ ) of the various types and the "meadow" is less definite. On the basis of the theories which have been considered, a general energy classification is compiled with respect to the most typical types of terrain. This classification is common to the forest-steppe, forest and forest-tundra zones of the U.S.S.R. (Table V).

Figure 4

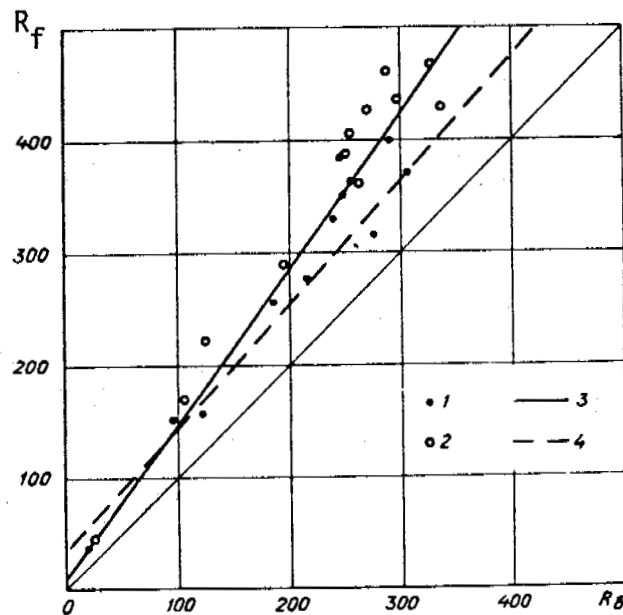

Correlation between the radiation balance of a forest  $R_f$  and the radiation balance of a treeless area  $R_0$  ( $\text{cal}/(\text{day} \cdot \text{cm}^2)$ )

- 1 - pine forest;
- 2 - larch forest;
- 3 and 4 - direct regressions from experimental data of the author and Yu. L. Rauner (1972) respectively.

Table V

Energy classification of natural terrain types.

Season	Pine and spruce forest	Larch forest	Birch and mixed forest	Water body	Icing area
Albedo (relative to the open area)					
$t_f$	0.55 - 0.6	0.55 - 0.65	0.6 - 0.85	0.45 - 0.55	1.0 - 2.0
$t_{yr}$	0.4 - 0.45	0.45 - 0.55	0.5 - 0.65	0.70 - 0.85	1.05 - 1.25
Radiation balance (relative to the open area)					
$t_f$	1.3 - 1.4	1.25 - 1.35	1.1 - 1.2	1.05 - 1.15	0.7 - 0.9
$t_{yr}$	1.6 - 1.7	1.4 - 1.5	1.3 - 1.4	0.85 - 1.15	0.5 - 0.7

REFERENCES

- Atlas of the Heat Balance of the Globe. 1963. Editor M.I. Budyko, Moscow, 69 pages.
- BUDYKO, M.I. 1956. The heat balance of the earth's surface. Leningrad, Gidrometeoizdat, 225 pages.
- GAVRILOVA, M.K. 1973. The climate of Central Yakutiya. Yakutsk, 119 pages
- GEIGER, R. 1960. The climate of the terrestrial layer of air. Moscow, Izd-vo IL, 486 pages.
- ZUBENOK, L.I. 1966. The role of evaporation in the heat balance of the land. In: Contemporary Problems in Climatology. Leningrad, Gidrometeoizdat, pp. 67-82.
- KIRILLOVA, T.V. 1970. The radiation regime of lakes and artificial reservoirs. Leningrad, Gidrometeoizdat, 253 pages.
- KUDRYAVTSEV, V.A. 1958. The effect of various covers on the depth of seasonal freezing and thawing. In: Aspects of the Physical Geography of Polar Countries, Izd-vo MGU, first edition, pp. 28-34.
- Principles of Geocryology, part 1, 1959. Moscow, Izd-vo AN SSSR, 431 pages.
- PAVLOV, A.V. 1965. The heat exchange between the atmosphere and freezing and thawing earth materials. Moscow, "Nauka", 254 pages.

PAVLOV, A.V. The heat exchange between the ground and the atmosphere in the northern and middle latitudes of the U.S.S.R. Yakutsk, 302 pages.

PIVOVAROVA, Z.I. 1966. A study of the solar radiation regime in the U.S.S.R. In: Contemporary Problems in Climatology. Leningrad, Gidrometeoizdat, pp. 41-56.

RAUNER, Yu. L. 1972. The heat balance of the vegetative cover. Leningrad, Gidrometeoizdat, 210 pages.



## GEOPHYSICAL ASPECTS OF THE DEVELOPMENT OF PERMAFROST

V.A. Kudryavtsev and V.G. Melamed

Faculty of Geology, Moscow State University, U.S.S.R.

Net radiation at the surface is the basis of the thermal state of the earth. It determines the climate of the atmosphere and lithosphere and, in particular, the temperature regime of the near surface layers of the lithosphere. As is known, the thermal radiation regime of the earth's surface depends on the solar constant, the latitude and characteristics of the geological and geographical environment of each given section of this surface. The first two factors are sufficiently stable and if they change at all, then only little and over long periods of time. At the same time, changes in the geological-geographical environment are both considerable and rapid, and this above all is the reason for all main changes in the thermal state of the earth, the climate of the atmosphere and temperature of the near surface layers of the lithosphere. Indeed, such phenomena as the atmospheric circulation, warm and cold sea currents, distribution of oceans and continents on the earth's surface, the structure of the surface of the continents (folded regions, lowlands), amount of ice in northern and southern seas, and mass exchange in the ground, and condensation of moisture in the atmosphere and lithosphere - all these phenomena determine the climate of the atmosphere and lithosphere, the thermal state of different regions, as well as the geographical and altitudinal zonality.

The existence of different cycles in weather conditions and climate is well known. There are short period fluctuations (lasting for hours, days and months), eleven-year cycles (which depend on solar activity), 1850-year cycles, etc. There are also long term fluctuations with periods of several hundred thousand and millions of years, which are related to the geological



periods of glaciation and the interglacial periods. Since the climate of the atmosphere and the lithosphere is due to one and the same cause, the net radiation at the earth's surface, the aforementioned fluctuations themselves are interrelated. It follows that one can talk about the aforementioned periodic changes in the temperature field of the earth and its dynamics.

The cryolithosphere exists in places where the soil temperature is  $0^{\circ}\text{C}$  or below as a result of specific characteristics of the heat and mass exchange on the surface of the earth. Depending on the duration of the existence of the aforementioned temperature field, there may be short term, daily, seasonal or perennial freezing of the near surface layers of the lithosphere lasting for hours, days, months, years and thousands of years respectively. The periodicity in the changes of the net radiation at the earth's surface determines the dynamics of the temperature field in the upper horizons, as well as the formation and the history of development of the cryolithosphere.

In the study of the dynamics and development of the cryolithosphere, it is essential to accept the view that the development of the temperature field of the earth and the cryolithosphere has been continuous and is the result of continuous changes in the net radiation at the surface of the earth. This makes it essential to reject the ideas of the steady state, quasi-steady state, etc., according to which the changes in the temperature field at depth constitute a disturbance of the steady state and terminate relatively quickly. In other words, because of continuous changes in the climate and the surface of the earth, a continuity of motion and development is an essential prerequisite for the temperature field in the near surface layers of the lithosphere. The state of rest is simply a special case of motion.

The theories in which the steady state plays a central role are based on field observations of the permafrost temperature, which show that at great depths this temperature remains stable for 20 or 30 years. That this approach is wrong becomes evident if we consider that although the amplitude of the surface temperature fluctuations attenuates rapidly with depth, there are, nevertheless, corresponding changes in the temperature field in layers of

considerable thickness. In spite of the fact that the absolute value of these fluctuations lies within the experimental error, it is these fluctuations which determine on the geological time scale the dynamics of development of permafrost.

The situation is similar with respect to the dynamics of the permafrost base. In the case where the formation and existence of permafrost is related to long period fluctuations extending over tens and hundreds of thousands of years, there will be changes in the thickness of permafrost of several millimeters or even fractions of a millimeter per year. This, of course, creates the impression that the temperature field within the permafrost is steady.

This often leads to the assumption that it is quite proper to apply steady state problems in general permafrost studies. However, the use of such problems results in utterly wrong conclusions on the patterns of formation of permafrost (in particular, the time of permafrost formation determined in this way is far too low).

In the well-known studies by D.V. Redozubov based on the ideas of the steady state, it is stated that permafrost up to 600 m in thickness can be formed in the course of 3000 years. At the same time, it follows from the solution of the Stefan problem without the initial conditions describing the dynamics of perennial freezing in the presence of periodic changes in the surface temperature (Table) that even in the case of long period temperature fluctuations of low amplitudes, the permafrost formed is now thick although its age is considerable.

It follows from the Table that the thickness of permafrost increases rapidly with the increase in the amplitude of fluctuations. On the other hand, the thickness of permafrost is greatly dependent on the geothermal gradient  $g$ . It increases as  $g$  decreases and reaches a maximum of  $g = 0$  (i.e., in places where the influx of subterranean heat is blocked by deep seated permafrost). The role of the geothermal gradient increases rapidly with an increase in the period of fluctuations of the surface temperature and becomes noticeable at periods of the order of several thousand years. The phase

transitions (i.e., the moisture content of earth materials) also influence the formation of permafrost but to a lesser extent (in terms of quantities) than the aforementioned factors.

In the presence of different fluctuations of the surface temperature, the temperature field of the near surface layers of the lithosphere and, in particular, formation and existence of permafrost are the result of the total effect of all those fluctuations. The temperature field in permafrost contains traces of periodic replacements of warming trends by cooling trends from different periods, which leads to a simultaneous occurrence of aggradation and degradation of permafrost at different depths. A good example of this is offered by geocryological conditions in the West Siberian Lowland, where deep-seated (70 - 200 m) relic permafrost is buried under unfrozen materials 30 to 100 m in thickness the upper part of which froze to a depth of 20 - 80 m at a later date (Zemtsov, 1962; Baulin et al., 1967; Sharbatyan, 1974; Gruzdov et al., 1972).

It is evident that the rhythmic nature of temperature conditions at the surface leads to periodic changes in the heat exchange in the permafrost. The warm and cold periods are related to degradation and aggradation respectively. Thus, in principle, there are no differences in this dynamic of the temperature field within and outside the permafrost region.

In spite of this, however, the literature contains references to the fact that cold is accumulated in the ground in the permafrost region, while outside this region the ground accumulates heat (positive and negative heat balance of the soil). This is obviously wrong, since otherwise the temperature in the permafrost region would drop to absolute zero, while outside this region heating would go on indefinitely and the earth materials would melt.

Hence, in any area and region, the dynamics of permafrost and the history of its formation and development are related to fluctuations of the heat exchange on the surface of the earth and the causes of these fluctuations. The study of the dynamics of development of permafrost requires a comprehensive analysis of the history of the surrounding

geological-geographical environment and of changes in the entire complex of geological and geographical factors affecting the heat exchange on the earth's surface and the formation of permafrost. Thus the history of formation of permafrost becomes a page in the history of development of the given region which is related to the palaeogeographical conditions in this region and on the earth as a whole, and in particular to the periods of glaciation and the interglacial periods. In this case the investigators should pay special attention to the effect of various geological and geographical factors on the heat exchange and the formation of permafrost. This makes it necessary to determine the specifics of the thermophysical patterns of formation of the thermal state of the upper layers of the Earth in different geological structures (mountain countries, lowlands and plains, uplands, plateaux, geosynclinal regions, denudation and sedimentation regions, and in different latitudinal and geobotanical zones).

TABLE

Thickness of permafrost forming for various amplitudes A and periods T of fluctuations in temperature at the surface when there is a geothermal gradient of 0.01 and 0.03 deg/m (in brackets) for the volumetric moisture content of earth materials of 25% (numerator) and 50% (denominator)\*

T, years	A, °C		
	2	5	8
10	2,37(2,33)	3,80(3,75)	4,84(4,78)
	1,68(1,66)	2,68(2,66)	3,41(3,39)
10 <sup>2</sup>	7,36(6,96)	11,8(11,4)	15,1(14,5)
	5,23(5,04)	8,40(8,16)	10,7(10,4)
10 <sup>3</sup>	21,9(18,6)	35,8(31,6)	45,9(41,1)
	15,9(14,2)	25,8(23,7)	33,0(30,6)
10 <sup>4</sup>	58,1(38,6)	99,0(72,4)	129(97,9)
	44,5(32,7)	74,4(59,1)	96,3(78,8)
10 <sup>5</sup>	119(56,0)	224(120)	304(174)
	101(52,8)	184(110)	245(155)

\* Depths of permafrost for the cycle obtained under the condition that the temperature at the surface is 0°C, the coefficient of thermal conductivity and the thermal capacity of the earth materials in frozen and thawed states 4.19 kJ/m/h°C and 2095 kJ/m<sup>3</sup>°C. respectively.

In the folded mountain regions, the most important factors are the altitudinal zonality, the geological and structural characteristics of rocks, the formation of terrain and of deluvial-proluvial deposits on the slopes, as well as the structure of the intermontane depressions. There are many types of thermal interaction of groundwater with permafrost due to the effect of closed artesian basins, different conditions of supply and discharge of groundwater in these basins, as well as of its chemical composition. On the plains of the Platform, it is the latitudinal zonality and the structural features of the cryogenic depositions and the Quaternary deposits extending over vast areas, which are the most clearly observable. Comparatively varied hydrogeological and geothermal conditions create a hydrogeothermic background against which the influence of the lithological composition and moisture regime of the earth materials is superimposed.

All of these factors, to one degree or another, leave their mark on the formation of the geocryological conditions of the region and determine the peculiarities of its composition, cryogenic texture, and likewise the temperature field, the thickness of the permafrost, and the processes and phenomena which occur within it. The dynamics and history of permafrost development in folded regions are characterized by their great complexity. The imposition of a series of fluctuations in surface temperature under these conditions is complicated by the dynamic nature of the geological-geographical conditions, landscape features, sedimentation and denudation, and neotectonic movements. On the platform and on the plains, the historical development and the dynamics of the permafrost are less complex, and periodic fluctuations in temperatures at the surface are clearly manifest.

All of the above offer convincing evidence of the necessity for a strong correlation between the geophysical, thermophysical and the geographical and geological aspects of the development of permafrost, i.e., the study of this phenomenon must be realized in a broad geophysical perspective. The thermophysical aspect must be examined for each given geological circumstance; this can be accomplished not only by the specification of extreme conditions and characteristics of the environment, but also by the selection of a general schema for the formulation and derivation of basic differential equations.

The dynamics of temperature fields of earth materials subjected to freezing and thawing within the framework of a continuum are best described by the Stefan problem. A characteristic feature of the above mentioned problem that has many applications in various fields of science and technology is the presence of internal, mobile boundaries separating the frozen and thawed zones (fronts), for which the law of dislocation is not known beforehand. Except for the steady state case, the associated specific non-linearity (in the sense of boundary conditions) of the Stefan problem excludes the possibility of using the principle of superimposition of solutions and greatly complicates research into patterns of occurrence under natural conditions.

In accordance with the aforementioned, which are typical of the freezing and thawing of the materials, there is their simultaneous occurrence at different depths during the periodic formation and disappearance of frozen and thawed layers (due to seasonal and perennial fluctuations in the climate); this leads to a multi-fronted Stefan problem with a variable number of fronts. In this case, as well the near eutectoid phase transitions of free and gravitational moisture, the conversion of bound pore moisture occurring in the diapazone at subzero temperatures is of substantial importance. Moreover, during freezing in damp, fine-grained materials, mass exchange (migration of moisture) leading to the formation of cryogenic textures and heaving plays an important role. No less significant is the mass exchange in coarse-grained materials during filtration and infiltration. Finally, the study of patterns of formation of geothermal fields is also complicated by the dependence of the thermophysical properties and permeability of materials on the composition and texture of the substance: factors which undergo change during freezing and thawing.

All of the aforementioned led to the fact that during calculations on freezing and thawing, the approximated results of the Stefan type of problem in very simple formulations were well developed. (Leibenson, 1931; Krylov, 1934, 1940; Charnyi, 1948, Lyk'yanov, Golovko, 1957; Porkhaev, 1970; Fel'dman, 1963 and others). Of great importance at the present time are the well known formulae and "express methods" for field calculations (Kudryavtsev et al., 1974). These allow quantitative research to be carried out on the freezing and thawing processes in earth materials during the periodic

establishment of regimes (Stefan problem without the initial conditions) with respect to individual geological-geophysical factors.

Despite the considerable success attained with the help of the given approach for solving a wide range of problems on geocryological forecasting and the rational use and protection of the environment, satisfactory answers need to be found to a whole series of important quantitative patterns of formation and development of permafrost.

Substantial success in mathematical research on the Stefan problem has only been attained recently. As a result, and also due to the rapid development of computers in recent years, a whole series of mathematically based algorithms of the solution of the Stefan problem have been proposed and are being used more and more (Melamed, 1958; Vasil'ev, Uspenskii, 1953; Samarskii, Moiseenko, 1965; Budak et al., 1965, 1967). Of great importance are self modelling solutions to the Stefan problem for general equations and also systems of quasilinear equations (Melamed, 1969), which allow not only research on the analytical and physical features of a given process, but also evaluation of the role of its numerous parameters. All of this opens wide perspectives for mathematical simulation of given geological processes on digital computers and for associated questions based on solution of the Stefan problem. A similar approach, when there is a strong correlation between the formulation of the problem and the geographical and geological conditions, gives the possibility of researching both general and individual patterns of the complex geological phenomena and for them to be characterized quantitatively.

The most developed are the various methods for solving the one dimensional Stefan problem for linear parabolic equations; a problem which describes the phase transitions of moisture that are similar to eutectoid transitions. As was shown in the work of Chudovskii (1954, 1976), Martynov (1959), Ivanov, (1970) and others, the given formulation is a sufficiently complete mathematical model of the freezing and thawing processes occurring in natural conditions in various types of coarse-grained materials (bedrock and semi-bedrock, shingles and gravels with sand and debris, sandy loam fillers, sands, etc.). One of the most effective algorithms for solving the given

multi-fronted Stefan problem is the method of reducing the Stefan problem to a system of ordinary differential equations (Melamed, 1958). Unlike the different algorithm, the proposed method not only allows a solution to the problem to be found when there is a change in the number of fronts as a result of the formation or disappearance of zones, but also, with given accuracy, determines the dynamics of heat flow in time for any section. This allows the possibility of using the algorithm developed in the study as an effective instrument for solving various problems in geothermal and permafrost forecasting, when there are occurrences of eutectoid phase transitions in the materials due to net radiation at the earth's surface. In particular, as a result of finding a periodically steady solution to the Stefan problem under examination (variable number of fronts during harmonic fluctuations of temperature at the surface), it was decided that, in time, the heat flow  $q$  in the layer of freezing (thawing) experiences interruptions of the first kind of discontinuity at the moment of flow-through by the front at the depth being investigated. The size of the interruption  $q$  and likewise the inflow value  $Q^+$  and the outflow value of  $Q^-$  of the constituent heat exchanges during the cycle decrease with depth. When this occurs, the heat exchanges are sharply reduced as they pass through the base of the layer of freezing (thawing).

With the help of the proposed algorithm, the feasibility of determining the inflow and outflow components of heat exchanges in materials during the cycle has made it possible to find annual fluctuations of "temperature shift" that are characteristic of the layer and which, for that cycle, link the mean temperature at the surface with that of the layer of freezing (thawing). Results derived by this method of investigation of temperature shift were used by V.A. Kudryavtsev (1958) to obtain the well known approximation formula.

The efficiency of this method for solving the Stefan problem with a variable number of fronts, has allowed research to be conducted into the near surface layer of the earth; a field that is forming as a result of superimposition of fluctuations in climate during various periods. All of this opens wide possibilities for research into the cardinal question of general permafrost studies: the creation of a retrospective model of the historical development of permafrost.



In slightly moist, fine-grained materials, where phase transitions of non-freezing water are very important in the freezing and thawing processes, the dynamics of the temperature field are described by a Stefan type problem for a quasilinear parabolic equation. At the present time, there are a number of suggested methods for the solution when there are weak restrictions on the data, as is the usual case (Melamed, 1976). Comparison of serial calculations of the given problem (for actual materials with various types of ice formation in the spectrum of subzero temperatures) with the corresponding solutions of the Stefan problem for eutectoid transitions examined above shows that during thawing, calculation of phase transitions of non-freezing moisture (all conditions being equal) leads to a substantial reduction in the depth of thawing and to a sharp rise in the temperature of the permafrost (observable even in fine-grained dust-particled sand). During freezing, the above effect is considerably weaker and should, in practice, be considered only in fine-grained materials when there is natural moisture imperceptibly exceeding the maximal molecular moisture content.

In very moist fine-grained materials (where the freezing processes are closely associated with the migration of moisture that leads to the formation of various cryogenic structures and heaving), the dynamics of the temperature field (with a few approximations basically associated with disregard for the questions of thermorheology) are best described by the type of Stefan problem for a system of quasilinear equations (Melamed, 1966, 1969; Takagi, 1970). In this case, the heat- and moisture exchange characteristics of materials (in particular the coefficients of heat- and potential diffusivity) depend substantially on the total resulting moisture. As mathematical research has shown, the given problem fully describes a number of important characteristics of the phenomenon being simulated that are shown from experiments and field observations.

At the present time, the algorithms proposed are for a solution of the problem when there are weak restrictions on input, for both arbitrary extreme conditions and self modelling circumstances. Comparison of results of mathematical and laboratory simulation of the freezing process in kaolin clay showed that the solution to the problem of freezing, when there is migration of moisture in all problems examined, is best described by heat and mass exchange in freezing, moist, fine-grained materials, with a very satisfactory degree of accuracy.

Calculations carried out for the above problem show that in contrast to conventional methods for calculating the depth of freezing (where the determining factor is the hourly frost degree index) in moist, fine-grained materials, it is necessary to give detailed consideration to the character of changes in the surface temperature during the winter months. In particular, determination of ice content throughout the section of frozen ground is closely connected with the non-monotonic nature of the surface temperature and is expressed in the succession of warming and cooling periods. This is most clearly manifested in the first half of the period of freezing. The resulting possibility of establishing a quantitative dependence of the cryogenic structure of permafrost on climatic conditions permits an indirect approach to the solution of the problem concerning the occurrence of paleotemperature conditions for formation of permafrost throughout the given section. Wide horizons are opened by the solution to this problem when: calculations are made of ice accumulation and associated heaving in various regimes of suprapermafrost water.

The self modelling solution to the problem of freezing when there is moisture migration allowed a number of important general characteristics of this process to be revealed and clarified. Related to it, for example, is research into the dependence of the moisture at the heave threshold on extreme conditions, primarily the temperature of freezing; this is widely applicable in permafrost engineering studies for estimating the susceptibility to heave in earth materials. This was later used extensively in the working out of new methods for calculating standard depths for laying foundations (Kudryavtsev, 1971). Moreover, with the help of the solution obtained, it was possible not merely to elucidate the concept expressed by M.N. Gol'dshtein in 1948 concerning optimal conditions for segregated ice formation, but also to solve the question quantitatively. In particular, calculations carried out for a number of actual fine-grained materials with physical properties substantially different from those of water, showed a non-linear dependence of the optimum temperature of segregated ice formation and heave on natural moisture; this increases strongly with the growth of the latter. In the same way, research into general patterns of maximum excess ice formation, conducted on the basis of the self-modelling solution to the problem of the Stefan type for a system of quasilinear parabolic equations, opens up the possibility of studying the

historical development of fine-grained permafrost and for the development of ways of controlling their cryogenic structure.

Of considerable interest are the recently obtained solutions to various problems of the Stefan type, which describe the processes of freezing and thawing during changes in the surface level according to the given law. The greatest complexity in this case calls for research into the temperature dynamics of the constituent systems when there is interaction of the rock matrix with the layer forming on its surface. An important feature of the above class of "contact" problems of the Stefan type is the fact that the number of fronts of freezing and thawing in the given problem was hitherto unknown. The solution to a wide range of problems of this type in the self modelling formulation not only allowed research into those general quantitative patterns of development of the freezing and thawing processes in the systems under investigation, but also into questions concerning control of these processes during various types of excavations (preparation of ground in open pit mines and placer areas, rubble mounds during construction of embankments and earth dams, etc.), optimization of snow accumulation, etc. Solution of Stefan type problems in accordance with the given law, when there is mobility of the surface, also allows the possibility of indirectly calculating the temperature field of the near surface layers, of the lithosphere caused by sharp changes in climatic conditions, transgressions and regressions due to sedimentation and denudation. Thus, the use of the methods examined above for solving one dimensional Stefan problems allows quantitative research to be carried out on a number of important general patterns of permafrost development in different types of earth materials, depending on a whole complex of geological and topographical conditions. The solution of the given problem is also of great importance for the creation and evaluation of "express" calculation methods widely used in permafrost studies. Finally, solution of the one dimensional problems of the Stefan type plays a very important role in perfecting methods of geocryological forecasting and environmental protection and, in particular, in the working out of scientifically based implementation of complex permafrost, permafrost-engineering-geological and hydrogeological surveys. In the Soviet Union, where permafrost-hydrogeological forecasting is very widely developed, the above research methods for permafrost processes based on the Stefan problem have been successfully employed for many years in the solving of

important national economic problems arising from industrial development of the vast territories of the North and Northeast U.S.S.R. All of this is convincing confirmation of the correctness and expediency of the broad geophysical approach to research into the permafrost processes and phenomena examined above.

A combination of the traditional determined systems based on the solution of the Stefan problem (examined above) and statistical systems has wide perspectives for solving the problems of geocryological forecasting in vast regions. Use of the latter (in particular with input of data by the Monte Carlo method, A.S. Tytkovich) permit the determination of the limits of fluctuations in the temperature regime of materials in the territory under examination, with regard to the influence of various local factors (facies; consistency of materials both by depth and areally; changeability of snow and vegetation cover areally and temporally; fluctuations from year to year in climatic conditions, etc.).

As well as the intense implementation of the solutions that are being examined (solutions to the various one dimensional Stefan problems), when studying individual problems of permafrost studies, solutions to multi-dimensional Stefan problems on digital computers are also employed. In this case, it is usual for the so-called integral-interpolation (equilibrium) methods associated with finite elements to be used. Apart from the extreme awkwardness of such solutions, their use to date in permafrost forecasting has been restricted by the absence of a demonstration of the existence of a classic solution to even the simplest multi-dimensional Stefan problem. Consequently, use of the above mentioned algorithms demands extreme care.

Future development of quantitative questions in permafrost studies is primarily associated with the complex study of the mechanics of various processes of heat and mass exchange occurring in the earth materials. Among these should be noted such important problems as the interaction of permafrost with the supra- and subpermafrost water, the thawing of materials with regard to infiltration and settlement, migration in permafrost, etc.

Mathematical computer simulation of the phenomena under investigation plays an enormous role in the solving of given problems. The

most important problem, along with the demonstration of the existence of a classic solution, is the working out mathematically of fundamental, efficient algorithms for the solution of multi-dimensional problems of the Stefan type. Future perfection of analog computers of a type such as the hydraulic integrator system of V.S. Luk'yanov, which played such a large role in the development of the mathematical model of permafrost processes and phenomena, is extremely important.

All of the above characterize to a sufficient degree the current state of the problem of the geophysical foundations of permafrost studies that explain the role of heat and mass exchange in the formation and development of seasonally and perennially frozen materials, their connection with the net radiation at the surface, with internal heat sources and with peculiarities of the formation of the geological environment and the physical geography. Research into these questions will, in the final analysis, allow an approach to the creation of theoretical bases for permafrost studies in the broad sense of the word.

Obviously the problem must be solved in stages. Thus, at the present time, work must be done on the following main problems:

1. The establishing of a quantitative link between the net radiation at the Earth's surface and patterns of formation of seasonally and perennially frozen materials;
2. clarification of quantitative estimates of the influence of geological and geographical environmental factors on the development of the permafrost region;
3. Quantitative research into heat and mass exchange in earth materials during freezing and thawing;
4. determination of the dynamics of the temperature field of seasonally and perennially frozen materials due to the historical development of the region being researched;

5. determination of the geophysical (heat and mass exchange) conditions of formation and development of cryogenic structures;
6. the working out of the geophysical bases of the connection between the development of the permafrost region and paleogeographical conditions;
7. development of a theory on evolution of the permafrost region as a global phenomenon due to latitudinal zonality, altitude and special structural features of our planet and the geological history of the earth;
8. the working out of the principles of geocryological forecasting, and applications of control of the permafrost processes caused by changes in the natural historical conditions and by anthropogenic action.

#### REFERENCES

- BAULIN, V.V., BELOPUKHOVA, E.B., DUBIKOV, G.I. and SHMELEV, L.M. Geokriologicheskie usloviya Zapadno-Sibirskoi nizmennosti. (Geocryological conditions of the West Siberian Plain). M., Nauka, 1967.
- BACHELIS, R.D. and MELAMED, V.G. Reshenie kvasilineinoi zadachi tipa Stefana metodom pryamykh. (Solving the quasilinear Stefan type problem by the straight line method). VINITI, No. 3941-72 Dep., pp. 1-17, 1972.
- BUDAK, B.M., VASIL'EV, F.P. and USPENSKII, A.B. Raznostnye metody resheniya nekotorykh kraevykh zadach tipa Stefana. (Differential methods of solving some marginal Stefan type problems). In the book: Chislennye metody v gazovoi dinamike. (Numerical methods in gas dynamics).. No. 4., Izd-vo MGU. pp. 139-183, 1965.
- BUDAK, B.M., VASIL'EV, F.P. and EGOROVA, A.T. Raznostnyi metod s lovlei fronta v uzel setki dlya zadachi Stefana s nemonotonno dvizhuschchimsya frontom. (Differential method with the capture of the front into the node of the network for a Stefan problem with a non-monotonically mobile front). In. the book: Vychislitel'nye. (Computing methods and programming). No. VI. Izd-vo MGU, pp. 231-141, 1967.

- VASIL'EV, F.P. and USPENSKII, A.B. Raznostnyi metod resheniya dvykhfaznoi zadachi Stefana. (Differential method for solving the two-phase Stefan problem). Vychislitel'naya matematika i matematich. fizika., Vol. 3, No. 5, pp. 874-886, 1963.
- GOL'DSHTEIN, M.N. Deformatsiya zemlyanogo polotna i osnovanii sooruzhenii pri promerzanii i ottaivanii. (Deformation of road beds and foundations during freezing and thawing). Trudy Vsesoyuz. In-ta zhel.-dor. transp., No. 16, Transzheldorizdat, p. 258, 1948.
- GRUZDOV, A.V., TROFIMOV, V.T. and FIL'KIN, N.A. Osnovnye zakonomernosti rasprostraneniya stroeniya tolshch i temperatur mnogoletnemerzlykh tolshch Tazovskogo poluostrova. (Basic distribution patterns of structure and temperatures of permafrost in the Taz Peninsula). In the book: Prirodnye usloviya Zapadnoi Sibiri. (Environmental conditions of Western Siberia)., No. 2, Izd-vo MGU, pp. 115-133, 1972.
- ZEMTSOV, A.A. Mnogoletnemerzlye porody v poime r. Enisei. (Permafrost in the floodplain of the Yenisei River). Trudy In-ta merzlotovedeniya im. Obrycheva, Vol. 19, Izd-vo AN SSSR, M., pp. 72-74, 1962.
- IVANOV, N.S. Teplo- i massoperenos v merzlykh gornykh porodakh. (Heat and mass transfer in frozen earth materials). M., Nauka, p. 239, 1970.
- KRYLOV, M.M. K teplotekhnicheskomu analizu promerzaniya grunta. (Thermotechnical analysis of the freezing of earth materials). Vestn. inzhenerov i tekhnikov, No. 1, pp. 466-467, 1934.
- KRYLOV, M.M. Raschety promerzaniya i ottaivaniya. (Calculations of freezing and thawing). Vestn. melioratsii i gidrotekhniki, No. 1, pp. 58-63, 1940.
- KUDRYAVTSEV, V.A. Novaya metodika opredeleniya glubiny sezonogo promerzaniya gruntov. (New methods for determining depths of seasonal freezing of earth materials). Osnovaniya, fundamenty i mekhanika gruntov. No. 6, pp. 35-36, 1971.
- KUDRYAVTSEV, V.A., GARAGULYA, L.S., KONDRAT'EVA, K.A. and MELAMED, V.G. Osnovy merzlotnogo prognoza pri inzhenerno-geologicheskikh issledovaniyakh. (Principles of permafrost forecasting in geological engineering research). Izd-vo MGU, p. 431, 1974.
- LUK'YANOV, V.S. and GOLOVKO, M.D. Raschet glubiny promerzaniya gruntov. (Calculation of depth of freezing of earth materials). M., Transzheldorizdat, p. 164, 1957.
- MARTYNOV, G.A. Teplo- i vlagoperedacha v promerzayushchikh i protai-vayushchikh gruntakh. (Heat and moisture transfer in freezing and thawing earth materials). In the book: Osnovy geokriologii (merzlotovedeniya), (Principles of Geocryology/Permafrost studies) Pt. 1, Ch. 6, M., Izd-vo AN SSSR, pp. 153-188, 1959.

- MELAMED, V.G. Svedenie zadachi Stefana k sisteme obyknovennykh differential'nykh uravnei. (Reducing Stefan problems to a system of ordinary differential equations). Izv. AN SSSR. Ser. geofiz. No. 7, pp. 848-869, 1958.
- MELAMED, V.G. O chislennom integrirovanii klassicheskoi zadachi Stefana pri nalichii fazovykh perekhodov v spektre temperatur. (Numerical integration of the classic Stefan problem in the presence of phase transitions in the temperature spectrum). Izv. AN SSSR, Ser. geofiz. No. 2, pp. 340-344, 1963.
- MELAMED, V.G. Matematicheskaya formulirovka zadachi promerznyiia vlaznykh gruntov s uchetom migratsii vlagi i usloviya obrazovaniya ledyanykh prosloev. (Mathematical formulation of the problem of freezing of earth materials with regard to migration of moisture and the condition of formation of ice layers). In the book: Merzlotnye issledovaniya (Permafrost Research). no. 6, Izd-vo MGU, pp. 28-38, 1966.
- MELAMED, V.G. Avtomodel'noe reshenie zadachi teplo- i vlagoobmena v promerzayushchikh tonkodispersnykh porodakh pri zadannom zakone izmeneniya urovnya poverkhnosti. (Self modelling solution to the problem of heat and moisture exchange in freezing, very fine-grained earth materials for a given law of change in surface level). In the book: Merzlotnoe issledovanie (Permafrost Research). No. 15, Izd-vo MGU, pp. 27-37, 1967.
- PORKHAEV, G.B. Teplovoe vzaimodeistvie zdaniy i sooruzheniy s vechnomerzlyimi gruntami. (Thermal interaction of buildings and structures with perennially frozen ground). M., Nauka, p. 206, 1970.
- SAMARSKII, A.A. and MOISEENKO, V.D. Ekonomicheskaya schema skvoznogo scheta dlya mnogomernoii zadachi Stefana. (Effective schema for complete calculation for the multiple Stefan problem). Vych slitel'naya matematika i matematich. fizika. Vol. 5, No. 5, pp. 816-827, 1965.
- FEL'DMAN, G.M. Metody rascheta temperaturnogo rezhima merzlykh gruntov. (Methods for calculating the temperature regime of frozen earth materials). M., Nauka, p. 254, 1973.
- CHARNYI, I.A. O prodvizhenii granitsy izmeneniya agregatnogo sostoyaniya pri okhlazhdenii ili nagrevanii tel. (Advance of the boundary of the state of aggregation during cooling or warming of a body). Izv. tekhn. nauk., No. 2, pp. 187-202, 1948.
- CHUDNOVSKII, A.F. Teploobmen v dispersnykh sredakh. (Heat exchange in very fine-grained materials). Gostekhizdat, M., p. 444, 1954.
- CHUDNOVSKII, A.F. Teplofizika poch. (Thermophysics of soils). M., Nauka, p. 351, 1976.
- SHARBATYAN, A.A. Ekstremal'nye otsenki v geotermii i geokriologii. (Extreme estimates in geothermy and geocryology). M., Nauka, p. 122, 1974.
- TAKAGI, S. An analysis of ice lens formation. (Water Resour. Res. Vol. 6, No. 5.





AN NMR STUDY OF THE PHASE TRANSITION OF WATER  
IN MODELS AND IN FROZEN CLAYS

V.I. Kvlividze, V.F. Kiselev, A.V. Krasnushkin, A.B. Kurzaev and L.A. Ushakova  
Moscow State University, Department of Physics, U.S.S.R.

Studies of the process occurring at the water-solid interface are of great interest to geocryology and many other areas of science and technology. Numerous studies on the properties of water in dispersed systems unequivocally evidence stable co-existence of ice and mobile water phase within a large interval of negative temperatures. In the literature there are, however, contradictory views regarding the nature and the mechanisms of structural changes in the surface water phase, as well as the properties of that phase.

The use of nuclear magnetic resonance (NMR) techniques opened up new possibilities for the studies of phase transitions. The effective use of NMR in studies of the solid-liquid phase transition is due to the width of the NMR spectrum decreasing by several orders in the course of the transition (Abragam, 1963). The latter circumstance permits us to use the NMR spectra for determining the phase composition of the sample. In this paper we examine the results obtained from a NMR study of the ice-water phase transition in models (both inorganic and biological) and clays with the purpose of elucidating the nature of the drop in the melting point of ice in dispersed systems, in frozen earth materials in particular.

Objectives of the study

In order to solve the problem specified, we studied the state of water in porous, as well as non-porous adsorbents at the interface with

hydrophilic and hydrophobic solids, as well as at the ice-vapour interface. The following systems were selected as objects of study: dispersed ice; water dispersions of polyfluoroethylene, silica powder, montmorillonite and kaolinite; adsorption films on the surface of silica powder, silica gel and kaolinite, as well as protein solutions.

The properties of the samples were as follows. The specific surface of dispersed ice was  $S \sim 30 \text{ m}^2/\text{g}$ . The technique used for preparing ice samples, was described in detail in an earlier publication (Kvlivdze et al., 1974). Dispersion of polyfluoroethylene was prepared from spherical particles with an average diameter of  $35 \text{ nm}$ . The method used for preparing the dispersion of polyfluoroethylene was described by V.A. Pchelin (1970), specifications of the samples - by A.B. Kurzaev et al., (1973). The dispersion of silica powder consisted of particles averaging  $20 \text{ nm}$  in diameter, which corresponds to  $S \sim 140 \text{ m}^2/\text{g}$  of silica powder; the surface of the particles came to  $\sim 20^2 \text{ m}^2$  per 1 g of water (Kvlivdze et al., 1974). In preparing the dispersion of montmorillonite, we used Na - moulds of askanite gel ( $S \sim 600 \text{ m}^2/\text{g}$ ). The surface of the particles was  $\sim 30 \text{ m}^2$  per 1 g of water. Kaolinite dispersions were prepared from a sample of kaolinite clay ( $S \sim 25 \text{ m}^2/\text{g}$ ) in calcium moulds. In order to reduce the content of OH-groups, the mineral was partly deuterated. We studied samples with the water contents of 3.3 and 30 m mole per 1 g of dry clay. V.I. Kvlivdze et al., (1972) provided a detailed description of the Ca-kaolinite samples. The SKS\*-3 silica gel used is a uniformly coarsely porous adsorbent ( $S \sim 340 \text{ m}^2/\text{g}$ ; average diameter of the pores  $7 \text{ nm}$ ; moisture content of the sample 44 m mole  $\text{H}_2\text{O}/\text{g}$  silica gel (Kvlivdze and Kiselev, 1967)).

Apart from that, we investigated 2.5% protein solutions, i.e., albumen from human serum (Kurzaev et al., 1975).

In order to obtain NMR spectra, the samples were placed in glass ampoules and sealed. In the case of the samples containing adsorbed water the ampoules were filled with helium in order to improve the heat exchange during the freezing of the samples.

---

\* Transliteration. Brand name. (Translator).

Techniques used to obtain NMR spectra and in processing the results.

The main measurements of the NMR spectra were obtained in a broad-band autodyne spectrometer. The instrument records the derivative of the adsorption signal; the operating frequency of the spectrometer is 12.5 MHz. The measurements were taken in the 80 - 272 K temperature interval. The  $\Delta\nu$  width of the narrow bands was measured in high-resolution spectrometers.

The proton magnetic resonance spectra of the adsorbent-water systems commonly consisted of several signals belonging to the stationary  $H_2O$  molecules (the broad band), mobile  $H_2O$  molecules (the narrow band) and protons from the OH groups of the adsorbent, respectively. In order to obtain the spectrum of the water molecules as such, the band of the OH-groups must be deducted from the total signal. Failure to take into account the contribution of the OH-groups to the NMR signal recorded may lead to the erroneous conclusion that mobile water molecules exists even at the temperature of liquid nitrogen, as was done by Pearson and Derbyshire in their work (1974). If the spectrum is composed of several bands varying in width (Figure 1), the relative integrated intensity of each individual component makes it possible to calculate the fraction of the nuclei producing it.

Figure 1

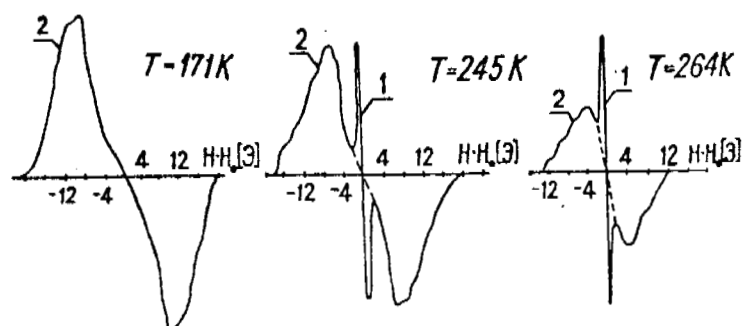

Derivative of the NMR adsorption signal of the Na-montmorillonite aqueous dispersion at different temperatures.

1 - the narrow component; 2 - the broad component.

In a broad-band spectrometer we commonly observe remodulation of the narrow component and, consequently, distortion of the shape of the line. Remodulation of the line introduces, however, no error into the determination of its integrated intensity, since the proportionality between the integrated intensity of the line and the amplitude of modulation persists even at greater magnitudes of modulation, when the shape of the line is distorted. This circumstance is of great importance in the case of the complex spectrum examined: relative integrated intensities of the components of the spectrum are independent of the amplitude of modulation. The fraction of mobile molecules can thus be determined from the spectrum recorded in the course of remodulation of the narrow line. The relative integrated intensity of the narrow line was calculated with the help of a computer by way of digital integration.

In taking temperature measurements of NMR spectra it is imperative to keep in mind the possibility of temperature hysteresis, i.e., the results of the measurements may be affected by the preceding temperature regime of the sample. In order to avoid ambiguous results, the temperature evolution of the spectra was always studied under standard conditions, where the sample was heated from 77 K to the temperature specified for the experiment.

### Results of the experiment

At  $T = 77$  K the NMR signal of water protons consists in all the entities under investigation only of the broad component produced by immobile frozen water molecules. The features characteristic of temperature changes in the spectra of all the systems studied are the appearance of a narrow component (the mobile phase of water) at temperatures below 273 K and the simultaneous presence of the narrow and broad components of the spectrum within a definite temperature interval. As an example we present in Figure 1 spectra of the water-Na-montmorillonite system at different temperatures. As may be seen from that diagram, the intensity of the narrow component increases with the rise in temperature, while that of the broad component decreases.

Figure 2

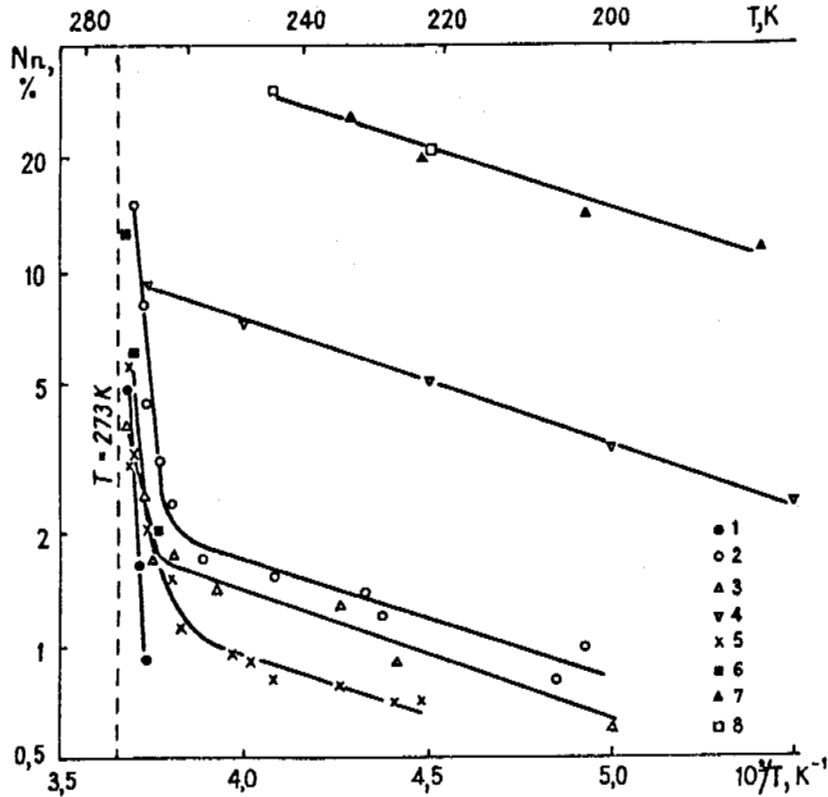

- 1) - the content of the mobile phase of water as a function of inversion temperature for dispersions of polyfluoroethylene;
- 2) - silica powder; 3) - Na-montmorillonite; 4) - Ca-kaolinite;
- 5) - 2.5% protein solution - serum albumen; 6) - dispersed ice;
- 7) - and samples with a film of water adsorbed on silica powder;
- 8) - and on Ca-kaolinite.

Figure 2 shows the relative content of mobile water molecules  $N_n$  as a function of inversion temperatures for different entities. The initial points in the low temperature region correspond to the narrow component recorded with confidence. If the only boundaries present in a heterogeneous system are ice-vapour or ice-hydrophobic material, the emergence of mobile water molecules is noted at temperatures above 250 K, i.e., 15 - 20 K below the melting point of ice under normal conditions. If the ice is in contact with hydrophilic materials, including protein macromolecules, then the mobility of molecules appears at temperatures of 170 - 190 K, i.e., 50 - 100 K below the melting point of ice.

In the  $T < 260$  K region (see Figure 2) the law governing changes in  $N_n$  is the same for all the hydrophilic materials. In the 180 - 260 K temperature region the dependence of the number of mobile molecules is subject to the equation

$$N_n = N_0 \exp \left( -\frac{E_1}{RT} \right), \quad (1)$$

where  $E$  is the energy causing the change of molecules to the mobile state, and  $R$  is the gas constant. For this temperature interval  $E_1 \sim 6.7 - 7.5$  Mjoules/kmole, i.e., differs but little from the heat of fusion of ice (6.1 Mjoules/kmole). The sharp increase in  $N_n$  at  $T > 260$  K corresponds to the beginning of melting of the main bulk of ice.

It is interesting to juxtapose the results obtained for the adsorbed water and water dispersion at the same adsorbent. We can make this comparison for silica powder and kaolinite. As may be seen from Figure 2, the gradient of the straight lines  $\log N_n (1/T)$  is the same for water dispersions and adsorption films. This circumstance suggests that the mechanism governing the appearance of mobile water molecules in adsorption films, where the water-vapour interface exists alongside the solid-water interface, is the same as that in water dispersion systems, where there is no such interface. It should be noted that the absolute quantity of mobile water per  $1 \text{ m}^2$  of adsorbent's surface coincides at the given temperature in the adsorption film and frozen water dispersion within the margin of errors of the experiment.

In addition to the temperature dependence of the concentration of mobile molecules, we examined variations in the width of the line of the narrow component. The data on the dispersion of silica powder and kaolinite are shown in Figure 3. In the  $T < 260$  K region the width of the narrow NMR line  $\Delta\nu$  for all the hydrophilic systems is subject to a dependence of the following aspect:

$$\Delta\nu = (\Delta\nu)_0 \exp \frac{E_2}{RT}, \quad (2)$$

where  $E_2$  is the energy initiating molecular motion. The magnitude of  $E_2$  is 18 and 19 Mjoules/kmole for silica powder and kaolinite dispersions, respectively, whereas  $E_1$  determined from equation (1) does not exceed 7.5 Mjoules/kmole.

There are several hypotheses regarding the nature of the mobile water molecules recorded: a) diffusion of molecules over the surface without the formation of a new phase (Resing, 1967, 1972); b) diffusion of defects inside the ice crystals; c) formation of the incipient liquid phase (liquid "embryos"), i.e., the beginning of melting of the ice. A discussion regarding the first hypothesis was published earlier (Kvlividze, 1971). As may be seen from that paper, this hypothesis cannot explain the total conjunction of experimental facts. The mechanism of the volume diffusion of defects also fails to correspond to the fact observed (Kvlividze et al., 1972):  $E_1$  (the energy initiating the formation of defects) in equation (1) should be greater than  $E_2$  (the energy initiating the motion) in equation (2), whereas it is obvious from the values of  $E_1$  and  $E_2$  presented above that we are dealing with the opposite ratio.

Figure 3

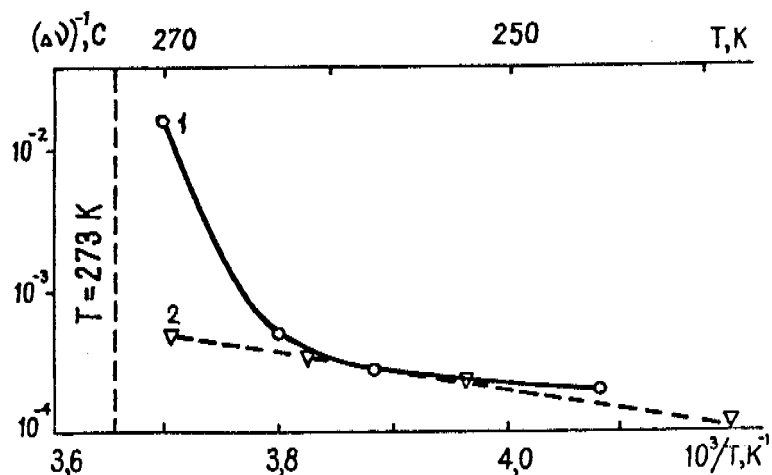

- 1) - temperature dependences of the width of the narrow line of the spectrum in aqueous dispersions of silica powder;
- 2) - and Ca-kaolinite.



The third mechanism, i.e., melting of the surface phase of ice, is the most probable one. This is supported first of all by the evidence from the studies into the thermal capacity of the adsorbent-water systems for non-porous (Plooster, Gitlin, 1971) and porous (Berezin et al., 1972) adsorbents. These studies have demonstrated the presence of a heat capacity anomaly related to the melting of ice in the adsorption space.

Measurements of the width of the narrow component's line may be used to obtain assessments of the correlation time which characterize the degree of mobility of the water molecules contribution to the narrow component of the NMR spectrum. For example, for the dispersion of polyfluoroethylene at  $T = 270$  K the time of correlation is  $r_c \leq 10^{-10}$  c; for dispersed ice it is  $r_c \leq 10^{-11}$  c at the same temperature (Kvlivdze et al., 1974). Let us mention for the sake of comparison that pure water has  $r_c \sim 10^{-12}$  c, and crystalline ice  $r_c \sim 10^{-4}$  c. Unfortunately we have been unable to obtain reliable assessments of  $r_c$  for frozen earth materials or for any other systems because the observable width of the proton resonance line is determined by paramagnetic impurities (Krasnushkin, Kvlivdze, 1971; Pfeifer, 1972, 1976) or other secondary factors rather than by the mobility of water molecules.

If we neglect to take into consideration the broadening of the lines on account of these factors, the values of correlation time obtained from calculations will be as much as several orders of the magnitudes too high. In reality, however, we can only obtain the maximum value of the correlation time (which is or the order of  $10^{-9}$  c)) for complex heterogeneous systems with paramagnetic admixtures.

In comparing the data for dispersions varying in concentration and for samples with adsorbed water, it has been established that the absolute quantity of mobile molecules at the given temperature and in the presence of adequate possibilities is not a function of the total water content in the system. It may therefore be assumed that the liquid phase forms at the phase interface rather than within the ice. It may thus be seen from the information presented above that mobile molecules represent rudiments ("embryos") of the liquid phase and appear at the ice-hydrophilic surface

interface at temperatures of 170 - 190 K, or at the ice-vapour or ice-hydrophobic surface interface at temperatures of 250 - 260 K (Kiselev et al., 1973).

The different character of the  $N_n$  (1/T) curves (see Figure 2) for hydrophobic polyfluoroethylene and dispersed ice particles on the one hand, and for hydrophilic systems on the other, evidences the importance of the active surface centres in the formation of the incipient mobile water phase. We assessed the quantity of mobile water molecules per active centre in different samples. In silica powder and Ca-kaolinite there are, for example,  $\sim 5$  and  $\sim 7$  mobile molecules, respectively, per active centre (OH-group) at  $T = 238$  K. We did not take into account in the calculations the most active primary adsorption centres, since their number is smaller by at least an order than that of the OH-groups (Kiselev, 1970; Sklyankin, Kireev, 1972).

Similar results were obtained from the studies of frozen protein solutions (Kurzaev et al., 1975). Curve 5 in Figure 2 suggests that the qualitative character of the  $N_n$  (1/T) change in this substance is the same as in inorganic materials. Polar aminoacid residues act as active centres in proteins (Gaurovits, 1967). It has been established that at 238 K the number of mobile water molecules per polar aminoacid residue comes to  $\sim 5$ , i.e., is close to the magnitudes obtained for inorganic materials. The mobile water phase in a biopolymer appears to have no specific characteristics different from those of inorganic systems.

The data obtained for Na-montmorillonite stand somewhat apart from this series. If exchange cations are to be regarded as active centres on the surface of montmorillonite, then there are  $\sim 20$  mobile water molecules per exchange cation at  $T = 238$  K. In our opinion the difference is due to the fact that exchange cations are not the only adsorption centres in montmorillonites (Mooney et al., 1952; Krasil'nikov, Skoblinskaya, 1972).

We now wish to examine another extreme case, i.e., the appearance of the mobile phase of water at the ice-hydrophobic surface interface of polyfluoroethylene. It has been established that the  $N_n$  (1/T) dependence for polyfluoroethylene practically coincides with the corresponding dependence

for polydispersed ice. Fletcher (1968) has demonstrated that the mobile water phase arises on the ice surface at negative temperatures. This circumstance was believed to be related to the disturbed structure of the region adjacent to the surface in ice crystallites. The fact that the  $N_n$  ( $1/T$ ) curves of ice and polyfluoroethylene are close suggests that the properties of the surface in pure ice are similar to those of the ice-polyfluoroethylene interface. A hydrophobic surface has virtually no effect on the formation of the mobile phase of water or on melting of the total mass of ice. The role of a hydrophobic material appears to be merely to form a surface similar with respect to its properties to the free surface of ice or water. The so-called hydrophobic interactions appear to be effected by the forces of the surface tension of that water surface.

Proceeding from the magnitudes of the solid-ice interface and from the relative content of mobile water molecules, we can assess approximately the thickness of the water film near the solid-ice interface (Figure 4). In these calculations we assumed the thickness of the water monolayer to be equal to  $0.3 \text{ nm}$  and the density of water outside the monolayer to be normal. As may be seen from Figure 4, all the hydrophilic solids are characterized by the appearance of a water film at temperature of  $170 - 190 \text{ K}$ . The thickness of the water films in the  $T \sim 260 \text{ K}$  region comes to  $0.8 - 2 \text{ nm}$ , i.e., is of the same order as the thickness of the films, where the mobility of water molecules altered at room temperature (Olejnik, White, 1972; Morariu, Mills, 1972). It may thus be seen from the studies on melting of ice in dispersed systems that the impact of a hydrophilic surface on the properties of adjacent water horizons is restricted to several molecule layers. None of these data corroborate the widespread hypothesis postulating the existence on the surface of thick films of water with anomalous properties (Schufle et al., 1976).

The data obtained from the experiments regarding temperature changes in the NMR spectra and calorimetric measurements, are presented above. These data suggest that a phase transition of the type of fusion actually takes place in the surface phase of water and is not merely an "apparent" effect inherent in the NMR method, as was assumed earlier (Resing, 1967, 1972; Pfeifer, 1972, 1976). Ice begins to melt at the phase interface.

Figure 4

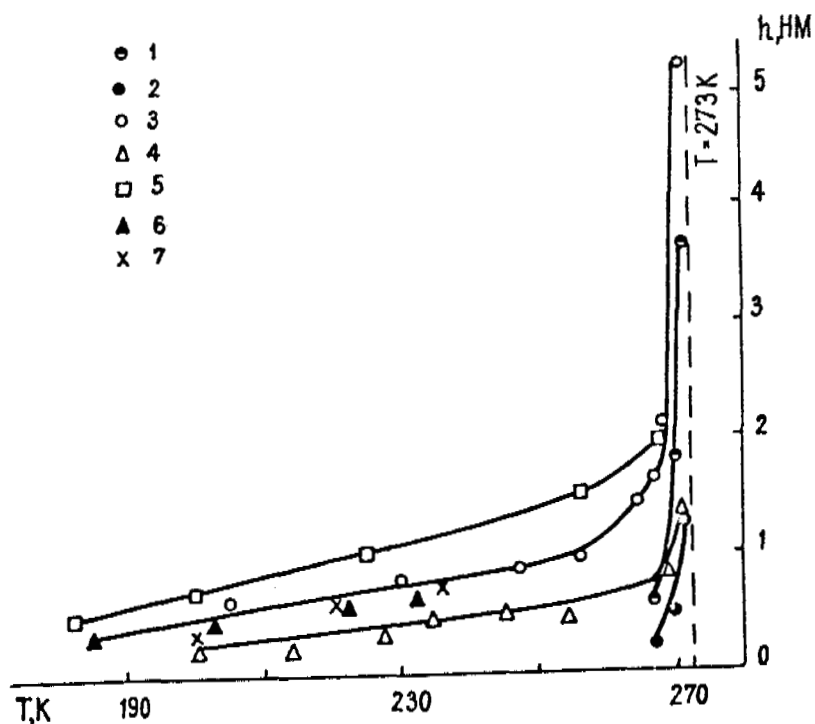

1) - the thickness of the mobile water layer as a function of temperature for dispersed ice; 2) - and frozen aqueous dispersions of: polyfluoroethylene; 3) - silica powder; 4) - Na-montmorillonite; 5) - Ca-kaolinite; 6) - silica powder samples; 7) - and silica gel with adsorbed water.

In crystals with a large specific surface the phase transition has a diffuse character, since an observable quantity of the liquid phase has been recorded within a certain temperature interval below 273 K. This is due to the heterogeneous nature of the matter at the phase interface.

The problem of "diffuse" phase transitions is examined in detail in B.N. Rolov's monograph (1974), where it is shown that the major cause of the spread is the non-homogeneous physical state of the matter. The heterogeneity should be particularly conspicuous in a system composed of small entities varying in size and shape, i.e., in a dispersed medium. As may be deduced from theoretical analyses of phase transitions, in a system of finite dimensions point phase transitions do not occur at all; consequently,

the smaller the sample, the more markedly diffuse ("washed out") the corresponding phase transition (Fisher, 1968; Hill, 1963). Theoretical analyses of the results of our experiments are complicated by the absence of a general theory concerning the fusion of solids (Ubbelode, 1969).

In a number of studies (see, for example, the survey in Kiselev's work, 1970) the drop in the temperature of the phase transition of water  $\Delta T$  in porous bodies is attributed to the decrease in the elasticity of water vapours above the meniscus in capillaries with the radius  $r$ . V.A. Bakaev et al., (1959) have demonstrated that the theory of capillary condensation cannot provide an unambiguous explanation of the experimental dependencies  $\Delta T(r)$ . As may be seen from Figure 5 borrowed from that work, the data obtained for non-porous dispersed bodies (silica powders) show a good agreement with the experimental dependency  $1/r$  ( $\Delta T$ ) of porous silica gels.

Figure 5

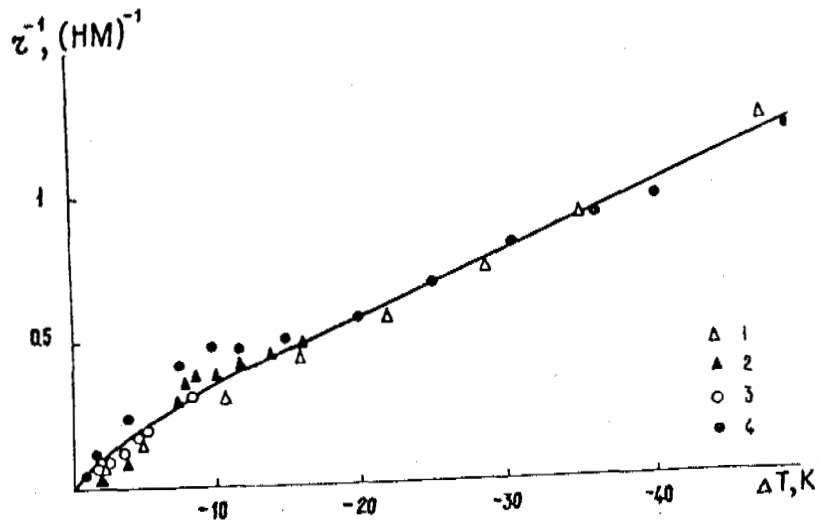

- 1) - magnitudes of inverse radii of interstices (pores) as a function of the drop in the melting point of water according to the data obtained from dilatometric (Puri et al., 1957);
  - 2) - and calorimetric measurements (Bakaev et al., 1959).
- 1, 2, 3 and 4 - silica gels, 3 - non-porous silica powder.

It has been demonstrated (Bakaev et al., 1959, Kvlividze, Kiselev, 1967; Kiselev, 1970) that a drop in the melting point of an adsorbed phase can be interpreted more loosely, regardless of the shape of the meniscus, as

a general property of the matter in dispersed state. The data from Figure 4 support this hypothesis. The thickness of the films  $h$  on a porous adsorbent (i.e., silica gel) coincides with  $h$  of the non-porous silica powder. According to the theories of Tamman-Folman, the melting point of a dispersed surface phase depends (all the other conditions being equal) on the characteristic size  $h$  of that phase. A number of size-dependent surface effects are examined in Kiselev's work (1970).

The fact that the melting point  $\Delta T$  of small particles is lower than that of a massive sample may be due to the interphase energy being a function of the curvature of  $r$ . For example, to assess the law governing the change in  $\Delta T/T_{\infty} \sim Ar^{-1}$  for spherical metallic particles (Gladkikh, Khodkevich, 1971)\*. The constant  $A$  depends on the parameters of the dispersed phase, which are usually unknown. The course of the dependence  $\Delta T/T_{\infty}$  agrees qualitatively with the data of Figure 5, but in terms of a phenomenological analysis the lowering of the melting point of ice on the surface of hydrophilic solids cannot be calculated quantitatively without knowing the surface tension coefficients at the interphase boundary (Chistotinov, 1973).

In finite crystals and even more so in dispersed bodies the process of melting begins at the interface between the particles and the vapour or, in the event of adsorption films and dispersion, of the solid phase. Theoretical calculations indicate that the mean square of the amplitude of oscillations in surface atoms i.e.,  $\langle X_S^2 \rangle$  is invariably higher than that inside the crystal  $\langle X_V^2 \rangle$  (Maradudin, 1968). As is well known, the quantity  $\langle X_V^2 \rangle$  is inversely proportional to the square of Debye temperature in the approximation of a harmonic oscillator. Since  $\langle X_S^2 \rangle > \langle X_V^2 \rangle$ , Debye's temperature for the surface phase  $\theta_{DS}$  is lower than it is for the bulk of the body.

In Debye's approximation the initial melting of a crystal may be characterized by Lindeman's temperature (Maradudin, 1968)

---

\* This sentence appears to be incomplete. (Translator).

$$T_{\text{melting}} \sim (ad)^2 m k \theta_{DV} / 3h^{-2},$$

where  $a \sim 0.1 - 0.2$ ;  $m$  is the mass of an atom, and  $d$  is the average distance between the atoms. Since  $\theta_{DS} < \theta_{DV}$ ,  $T_{\text{melting}}$  will be lower on the surface. These effects can be expected to be particularly conspicuous in dispersed particles, where the surface phenomena sharply increase in importance.

#### REFERENCES

1. ABRAGAM A. Yadernyi magnetizm (Nuclear magnetism). Moscow, IL, 552 pages, 1963.
2. BAKAEV V.A., KISELEV V.F. and KRASIL'NIKOV K.G. Ponizhenie temperatury plavleniya vody v kapillyarakh poristogo tele (Drop in the melting point of water in capillaries of a porous body). - "Dokl. AN SSSR", Vol. 125, pp. 831-843, 1959.
3. BEREZIN G.I., KOZLOV A.A. and KUZNETSOVA L.V. Kalorimetricheskoe issle-fazovogo perekhoda kapillyarnogo kondensata (Calorimetric study of phase transition of capillary condensate). - V. kn.: Poverkhnostnye sily v tonkikh plenkach i dispersnykh sistemakh. Moscow, "Nauka", pp. 202-209, 1972.
4. GAUROVITS R. Khimiya i funktsiya belkov (Chemistry and function of proteins). Moscow, "Mir", 530 pages, 1967.
5. GLADKIKH N.T. and KHODKEVICH V.I. Opređenje poverkhnostnoi energii tverdykh tel po temperature plavleniya dispersnykh chastits (Determination of the surface energy of solids from the melting point of dispersed particles) - "Ukr. fiz. zhurn.", Vol. 16, pp. 1429-1436, 1971.
6. KVLIVIDZE V.I. and KISELEV V.F. Issledovanie fazovykh perekhodov v adsorbir-vannoi vode metodom YaMr (NMR study of phase transitions in adsorbed water). - "Zhurnal strukturnoi khimii", Vol. 8, pp. 221-226, 1967.
7. KVLIVIDZE V.I., KRASNUSHKIH A.V. and MOROZOV L.L. Issledovanie sistemy kaolinit-voda metodom protonnogo magnitnogo rezonansa (Study of the kaolinite-water system with the use of proton magnetic resonance techniques). - V khn.: Svyazannaya voda v dispersnykh sistemakh, Issue 2, Izd-vo MGU (Moscow University Publishing House), pp. 97- 105, 1972.
8. KVLIVIDZE V.I., ANANYAN A.A., KRASNUSHKIN A.V. and KURZAEV A.B. Vliyanie mezfaznoi granitsy na plavlenie l'da v geterogennykh sistemakh. (The effect of the phase interface on melting of ice in heterogeneous systems). - V kh.: Svyazannaya voda v dispersnykh sistemakh, Issue 3, Izd-vo MGU (Moscow University Publishing House), pp. 120-126, 1974.

9. KISELEV V.F. Povekhnostnye yavleniya v poluprovodnikakh i dielektrikakh (Surface phenomena in semiconductors and dielectrics). Moscow "Nauka", 400 pages, 1970.
10. KISELEV V.F., KVLIVIDZE V.I. and KURZAEV A.B. Poverkhnostnye yavleniya na granitse led-gaz i led-tverdoe telo (Surface phenomena at the ice-gas and ice-solid boundaries). - V kn.: II Mezhdunar. konf. po merzlotovedeniyu (Second International Conference on Permafrost), Issue 4, Yakuts, pp. 199-202, 1973.
11. KRASIL'NIKOV K.G. and SKOBLINSKAYA N.N. Sorbtsiya vody i nabukhanie montmorillonita (Sorptions of water and swelling of montmorillonite). - V kn.: Svyazannaya voda v dispersnykh sistemakh, Issue 2, Izd-vo MGU (Moscow University Publishing House), pp. 66-85, 1972.
12. KURZAEV A.B., KVLIVIDZE V.I. and PCHELIN V.A. Izuchenie metodom YaMR zamozhennoi predel'no-gidrofobnoi suspensii ftoroplast-voda (NMR study of a frozen extremely hydrophobic polyfluoroethylene-water suspension). - "Dokl. AN SSSR", Vol. 108, pp. 391-393, 1973.
13. KURZAEV A.B., KVLIVIDZE V.I. and KISELEV V.F. Ob osobennostyakh fazovogo perekhoda vody v dispersnykh sistemakh (Distinctive aspects of the phase transition of water in dispersed systems). - "Biofizika", Vol. 20, pp. 533-534, 1975.
14. PCHELIN V.A. O modelirovani gidrofobnykh vzaimodeistvii (Modelling of hydrophobic interactions). - "Dokl. AN SSSR", Vol. 194, pp. 521-624, 1970.
15. ROLOV B.N. Fizicheskie svoistva razmytykh fazovykh perekhodov (Physical properties of diffuse phase transitions). Riga, Izd-vo Latb. un-ta (Latvian University Publishing House), 312 pages, 1974.
16. SKLYANKIN A.A. and KIREEV K.V. O mekhanizme vzaimodeistviya vody s poverkhnost'yu kaolinita (Mechanism of interaction of water with the surface of kaolinite). - V kn.: Svyazannaya voda v dispersnykh sistemakh, Issue 2, Izd-vo MGU (Moscow University Publishing House), pp. 86-96, 1972.
17. CHISTOTINOV L.V. Migratsiya vlagi v promerzayushchikh nevodonasy-schchennykh gruntakh (Migration of moisture in freezing soil materials unsaturated with water). Moscow, "Nauka", 144 pages, 1973.
18. UBBELODE U. Plavlenie i kristallicheskaya struktura (Fusion and crystalline structure). Moscow, "Mir", 420 pages, 1969.
19. FISHER M. Priroda kriticheskogo sostoyaniya (Nature of the critical state). Moscow, "Mir", 222 pages, 1968.
20. FLETCHER N.H. Surface structure of water and ice. II. A revised model. - "Phil. Mag.", Vol. 18, pp. 1287-1300, 1968.
21. HILL T.L. Thermodynamics of small systems, P.I. N.Y. - Amsterdam, XII, 171 pages, 1963.



22. KVLIVIDZE V.I. Specific features of phase transition of finely-divided solids from NMR data. - In: Magnetic resonance and related phenomena. Proc. XVI Congr. AMPERE, Bucharest, pp. 390-392, 1971.
23. KVLIVIDZE V.I. et al., The mobile water phase on ice surfaces. - "Surface Science", Vol. 44, pp. 60-68, 1974.
24. KRASNUSHKIN A.V. and KVLIVIDZE V.I. NMR estimation of molecular mobility in systems with paramagnetic impurities. - In: Magnetic resonance and related phenomena. Proc. XVI Congr. AMPERE, Bucharest, pp. 694-697, 1971.
25. MOONEY R.W. et al., Adsorption of water vapour by montmorillonite. I. Heat of desorption and application of BET theory. II. Effect of exchangeable ions and lattice swelling as measured by X-ray diffraction. - "J. Amer. Chem. Soc.", Vol. 74, pp. 1367-1371, 1371-1374, 1952.
26. MORARIU V.V. and MILLS R. Self-diffusion of water adsorbed on silica. - "Z. Phys. Chem.", Vol. 79, pp. 1-9, 1972.
27. OLEJNIK S. and WHITE J.W. Thin layers of water in vermiculites and montmorillonites-modification of water diffusion. - "Nature. Phys. Sci.", Vol. 236, pp. 15-16, 1972.
28. PEARSON P.T. and DERBYSHIRE W. NMR studies of water adsorbed on a number of silica surfaces. - "J. Colloid Interface Science", Vol. 46, pp. 232-248, 1974.
29. PFEIFER H. Nuclear magnetic resonance and relaxation of molecules adsorbed on solids. - "NMR - Basic Principles and Progress", Vol. 7, pp. 53-153, 1972.
30. PFEIFER H. Surface phenomena investigated by nuclear magnetic resonance. - "Physics Reports (Section C of Physics letters)", Vol. 27, pp. 293-338, 1976.
31. PLOOSTER M.N. and GITLIN S.N. Phase transition in water adsorbed on silica surfaces. - "J. Phys. Chem.", Vol. 75, pp. 3322-3326, 1971.
32. PURI B.R. et al., Freezing points of liquids adsorbed on porous solids. - "Trans. Farad. Soc.", Vol. 53, pp. 530-534, 1957.
33. RESING H.A. Nuclear magnetic resonance relaxation of molecules adsorbed on surfaces. - "Advan. Mol. Relax. Processes", Vol. 1, pp. 109-154, 1967/68.
34. RESING H.A. NMR relaxation of adsorbed molecules with emphasis on adsorbed water. - "Advan. Mol. Relax. Processes", Vol. 3, pp. 199-226, 1972.
35. SCHUFLE J.A. et al. Temperature dependence of surface conductance and a model of vicinal (interfacial) water. - "J. Colloid Interface Science", Vol. 54, pp. 184-202, 1976.
36. MARADUDIN A. Defekty i kolebatel'nyi spektra kristallov (Defects and oscillating spectrum of crystals). M., "Mir", 432 pages, 1968.

## INVESTIGATION OF THE STRUCTURE AND PROPERTIES OF BOUND WATER

B.A. Savel'ev

Moscow State University, U.S.S.R.

The current state of knowledge of such a complex geological body as permafrost, from the position of physics and physical chemistry, makes it possible to construct a model that allows many of the properties, components and processes transforming the earth materials to be satisfactorily explained; it also allows the forecasting of changes in the permafrost under real conditions and the working out of specific ways of influencing the permafrost so as to achieve the characteristics desired.

Permafrost is a multicomponent, multiphase system found in subzero temperatures all components of which are joined together by structural bonds. The peculiarity of permafrost lies in the fact that it contains water in three states: gaseous, liquid and solid. The relationship between the various phases of water is determined by the complex interaction of water molecules with the molecules of the mineral skeleton, and also with the ions, molecules and particles of the substances found in the liquid phase. Therefore, it depends on the subzero temperature, and the type and concentration of substances dissolved in the liquid water; this includes adsorbed water.

The physico-chemical processes and structural transformations taking place in the earth materials, such as cation-exchange, migration, etc. bring about changes in these relationships. The properties of permafrost (electrical, mechanical, seismic, ultrasonic, etc.) are, to a certain degree, determined by the relationship between the phases of the water, which appears as a liquid anisotropic layer between the solid components. Depending on the above-mentioned conditions, the thickness of the liquid can vary from a monolayer of water molecules retained on the surface of the foreign body by

strong bonding forces, to a layer which is characteristically no different from free water, and which does not strengthen but rather, weakens it.

As stated above, a basic factor determining the characteristics of permafrost is the cohesive bond. The nature of these bonds can be explained by a model reflecting the peculiarities of structure in the near-boundary region of the permafrost arising from the multiplicity of layers between the mineral part of the skeleton and the ice. The multilayered system includes adsorbed water which in turn consists of a firmly bonded layer and a diffusion film, a mobile surface layer of ice and a contact layer of ice; all of these may undergo considerable transformation as a result of changes in the thermodynamic conditions and the physico-chemical processes.

The explanation of this interaction of water with the surface of the solid body is connected with the study of the nature of the centres of adsorption. Due to the number of uncontrollable factors imposed on the phenomenon being studied, the task of revealing the essence of the processes of adsorption of water in such complex heterogenic systems as unconsolidated materials meets with enormous difficulties. Consequently, researchers are attempting, with the help of a simple model system, to explain the basic patterns of the phenomenon of the interaction of the adsorbent. According to V.F. Kiselev and his co-workers (Ignat'ev et al., 1970) oxides are the most convenient model. They are the basic component of the overwhelming majority of soils. We are restricting ourselves to the view of mechanics of adsorption of water by oxides taken by V.F. Kiselev, L.A. Ignat'ev and V.I. Kvalividze, and we will use the evidence of mobility of water molecules as stated by O.Ya. Samoilov in 1957. The oxides have a hydrate surface containing hydroxide groups linked by valency to the surface atoms of the water molecules which, in a different way, interact with the oxygen atoms. In turn, the water molecules are linked together by hydrogen bonds. The bond between the hydrated surface of the oxides and the adsorbed water molecules is effected by the coordination mechanism. An example of this is the joining of two water molecules to the tetrahedrons  $\text{Si}(\text{OH})_4$ .

According to G.B. Bokie, the surface of monocrystals of clayey minerals is, as a rule, formed on the bases of hexagonal silicon-oxygenous

tetrahedrons. Water molecules fill the holes of the hexagonal lattice of the minerals. At the level of the lower oxygen atoms there are the depressions of the OH group of the octahedron layer: these bond the two atoms of Al and Mg. The proton of the OH group is transferred on the outside and can form hydrogen bonds with water molecules entering the depressions. Since the distance between the centres of the hexagonal lattice is 5.5 Å, and the distance between the molecules in the ice and the water is approximately 3 Å, the adsorbed water molecules can not join together to form hydrogen bonds and form a film of water with a normal structure. Moreover, the water molecules joined to the OH group by a hydrogen bond vibrate along the axis of the depression and jump from one depression to another, reminiscent of the relay movements of molecules in a volume of liquid. Since there are no hydrogen bonds in the compact monolayer due to the distance between the adsorbed water molecules, then their weakening influence on the bonding of water molecules to a foreign surface is considerably reduced. Consequently, the bond between the foreign surface and the water molecules increases by several orders; this is reflected in the intensity of the relay transfer of the water molecules in this layer.

According to A.A. Sklyankin and K.V. Kireev (1972), the adsorption of water by a kaolin surface is conditioned by the coordination bonds of the Al and Si atoms for the first lot of water. Further adsorption can proceed on the OH groups by hydrogen bonds.

It follows that the destination of water molecules during the formation of the monolayer depends on the crystal chemistry of the sublayer. The question arises: what can we consider to be the monolayer of water? Apparently, under normal thermodynamic conditions, when there are no outside influences and when there is stable composition and structure, the sublayer surface is saturated to a degree such that the indirect bonding of water molecules cannot take place.

When considering the adsorption mechanism of the bond, it should be considered that the chemical processes on the surface may exert an influence on the electrochemical and ion-exchange properties. In natural substances, cation-exchange takes place and this leads to complications in

the adsorption processes. By using the magnetic resonance method, a considerable reduction in the mobility of the water molecules was achieved (Kvlividze, 1970). By increasing the quantity of water, the mobility of the molecules increases. On zeolite, for example, when there is only a little water, the water molecules are only bound with the cation of the skeleton. An increase in the number of adsorption molecules leads to an increase in the average number of molecular bonds. As a result, hydrogen bonds appear between the water molecules, and the adsorption energy decreases. The mobility of the adsorption molecules of the water diminishes in a number of zeolites containing K, Na, Ca, Zr, and ice; this agrees with the view held by O.Ya. Samoilov concerning negative and positive hydrating ions. Thus, the structure of the layer of adsorption water near the surface of the sublayer is connected with the geometry of the distribution of active centres and will differ significantly from the structure of ice and the stereometry of free water.

In contrast to the spatial structure of the crystal lattice, which has saturated bonds of different types forming its structure coordination in the border regions, for various reasons, uncompensated charges appear. One reason for the appearance of spare charges is the dissociation of molecules from the hard surface of the clay particles onto the ions. Some of the ions diffuse into the dispersion medium and those remaining, bonded with the hard phase, serve as a spare source of charge for the particle surfaces. In some cases, there is completion of the crystal lattice, as a result of the adsorption of ions from solutions; this is due to the occurrence of closer chemical bonds which prevents them from dissolving back again. Cation exchange resulting from the substitution of the hydrogen in OH groups by the metallic ions intensifies with a strengthening of the pH medium.

Thus, near the boundary of the unconsolidated materials and the solution, adsorption centres form which are qualitatively characterized by the differing crystalline structure of their surface minerals; by the differing composition and properties of the solutions contiguous to them, and by the differing dynamics of the physico-chemical processes in the boundary layers.

According to P.E. Zlochevskaya, P.S. Ziangirov, E.M. Sergeev and A.I. Rybachuk, (1970), the presence of a significant concentration of exchange cations in the firmly bonded part of the adsorption water determines the reduced solvent action; this is due to the screening of water molecules by the influence of both the cation fields and the surface particles. On the basis of calculation of the distribution of surface potential and the electrical capacitance of the double electric layer of clays between its diffused and firmly bonded ("boundary") parts, the above-mentioned authors came to the conclusion that firmly-bonded water is not involved in the electrokinetic processes. The opinion also exists that adsorbed water has an increased solvent action in comparison with unbound water, due to an increased dipole moment and consequently to increased dissociation of water molecules under the epitaxial influence of the sublayer.

The remainder of the absorbed water, the most mobile, is called "diffused". There is only a slight change in the specific unit capacitance of the firmly bound water in the various fine-grained materials. As for the capacitance of the diffused layer, its highest values is manifest in askanite gel\*: its lowest - in kaolin; this is determined by the number of ultrapores it contains which have a radius of up to 100 Å.

When studying the mobility of exchange cations ( $\text{Na}^+$ ,  $\text{K}^+$ ,  $\text{Li}^+$ ) in bentonite, R. Low and D. Anderson (Low, Anderson, 1958) determined the connection between the structure of bound water and the type of cation.

In unconsolidated materials, the ice crystals can be formed from adsorbed water, unbound water, or from solutions of water vapour, contained within the frozen body. Recrystallization may also take place. This is caused by the internal thermodynamics, the thermochemical and migration processes. The condition necessary for formation and growth of crystals from a liquid environment is the supercooling of the liquid environment, or a change in the concentration of the dissolved substances it contains. Supercooling of the liquid environment of the supersaturation of the vaporous

---

\* Askanite gel - acid activated clay, a montmorillonite-like clay occurring as a decomposition product of volcanic ash. (Technical Translator).

phase brings about a change of temperature, pressure, volume, concentration, etc. The formation and growth of crystals in a liquid is dependent upon the speed of accumulation of molecules around the centre of crystallization, and their ordering in the ice lattice. The speed of accumulation is determined by the relay movement of the water molecules in the liquid; and the speed of their ordering in the lattice points is dependent both on the energy of the water molecules themselves and on the strong field around the mineral sublayer, i.e., the epitaxial influence. The question arises: where are the most favourable conditions for the occurrence of a centre of crystallization in free water, in diffused or firmly bonded layers in subzero temperatures? Observation shows that, during changes of phase composition in permafrost when the temperature falls, the adsorption layer of water remains, even when the temperatures are very low. It has not yet been established at what temperature adsorbed water transfers completely into ice. The firmness of molecular bond in the adsorption layer is many times greater than the bond between the molecules in the ice lattice. On the other hand, the probability of occurrence of centres of crystallization in free water, a homogeneous environment, is considerably less than in conditions of heterogeneous formation. It can therefore be assumed that the most probable occurrence of centres of crystallization is in the diffused layer, in which there is diminished relay movement, and that there is epitaxial ordering of molecules.

When centres of crystallization have formed, they spread laterally in the free water and thus form a contact layer of ice, the structure of which is determined by the epitaxial action of the adsorption layer. This is supported by Savel'ev's results (I.B. Savel'ev, 1971) from simulation of the freezing-over of water on several permafrost samples in a cold chamber, and by subsequent study of the structures of ice formations in the contact layer and in the more distant horizons of the ice coating. It was established that there are contact layers with a specific structure that differs from the rest of the ice which is further from the mineral surface. The thickness of the contact layer depends on the inflow of moisture to the ice which is forming at the boundary of the liquid adsorption layer and which vacillates within the limits of fractions of a millimetre to 5 mm. Due to orthotropic growth, the crystals are considerably larger at 3 cm from the sublayer surface than they are in the contact layer. The influence of the surface of the base, and

consequently, of the adsorption layer of water, is clearly visible in the dimensions and forms of the crystals, and is scarcely discernable in the character of the dominant orienting optical axes. Under identical thermodynamic conditions of formation, the dimensions of the crystals diminish progressively as the influence of the base increases: glass; quartz layer, frozen sand, frozen kaolin; frozen askanite gel. When the temperature of the freezing over was  $-5^{\circ}$  the size of an average ice crystals on frozen sand was 7 times greater than that on frozen askanite gel.

Crystal size decreases with a lowering of the freezing-over temperature, and the influence of the character of the sublayer levels off. Apparently, in temperatures which are well below zero, when the intermediate, liquid layer between the surface of the frozen earth materials and the ice will be thick enough, the bonding forces between the water molecules that are furthest from the mineral sublayer are reduced considerably and will approach the strength of those between the molecules of free water. Under these conditions, the influence of the adsorption layer on the formation of ice is not strong enough to influence the structure of the ice that is forming, and contact ice may or may not occur. In this case, the ice covering will be homogeneous in structure throughout its mass.

As a rule, when there is little moisture and a low temperature, individual crystals form (massive structure); contact ice does not occur.

When studying the distribution of cations in freshwater ice coatings, I.B. Savel'ev (1973) discovered that the content of  $\text{Ca}^{2+}$ ,  $\text{Mg}^{2+}$ ,  $\text{Na}^{+}$ , and  $\text{K}^{+}$  increases with distance from contact with the adsorption layer of water. Thus, the influence of the adsorption layer is felt not only on the structure of the contact layer, but also on the redistribution of their chemical inclusions.

Study of the NMR spectra of polycrystalline ice undertaken by V.F. Kisilev et al., (1973) revealed the presence of a mobile layer (liquid) on the surface of ice bodies in temperatures below melting point. The mobile layer is found on an ice-gas surface or the surface of ice and any other hydrophobic body. The mobility of the elements of the lattice of the



disordered surface layer was considerably higher than in the body of the crystal. Lowering of the temperature was accompanied by a diminished mobility in the near-surface layers. It can be assumed that the nature of high mobility of lattice elements at the surface of the ice is conditioned by the specific mobility of hydrogen atoms; this was revealed earlier (Owston, Lonsdale, 1948). When the temperature is below  $-78^{\circ}\text{C}$  there is decrease in the mobility of hydrogen atoms in the ice; its solidity increases spasmodically; and the ice transforms from its liquid state into a solid according to Rebinder, reaching its endurance limit. When this occurs, the crystals transform from their hexagonal system into a cubic system. There is no sharp division between the mobile surface layer and the rest of the ice.

The discovery of a mobile layer on the surface of the ice provides an explanation for several processes occurring in natural ice formations. It is known that when glaciers flow slowly, when there is a stress field a reorientation of crystals takes place. It was not clear how this could happen. It can be supposed that the presence of differing reticular densities of molecules on the cleavage facets and faces of the crystals causes the differences in mobility; this has not been proven by experiment. Resulting from these positions, the shifting of the mass of matter at the surface is conditioned by the stress gradient and the different reticular density, i.e., by various relay movements it will lead to the formation of a more stable form and new orientation of the crystals.

I succeeded in finding an indirect affirmation of the presence of a mobile layer on the ice surface. This concurs with the experiments carried out by Barnes and Vaipond (1909) to determine the sublimation heat of pure ice: when there is rapid sublimation, the heat value was close to that of the evaporation of water and was on average, 608 cal/g, and 701 cal/g for slow sublimation, i.e., close to the energy of transition from indirect transformation from a solid to a vapour. This discrepancy, hitherto unexplained, can now be accounted for in the following manner: firstly the mobile layer of ice is quickly broken down, and then the deep layers are affected; this is caused by the diffusion of molecules within the ice. It can be proven that such a method for determining the energy of phase transition from ice to vapour allows the possibility of establishing the

mobility of water molecules, and subsequently the strength of their bonds with the ice surface, within the ice, and with the surface of a foreign body (including unconsolidated materials) - I can claim authorship of this method.

On the basis of the above, it can be considered that the unusual structure on the near-boundary region of permafrost results from its multiplicity of layers occurring between the mineral part of the skeleton, and the ice. The multilayered system includes adsorbed water comprising a firmly-bonded layer and a diffusion film, a mobile surface layer of ice, a contact layer of ice adjoining the remaining mass of the ice body.

The strength of permafrost comes about not as an additive result of the components and phases of the materials, but due to a specific type of cohesive bond conditioned by the intermediate multiplicity of layers. The adhesive bonds will be stronger than the cohesion strength of the ice when there is no diffusion layer of water. This can occur in very low temperatures when the ice will come in contact with the adsorption layer. Upon contact with the firmly bonded layer of water on the ice surface, very strong bonding occurs. This leads to a sharp reduction of molecules on the surface of the ice, and a firm bonding of these molecules with the adsorption layer seems higher than the firmness of the bonding between molecules within the ice lattice. In this case, the adsorbed water and the surface layer of the ice seem to be factors strengthening the permafrost.

As revealed by the experiments of I.B. Savel'ev (1972), in the presence of contact ice, in every case, the separation of ice from the permafrost bore a cohesive character and took place along the boundary of the contact ice - ice matrix separation. As a result of the breaking off on the sublayer surface a layer of ice 1 - 3 mm thick remained; this has the structure of a contact layer.

The firmness of the bond between the contact layer and the remaining mass of ice strengthens with an increase in number of crystals in the total volume and with a drop in temperature.

The cohesive strength of the ice become greater than the adhesive bond when there is considerably layer of adsorbed water, i.e., the diffusion

layer which can occur either when temperatures drop further below zero, or as a result of an increased concentration of dissolved salts in the diffusion layer. An increase in the layer of adsorbed water leads to a weakening of its bond with the ice, and this will increase the mobility of the molecules of the surface layer. Consequently there is a decrease in the firmness of the bonds with the mineral layer. In this case, the factors weakening the adhesion will be the diffusion layer and the mobile layer of ice.

Within the temperature interval from  $-1.5^{\circ}$  to  $-5^{\circ}\text{C}$ , the breaking away of ice from the surface of the sublayer had an adhesive-cohesive character. The relationship of the cohesion area to the adhesion area increases as the temperature drops. Beginning with a temperature of  $-5^{\circ}\text{C}$  and below, the breaking away was of a cohesive character in all experiments. In this case, the maximum strength is that of fine grained materials; this is conditioned by the structure of the contact ice.

It is to be expected that the structure of the contact ice stress field must change with time; without doubt this has an effect on the strength of the deforming and other properties of the permafrost.

I feel that future research into the near-border regions in permafrost will allow methods to be worked out for controlling the action, with a view to obtaining the desired properties of permafrost.

Structural parameters of congealed ice upon contact  
with fine-grained samples at  $-5^{\circ}\text{C}$   
(according to I.B. Savel'ev)

Sample	Coefficient of tortuosity C	Sectional area of mean crystal $S_{sr} \times 10^{-5} \text{ cm}^2$	Volume of mean crystal $V_{sr} \times 10^{-5} \text{ cm}^3$	Surface of crystals in unit volume P, $\text{cm}^2$
Askanite gel	2.56	185	26	102
Suglinok	2.61	295	48	82
Kaolin	2.37	452	77	68
Sand	2.37	884	177	57

REFERENCES

- IGNAT'eva L.A., KVLIVIDZE V.I. and KISELEV V.F. O mekhanizme elementarnogo akta vzaimodeistviya s poverkhnost'yu okislov. (Mechanics of the elementary event of interaction with the oxide surfaces). In the book: Svyazannaya voda v dispersnykh sistemakh, vyp 1. (Bound water in fine-grained systems, No. 1). Izd-vo MGU, 1970.
- ZLOCHEVSKAYA R.I., ZIANGIROV R.S., SERGEEV E.M. and RYBACHUK A.N. Issledovanie svoystv svyazannoi vody i dvojnogo elektricheskogo sloya systemy "glina-rastvor". (Research into the properties of bound water of the double electrical layer of the "Clay-Solution" system. Ibid, 1970.
- KVLIVIDZE V.I. Izuchenie adsorbirovannoi vody metodom Yaderno-magnitnogo rezonanso. (Study of adsorbed water by the nuclear magnetic resonance method). Ibid. 1970.
- KISELEV V.F., KVLIVIDZE V.I. and KURZAEV A.B. Poverkhnostnye yavleniya na granitse led-gaz i led-tverdoe telo. (Surface phenomena at ice-gas and ice-solid boundaries). In the book: II Mezhdunar. konf. po merzlovedeniyu, Doklad i sooloshch (II International Conference on Permafrost. Proceedings and Reports, No. 4, Yakutsk, 1973.
- SAVEL'EV I.B. Aktivnoe vozdeistvie merzlogo dispersnogo osnovaniya na strukturu prikontaktnogo sloya namorozhennogo l'da. (Effect on the structure of the near-contact layer of the encrusted ice by the activity of the frozen fine-grained base). "Dokl. AN SSSR", t. 201, No. 1, 1971.
- SAVEL'EV I.B. Osobennosti ledyanykh obrazovaniy vblizi kontakta s merzlymi gruntami. (Peculiarities of ice formations close to contact with permafrost). II Mezhdunar. konf. po merzlotovedeniyu. Dokl. i soobshch., vyp. 4. (II International Conference on Permafrost. Proceedings and Reports. No. 4, Yakutsk, 1973.
- SAVEL'EV B.A., SAVEL'EV I.B. and GOLUBEV V.N. Strukturnye osobennosti adgezii l'da s tverdymi telami. (Structural peculiarities of adhesion of ice to solids). 1972.
- SKLYANKIN A.A. and KIREEV K.V. O mekhanizme vzaimodeistviya vody s poverkhnost'yu kaolina. (Mechanics of interaction of water with kaolin surfaces). In the book: Svyazannaya voda v dispersnykh sistemakh, vyp. 2. (Bound water in fine-grained systems, No. 2). Izd-vo MGU, 1972.
- LOW P.F. and ANDERSON D. Soil Sci. Soc. Amer. Proc., Vol. 22, 1958.
- OWSTON P.G. and LONSDALE K. The crystalline structure of ice. "J. Glac." Vol. 1, 1948.
- BARNES H.T. and VIPOND W.E. Phys. Rev., 27, 453, 1909.



CONDITIONS AND GEOTHERMAL CONSEQUENCES OF THE MOISTURE EXCHANGE  
BETWEEN THE LITHOSPHERE AND THE ATMOSPHERE IN PERMAFROST REGIONS

P.F. Shvetsov

All-Union Research Institute of Hydrogeology and Geological Engineering  
Moscow, U.S.S.R.

As studies by leading Soviet scientists have shown (Ignatovich, 1944; Kamenskii, 1947, etc.), one of the main processes involved in the formation (quality and resources) of deposits of subsoil waters (aqueous solutions) is the exchange of water in the lithosphere-soil and lithosphere-water-reservoir (water courses) systems. The exchange of moisture in the soil-atmosphere and water (water courses) - atmosphere systems is being studied, of course, by meteorologists and hydrologists.

The exchange of water in the lithosphere as studied by hydrologists is an irreversible physiogeological process of water (aqueous solutions) migration in the various rocks and their occlusions - strata, rock masses and massifs with varying pressure fields (heads), moisture contents (concentrations), temperatures and electrical potentials. It is a special case of the exchange of mass in the lithosphere-soil and lithosphere-water-reservoir systems.

The principal factors underlying the exchange of water in these systems are the following:

- 1) tectono-orographic - the situation of a given area in the geostructure and mesorelief, and also in relation to the marine basins, i.e., the range of altitudes, angles and slope directions of the terrain surfaces;

- 2) lithologo-petrographic (corresponding to the unit of geo-structure), i.e., the constitution, structure, composition and properties of the strata, rock masses and massifs of the given area;
- 3) meteorological, i.e., the zonal-regional water and heat balance of the active layer and the local weather regime in this area.

Various combinations of these three independent heat-exchange and water-exchange factors constitute individual internal subjects of hydrological investigation, designated according to the kinds of heat-exchange and water-exchange geosystems involved. A water-exchange geosystem is the totality (complex) of the water and aqueous solutions of the strata, rock masses, rock massifs, soils and reservoir beds characteristic of a given geostructural form and lithologo-petrographic system.

It is obvious that every water-exchange geosystem is at the same time a heat-exchange geosystem. The idea of a complex hydrogeothermal approach to the study of the geothermal field in regions with layers of continuously frozen soils stem from its first investigator in northern Siberia. In a work devoted to the climate (and obviously therefore, not previously familiar to hydrogeologists) Academician A.F. Middendorf (1962, p. 395) wrote:

"In the earth's strata, as in a huge filter, water of every temperature is descending to different depths and is rising from different depths to different altitudes and intermingling, as a result of which the temperature of the ground strata are changed". This is not consistent, of course, with the belief that "permafrost is a product of climate" and with the contradictory existence of a considerable number of springs meeting the needs of the population and the economy in northern regions. The creative idea, here, resembled the permafrost-climate concept which was widely held towards the middle of the nineteenth century and which had developed from the study of surface phenomena and the composition of the subsoils; the investigation of the processes in their interior had not yet begun. The

first step in this promising, but difficult direction was taken by the geologist N.M. Koz'min (1898).

Among the generally known characteristics of the water exchange of the lithosphere with the soil and the atmosphere in the presence of a frozen geozone are the following:

1. A continuously frozen subsoil or "permafrost" with a thickness, as a rule, of more than 10 m constitutes a singular water-impermeable "gasket" between the soil and the comparatively deep (subpermafrost) strata and massifs of the lithosphere; in hydromechanical terms (as a water-confining layer), it is comparatively uniform, notwithstanding the variety of lithogenetic and petrographic forms and their complexes (strata, suites, series) entering into its constitution.

2. The interdependence of the soil, subsoil (super-permafrost) and interstrata waters is possible and is actually realized owing to the discontinuous character of the frozen zone of the lithosphere, marked by "problems", according to A.V. L'vov (1916) in the form of taliks of hydrological, hydrogeological, geochemical and mixed origin.

3. The cryogenic hydrogeological boundaries between the water-bearing and water-repelling horizons, massifs and veins especially the upper and lateral ones, change position in the course of annual and longer periods of time; they are not always determined by, and indeed are often completely independent of the common lithogenetic regularities such as the alternation of clay and sand deposits or of monolithic and fissured scaly rocks. The mobility of these boundaries agrees completely with V.I. Vernadskii's (1933) most important idea concerning the pulsation of the cryosphere, and has been confirmed by the investigations of students of permafrost who have demonstrated empirically that not only is "permafrost subject to degradation" but that this degradation is also accompanied by deep freezing processes in the earth's crust (Sumgin et al., 1940).

4. The surfaces of frozen rock strata (FRS) are cold screens on which water vapours coming down (in spring and summer) from the warmer



atmosphere and soil and up from the deeper, unfrozen horizons of the lithosphere condense (L'vov, 1916; Sumgin, 1937; Koloskov, 1937, 1938). In view of the considerable gas permeability of soils and rocks, their water exchange with the atmosphere is realized in large measure by diffusion and by turbulent (convective) transfer.

5. The replenishing of groundwater springs and the increase of river flows in many regions possessing icy frozen strata is due, apparently to the thawing of underground ice (Yachevskii, 1899; Tolstikhin, 1941). This phenomenon can be observed only during the warming half period of the cyclical alternation of heat exchange conditions of the earth's crust with the atmosphere; the opposite occurs during the cooling half cycle.

A number of other cryogenic factors must now be added to these generally known characteristics of the water exchange of the lithosphere with the soil and the atmosphere in permafrost regions. One of these is due to the low geothermal level of the heat exchange. The basis of this lies in the fact that the temperature of the soil, subsoil and interstrata waters that moisten the FRS remain, over long periods (one warm season to many years), in the interval between  $+4^{\circ}\text{C}$  and the freezing point of the aqueous solution. The anomalous variation of the density of fresh water in this interval plays an extremely important part in the energy and water exchange of the earth's crust with the soil and the water reservoirs of high latitudes.

An entirely different, but no less important hydrogeothermal effect is observed when fissures and other macrospace fill up with aqueous electrolytic solutions whose concentrations exceed 26 g/litre. The maximum density of these solutions, which have lost the character of water, corresponds to the lowest temperature. Accordingly, anomalous temperature fields are created in the fissured rock strata - with negligibly positive or even negative geotemperature gradients. To some extent this constitutes a refinement of V.I. Vernadskii's (1933) belief in the great importance of the cooling zone in the earth's crust for the development of certain geophysical and geochemical processes.

A second further condition of development of the water exchange of the earth's crust with the atmosphere and water reservoirs in the Far North

lies in the increased importance of the "gas factor" in the movement of subsoil waters across open taliks, since the total gas saturation of the interstrata waters here is greater than in areas devoid of frozen rock strata (Shvetsov, 1951). Often the motion of ground and interstrata waters across an open talik under the influence of the gas factor will be a two way motion; the dense (cold) groundwater moves downwards, while the gaseous interstrata water moves upwards through the same relatively large talik occupied crack or seam; the downward motion of dense soil and groundwater will predominate in the warm season, the ascending mixtures of water and gases in the cold season.

A third singular condition of the water exchange between the soil and the atmosphere in the presence of an FRS can be identified as increased temperature gradients in the seasonally thawed layer (Principles of geocryology, 1959). Reflecting the great intensity of the temperature field in the upper shell of the earth's crust, these enhanced temperature gradients increase the heat and moisture transfer of the capillary porous soils and rocks when the signs of the temperature and moisture gradients of the rock or the signs of the temperature and density of the water are the same, which occurs in spring and at the beginning of summer. The same may be said of the diffusion of atmospheric humidity in coarse-grained and clastic formations.

The positive energy effect of the seepage (infiltration) of atmospheric water into the soil and rocks must be deemed an extremely important characteristic of the water exchange of the lithosphere with the soil and the atmosphere in the Far North. A considerable access of heat in the subsoil is attributable to the infiltration of atmospheric precipitations. The periodic measurement of rain water temperatures in Noril'sk has shown that it can be as much as  $15^{\circ}$  -  $18^{\circ}\text{C}$  there. Just the opposite is observed in the extreme South, in the sandy deserts of Central Asia, for example. In the Kara-Kums the falling and infiltration of precipitations into the unsaturated sandy soils (zone of aeration) lowers the subsoil temperature.

It should be emphasized that it is a question here of the thermal effect of infiltration, not of the amount of precipitation and the influx of

surface water from surrounding areas. The geothermal effect of the absorption of surface moisture by the unfrozen soil and its percolation downwards to the frozen soil-subsoil layer with an annual heat reversal in a number of places is not synonymous with the overall thermal effect of the fall of atmospheric precipitations or with any other form of moistening of the underlying surface. Investigations in the Upper Bureya basin have clearly shown that rain-drenched horizontal and gently sloping (less than 5°) areas and zones in depressions and on flat interfluvial areas with peaty boggy soils and clayey subsoils are characterized by very low negative subsoil temperatures (Bakakin et al., 1954).

The infiltration of 150 - 300 mm precipitation and surface runoff water over the spring and summer season into a coarse-grained, fissured layer of the earth's crust with annual heat reversals is a principal cause of the formation of azonally warm massifs of the lithosphere (year-round and frequently open taliks) in northern and northeastern regions where the mean annual atmospheric temperatures are -5° to -15°C. The infiltration also changes the structure of the basic annual heat balance equation by the introduction of an additional term and reduces its common component which expresses the loss of heat in the evaporation of moisture (Shvetsov, 1968). Taking this into account, the following equation is obtained;

$$T_s = T_a + \frac{R - L(E - v) + cv\Delta T + B}{\alpha}$$

where  $T_s$  - soil temperature;  $T_a$  - temperature of the air;  $R$  - radiation balance;  $L$  - heat of evaporation of water;  $E$  - quantity of surface water remaining on the surface and inside the clayey soil;  $v$  - quantity of water seeping through the soil to the subsoil in the warm season;  $\Delta T$  - difference of temperature between the subsoil and the water that has penetrated into it from the surface;  $c$  - thermal capacity;  $B$  - flow of heat from the interior of the earth or from the soil into the lithosphere (totalled), and  $\alpha$  - coefficient of heat exchange due to convection.

Thus, the very important idea (Yachevskii, 1899) that the lithological composition of the rocks of a given area "determine, so to speak, the extent to which the soil is receptive to the external climatic

changes", requires an essential supplement. Besides the quantitative extent, the different direction "of receptivity of the soil" to the atmospheric precipitations and to surface moisture of other origin must also be taken into account.

In the light of what has been said about the nature of the water exchange conditions of the lithosphere with the soil (and atmosphere), the decisive importance of the lithologo-petrographical varieties of rock in the behaviour of groundwater in the Pechora coal basin district becomes entirely clear. There are whole sectors in which an ancient eroded crust of Permian rocks is covered by thick layers of practically water impermeable, and hence, as a rule, frozen clays. The behaviour of the subpermafrost water in these sectors reflects but faintly, if at all, the short term but radical changes in the conditions of water and heat exchange of the soil with the atmosphere. Just the opposite is observed in sectors of the Yun'yaginskii, Verkhne-syr'yaginskii type with thin, discontinuous anthropogenic ("morainic") formations.

The discontinuous character of the perennial cryolithozone, being an inevitable condition of the direct water exchange of the earth's crust with the atmosphere and water reservoirs, is also a consequence, as a rule, of the development of this complex physico-geological process. In order to be a cause of considerable discontinuity in the perennial cryolithozone the water exchange of the soil-subsoil complex with the atmosphere must be intense, i.e., there must be a sufficient quantity of surface water penetrating down to the subsoil or of subsurface water rising to the surface over a unit area during a given interval of time (year or season). Hence, this is one of the main hydrogeothermal problems in geocryology. As far as the extensive factor is concerned, i.e., the total area of water conducting open taliks, especially in relation to the total area of the perennial cryolithozone, it is considerable on its southern margins, but small in its arctic sector.

It may be said that the water permeability of the soil-subsoil complex is equivalent to its effective heat conductivity, which is beginning to be determined more and more by infiltration and influation, i.e., by

convective heat transfer. The mean annual temperature of the soil-subsoil complex is rising in proportion to the square root of its conductivity, i.e.,

$$\Delta T = x \sqrt{\Delta(km)}$$

where  $k$  - coefficient of filtration in m/day;  $m$  - thickness of layer exhibiting an annual heat exchange in m;  $x$  - a proportionality coefficient close to 0.05, as proposed by the hydrogeologist I.A. Zuev on the basis of studies of a large number of areas in the Northeast of the U.S.S.R.

#### REFERENCES

- BAKAKIN V.P., ZHUKOV V.F. and MEISTER L.A. *Mnogoletnaya merzlota gornyykh porod i usloviya stroitel'stva v tsentral'noi chasti Burenskoj vpadiny* (Permafrost in soils and conditions of construction in the central part of the Bureya valley). Moscow, Izd-vo AN SSSR, 110 pages, 1954.
- BARANOV I.Ya. *Yuzhnaya okraina oblasti zemnoi poverkhnosti* (Southern extreme of the earth's surface area). Leningrad, Gidrometeoizdat. 67 pages, 1956.
- VERNADSKII V.I. *Ob oblastiakh oxlazhdeniya v zemnoi kore* (On regions of cooling in the earth's crust). - "Zap. Gos. gidrol. in-ta", Vol. 10, (2), 1933.
- IGNATOVICH N.K. *O zakonomernostyakh raspredeleniya i formirovaniya podzemnykh vod* (On the regularities of distribution and formation of subsurface water). - Dokl. AN SSSR". Nov. seriya, Vol. 45, No. 3, pp. 133-136, 1947.
- KAMENSKII G.N. *Gidrogeologicheskie issledovaniya i razvedka istochnikov vodosnabzheniya (metodicheskoe rukovodstvo)*. (Hydrological investigations and the prospecting of sources of water supply (Methodological manual)). Gosgeolizdat. 79 pages, 1947.
- KOZ'MIN N.M. *O yavleniyakh vechnoi merzloty v nekotorykh mestnostyakh Vostochnoi Sibiri*. (On permafrost phenomena in Eastern Siberia). "Izv. Vost.-Sib., otd. RGO", Vol. 23, Issue 45, pp. 58-71, 1892.
- L'VOV A.V. *Poiski i opisaniya istochnikov vodosnabzheniya po zapadnoi chasti Amurskoj zheleznoi dorogi v usloviyakh merzloty pochvy (letnii i zimnii rezhim rek, gryntovykh vod i uslovii pitaniya glubokikh vodonosnykh tolshch v raionakh sploshnogo rasprostraneniya "vechnoi" merzloty)*. (The prospecting and descriptions of water supply sources along the western part of the Amur railroad in conditions of perennially frozen soil (summer and winter regimes of rivers, groundwater and conditions of feeding of the deep water-bearing strata in areas of dense distribution of permafrost)). Irkutsk, 882 pages, 1961.

- MIDDENDORF A.F. Puteshestvie na sever i vostok Sibiri. (Travel in the north and east of Siberia), Part 1, Issue 3, St. Petersburg, 270 pages, 1862.
- Osnovy geokryologii, (Principles of geocryology) ch. 1, M., Izd-vo AN SSSR, 1959.
- PONOMAREV V.M. Podzemnye vody territorii s moshchnoi tolshchei mnogoletnermerzlykh gornykh porod. (Groundwater of regions with thick layers of perennially frozen ground). Moscow, Izd-vo AN SSSR. 200 pages, 1960.
- SUMGIN M.I. Vechnaya merzlota pochvy v predelakh SSSR. (Permafrost soils in the U.S.S.R.). Vladivostok. 372 pages, 1927.
- SUMGIN M.I. Vechnaya merzlota pochvy v predelakh SSSR. (Permafrost soils in the U.S.S.R.). 2nd ed., Moscow, 380 pages, 1937.
- SUMGIN M.I., KACHURIN S.P., TOLSTIKHIN N.I. and TUMEL' V.F. Obshchee merzlotovedenie (General permafrost science). Moscow-Leningrad. Izd-vo AN SSSR, 340 pages, 1940.
- TOLSTIKHIN N.I. Podzemnye vody merzloi zony litosfery. (Groundwater in the frozen zone of the lithosphere). Moscow, Gosgeolizdat. 201 pages, 1941.
- SHVETSOV P.F. Podzemnye vody Verkhoyansko-kolymskoi gorno-skladchatoi oblasti i osobennosti ikh proyavleniya, svyazannye s nizkotemperaturnoi vechnoi merzlotoi. (Groundwater of the Verkhoyansk-Kolyma mining fold region and characteristics of their manifestation, associated with low temperature permafrost). Moscow, Izd-vo AN SSSR, 280 pages, 1951.
- SHVETSOV P.F. Zakonomernosti gidrogeotermicheskikh protsessov na Krainem Severe i Severo-Vostoke SSSR. (Regularities of the hydrogeothermal processes in the Far North and Northeast of the U.S.S.R.). Moscow, "Nauka", 112 pages, 1968.
- YACHEVSKII L.A. O vechnomerzloi pochve v Sibiri. (On permanently frozen soil in Siberia). - Izv. Russk. geogr. ob-va", Vol. 25, Issue 5, pp. 341-352, 1899.



RESULTS OF EXPERIMENTAL STUDIES OF THE FREEZING PROCESS  
IN VERY FINE-GRAINED SOILS

T.N. Zhestkova  
Moscow State University, U.S.S.R.

In recent years the interest in laboratory studies of the processes of freezing and of the cryogenic structures and textures of frozen earth materials has increased significantly. This is due to the largely hypothetical nature of the extant theories regarding the genesis of the cryogenic textures studied in natural profiles. Laboratory studies make it possible to model cryogenic structures and textures under definite specified experimental conditions, to reveal the congruence of various parameters of the system examined and of the factors affecting that system, with its controlled cryogenic structure and texture instead of inferring from the cryogenic structure and texture of a soil or rock its properties prior to freezing and during the freezing process. Evidence obtained from experimental studies of cryogenic structures and textures permits us to approach the search for solutions to the problems pertaining to the formation of cryogenic structures and textures of frozen soils or rocks differing in genesis, from more thoroughly substantiated positions. In this paper we outline results of investigations into the effect of the initial water content and density, rate of advance of the freezing front and distinctive features of primary textures and structures on the formation of inherited (after A.I. Popov) cryogenic structures and textures in fine-grained earth materials.

Laboratory studies on the formation of cryogenic structures and textures include the following: 1) modelling of the freezing process in fine-grained earth materials with concurrent observations on the dynamics of the development of ice lenses formation of cryogenic structures and their



reorganization in the frozen zone; 2) structural and textural-petrographic analyses of frozen earth materials and their constituents; 3) studies of the physico-mechanical properties of unfrozen earth materials and determination of the principal indices of frozen and thawing soils and rocks; 4) juxtaposition of the results of laboratory modelling with the data obtained in nature (from large natural profiles).

The diagram of a laboratory assembly, where freezing follows the pattern of a closed system, and the description of its major components and operating principles are presented in the papers by Zhestkova et al., (1976) and Zhestkova and Guzhov (1976). Due to transparent walls of the case we were able to photograph the samples continuously, around the clock, throughout the duration of the experiment, and to conduct observations on the advance of the freezing front, changes in the texture of frozen and unfrozen earth materials, and on the growth of ice lenses (Zhestkova, Guzhov, 1976).

The ground surface temperature was specified as constant for the duration of the freezing cycle or was varied according to the objectives of the experiment. The samples were tested within the temperature range of  $-1^{\circ}$  to  $-20^{\circ}\text{C}$ . The maximum duration of an experiment was 28 days, its minimum length was 5 hours. In the process of the research there were tested 269 soil samples measuring 60 x 60 300 mm, both with disturbed and undisturbed structures, with homogeneous or specified primary textures (Zhestkova, 1976, 1977).

Polymineral and monomineral earth materials of diverse genesis were studied. Monomineral soils were represented in the tests by kaolinite and bentonite clays, polymineral materials - by Paleogene clays, diluvial loams ("suglinok") and loamy sands ("supes"). The distinctive clayey-mineralogical characteristics of these soils and their physico-chemical properties are outlined in the works by Zhestkova and Guzhov (1976) and Zhestkova et al., (1976). These earth materials differ sharply from one another with respect for their capacity to form ice. The maximum ice formation is characteristic of monomineral earth materials. In polymineral clays containing minerals of the montmorillonite, hydromica, etc., group, there was recorded a generally lower ice content than that of

monomineral clays, development of small-scale cryogenic structures of the reticulate or layered type, and a reduction in the magnitude of heave of 1.5 to 2 times.

The initial moisture content  $W_H$  of the samples examined ranges from the lower plastic limit  $W_p$  to the moisture content exceeding the upper liquid limit  $W_L$ . Water-saturated earth materials were thoroughly frozen (degree of saturation with water 0.87 - 0.95). The different initial moisture contents and soil densities were ensured by preliminary compaction of the earth materials with the loads varying from 0.2 to 60 kg/cm<sup>2</sup>. This research is conducted under the supervision of Prof. V.A. Kudryavtsev.

#### THE EFFECT OF THE MOISTURE CONTENT AND DENSITY

The degree to which earth materials varying in composition and genesis are saturated with ice under the same type of freezing conditions, is determined by their initial moisture content and density (Zhestkova, 1973). A decrease in the density or an increase in the moisture content leads to a more active formation of ice lenses and intensifies the heaving of the ground. This was recorded in all the samples studied at different temperatures of freezing. It has been established experimentally that the critical density and moisture content of earth materials do not represent magnitudes constant for a given type of soil or rock, but are a function of the rate of freezing determined by the temperature at the freezing surface, heat flux in the unfrozen zone and properties of the earth material. For example, at the surface temperature equal to -2°C, segregated ice formed at  $W_H = W_p$ , whereas at the temperature of -6°C,  $W_H = W_p + 7\%$ . The effect of the initial density and moisture content was studied within a large range of variations in the rate of freezing with the temperature at the surface of the samples ranging from -2 to -10°C. The existence of a threshold in the formation of segregated ice permits us in many cases to avoid heaving by subjecting either the soil or rock of the foundation or the construction material to preliminary processing.

The formation of a massive cryogenic structure at the moisture content and density indices below the critical values is accompanied by

changes in the moisture content within the confines of the frozen and unfrozen zones, by partial heaving of the ground, increased porosity of frozen soils or rocks versus that of unfrozen earth materials, and by uneven distribution of ice-cement in the frozen zone.

### THE DYNAMICS OF THE MOISTURE CONTENT DURING THE FREEZING

In all the samples tested, excepting that of bentonite clay, there was recorded a change in the moisture profile during the cooling of the soil, but prior to the beginning of freezing. During that phase the moisture content of the sample increases by 4 - 5% in the uppermost 2 - 3 cm thick layer.

As the frozen zone increases in thickness, the zone of unfrozen earth materials (or the zone of influence) grows and its field of the moisture content alters perceptibly. The size of the zone of influence depends on the rate of advance of the freezing boundary, on the saturation of the frozen zone with ice.

The moisture content of the earth material at the freezing boundary is unstable, being a function of the freezing process (Zhestkova, Shur, 1974) (Figure 1).

Figure 1

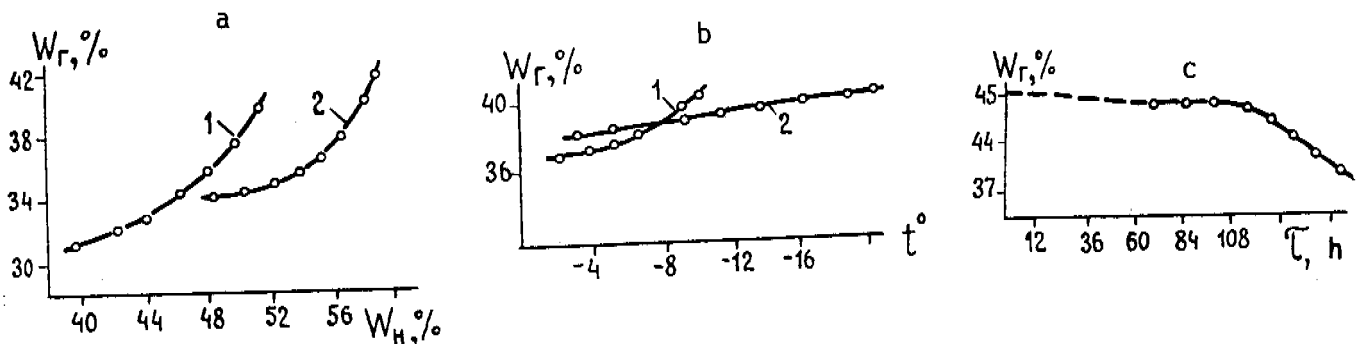

- a) Changes in the moisture content at the freezing boundary as a function of the initial moisture content of the earth materials,
- b) freezing temperature, and c) duration of the test.

## CRYOGENIC STRUCTURES AND TEXTURES

In the event of the surface temperature remaining constant throughout the duration of the test, there forms in the frozen zone of the samples a certain conjunction of horizons differing with respect to their cryogenic structures and succeeding one another in the vertical sequence of earth materials. This order of succession of the cryogenic structures generally corresponds (except for the layered cryogenic structure of the bottom horizons) to the pattern of distribution of structural horizons in natural profiles of the epigenetic type (under conditions of a closed system with a homogeneous composition), where small-scale cryogenic structures become replaced in the ascending order along the section by reticulate or massive structures (Zhestkova, 1966). A drop in the ground surface temperature or a decrease in the initial moisture content at a constant surface temperature leads to a reduction of the total moisture content of the earth materials within the frozen zone, to a shift of the moisture content maximum in depth, to the development of predominantly reticulate cryogenic structures in the profile and to a generally lower level of saturation of the earth materials with ice. A definite ice content corresponds to each particular type of the cryogenic structures confined to the structural horizon. It has been observed that the structural horizons are saturated with ice unevenly in the vertical section. Even though the possible amount of ice formed within the soil or rock which freezes according to the pattern of a closed system, is invariably restricted by the initial moisture content of the sample, in isolated tests the heaving of clays and loams attained 3.8 - 4.3 cm at the thickness of the frozen zone amounting to 10 - 13 cm.

It has been established experimentally that the formation of cryogenic structures and the ice content are not only functions of the absolute values of the surface temperature, but also depend on the magnitude of the heat flux from the bottom and, in a more general way, on the rate of freezing of the earth material.

Graphs depicting changes with depth in the rate of freezing and total ice content are presented in Figure 2. Concurrent examination of these graphs reveals close relationship between them; moreover, the higher the rate

of freezing, the lower the ice content, and vice versa. We did not control the rate of freezing in the tests. In the absence of the moisture redistribution by depth and of the formation of zones with increased accumulation of ice, the changes in the rate of freezing should be roughly proportionate to  $\sqrt{t}$  provided the surface temperature remains constant. The significant deviation from this law of freezing, the alternation of increases and drops in the rate of freezing shows that the accumulation of ice is not determined by the rate of freezing alone. By modifying the moisture content field in the unfrozen zone, the accumulation of ice also controls the migration of moisture to the freezing front and determines the character of the advance of the crystallization front.

Figure 2

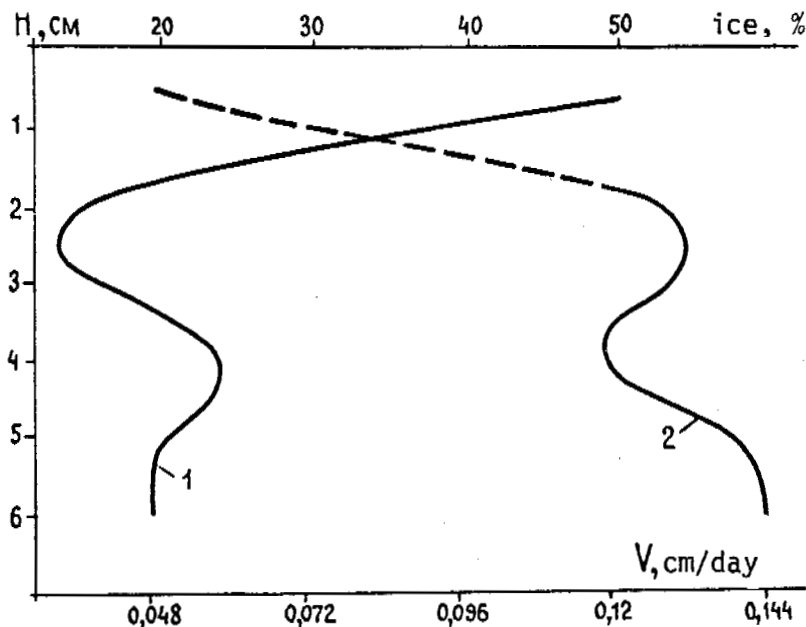

- 1) changes with depth in the rate of freezing, and
- 2) total ice content in the sample.

There has been observed an interdependence between the rate of freezing and the character of cryogenic structures and textures. With respect to the rate of freezing, the earth materials may be subdivided into the following three groups: soils with I - compound, reticulate or layered, II - microstreaky or microreticulate, and III - massive cryogenic structures.

The rhythmical pattern of the advance of the freezing front is often interpreted as a combination of stops during the formation of ice

layers and jumps during the freezing of thin mineral interlayers. We ought to distinguish two completely dissimilar cases of immobility of the freezing boundary. The first case is the stationary state arising in the event of heat fluxes in the frozen and unfrozen zones being equal. No crystallization of water occurs at the freezing boundary. The migration of moisture in the unfrozen zone on account of the gradient in the moisture content leads to its uneven distribution within the unfrozen zone. The flow of moisture at the boundary is nil. The second case is the growth of an ice lens. The rate of freezing is here not equal to zero and there occurs heaving, i.e., a change in the volume of the frozen zone. The analytical expression of these two cases was examined in an earlier paper (Zhestkova, Shur, 1974), where the distinctive aspects of specifying the conditions at the freezing boundary were also discussed.

Since the rate of freezing is a function of both the external conditions and the freezing process, the rates of formation of cryogenic structures within the body are not necessarily close in magnitude even when these structures are of the same type. For example, ice-cement forms in thin mineral interlayers at different rates of advance of the freezing front, which do not preclude the formation of segregated ice in other circumstances.

Experiments have shown (Zhestkova, 1977) that the rate of freezing of an earth material containing only ice-cement, may be even lower than the rate of freezing of a soil or rock with segregated ice.

#### OBSERVATIONS ON FORMATION OF CRYOGENIC STRUCTURES

Observations on the dynamics of freezing through transparent walls of the case have shown that in the course of the experiments lasting for a period of up to 28 days, there occurs a very slow, but continuous restructuring of ice lenses and reorganization of the cryogenic structure of the soil or rock in the frozen zone (Zhestkova, Guzhov, 1976). Figure 3 shows several photographs of a freezing clay sample at different points in time in the course of the experiment. Studies on the dynamics of the freezing processes and formation of structural elements suggest the following conclusions. The distinctive morphology (i.e., the design or the general

Figure 3

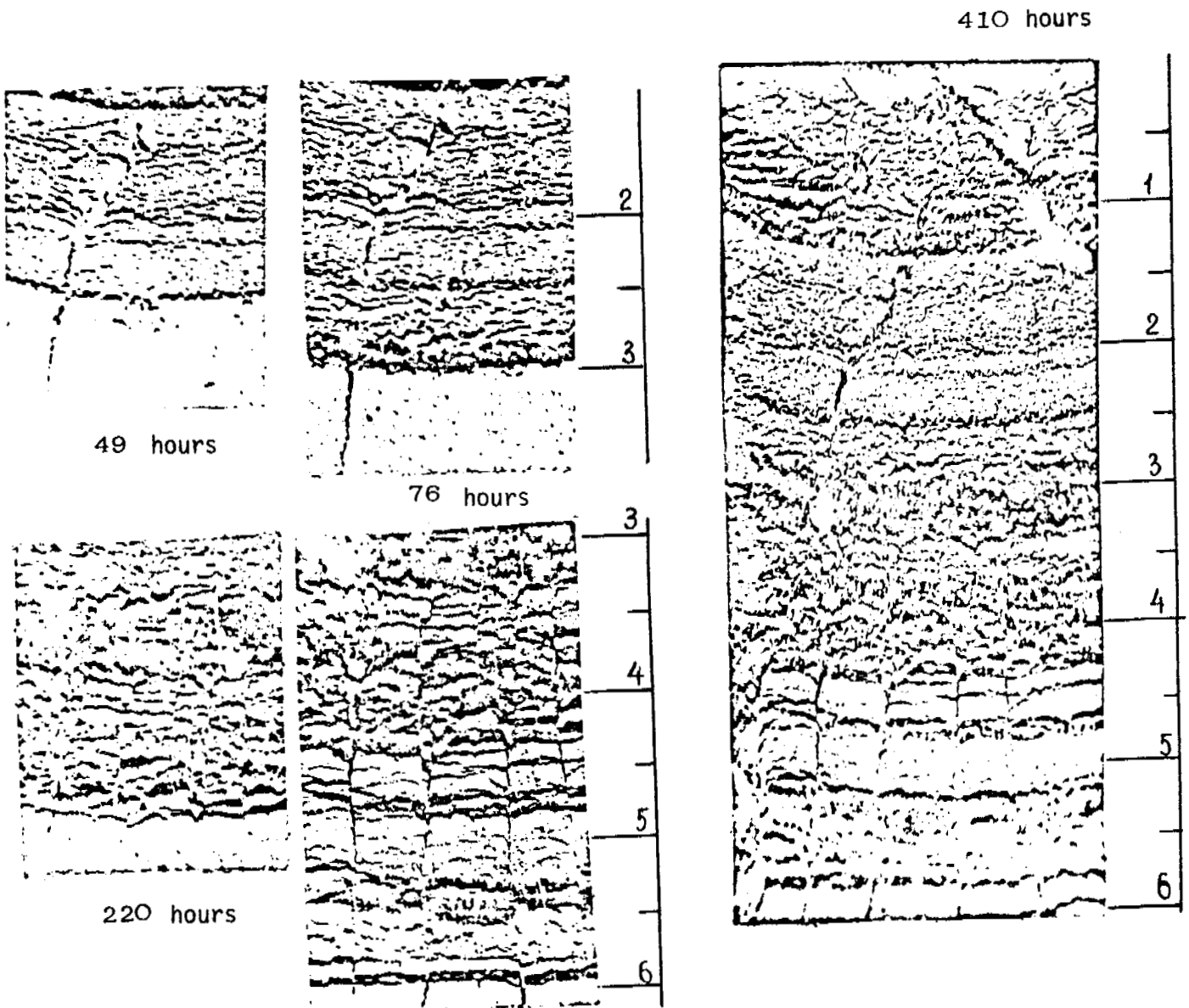

Dynamics of cryogenic structures in the process of the freezing of clays over a period of 560 hours.

distribution pattern of ice lenses in the frozen mass) is determined in homogeneous earth materials with a uniform composition by: 1) the pre-freezing structure of the unfrozen layer of earth material dehydrated by migration and adjoining the freezing boundary, i.e., the structure developing before the initiation of freezing in that layer. This structure is determined by the moisture content and temperature (rate of cooling) of that

layer at the time when it begins to freeze. The unfrozen earth material is broken up by the cracks arising in the process of its desiccation as a result of the migration of moisture into the superjacent horizons that are in the process of freezing, and because of the changes occurring in the volume of that material during its compaction and cooling; 2) the texture of the earth material developing in the process of its freezing. In this case the freezing earth material cracks up as a result of the splitting action of ice or fracturing action of the water freezing in its interstices because of dehydration of the already frozen earth material, or on account of physico-chemical processes.

The types of cracks listed above reveal the following distinctive features in the frozen and unfrozen zone respectively. The cracks recorded in the unfrozen zone are: 1) vertical, perpendicular to isothermal surfaces. These cracks arise from within in moist unfrozen soil or rock in the event of a drastic drop in the surface temperature. They may close up during the subsequent transition of the unfrozen ground to the frozen state. The ice, which fills vertical cracks only partly, has a complex ablimation\*-segregation genesis; 2) horizontal, parallel to isothermal surfaces. Horizontal cracks arise in the event of the dehydration of earth materials under conditions of a slow cooling of the unfrozen layer. During the transition of the earth materials to the frozen state some of these cracks fill with ice (mainly of the segregated type) forming layered cryogenic structures, while others close up and coalesce; 3) partings or sets of intersecting joints producing hexagonal forms in the plan. These joints arise in the event of desiccation or sharp cooling of the earth material. During the freezing they fill with ice forming a thin ice mesh bounding mineral partings represented by aggregates with the lateral surface measuring up to 1 cm.

In the process of the experiment the complex cryogenic structure alters in the 3 - 5 cm interval (Figure 3). The increase in the thickness of horizontal lenses and the accumulation of ice in the vertical cracks during the slow advance of the crystallization front lead to the disintegration of the system of vertical blocks.



In the freezing zone there form diagonal cracks disposed at an angle to the freezing boundary, and cracks perpendicular to the freezing boundary.

It has been established that regardless of the type of the cryogenic structures forming in the profile, the factor contributing to the development of large ice lenses is the deceleration of the advance of the freezing front. The most favourable conditions for the growth of ice lenses arise when the temperature of the sample surface changes in the course of the experiment, particularly in the event of a rise in that temperature (Zhestkova, 1966; Zhestkova, Guzhov, 1976). The growth of ice lenses occurs mainly in the zone of the earth material adjoining the freezing boundary on the side of the frozen soil or rock. The ice lenses inside the frozen zone undergo significant alterations on account of the migration of unfrozen water in the event of a change in thermodynamic conditions.

A "chromatic zone" or a layer of desiccated earth material has been recorded below the boundary of ice formation. In the process of freezing this zone moves downwards together with the boundary of ice formation. A drop in the rate of advance of the freezing front causes the chromatic zone to increase in thickness.

In the process of formation and growth of an ice lens, mineral aggregates break off the underlying ground and slowly become displaced or are forced out by ice. The mean rate of displacement of mineral aggregates within an ice layer was 0.5 mm a day. A drop in temperature leads to an increase in the size of the aggregates broken off the underlying ground by ice; to pollution of the ice lens and to fragmentation of the contact zones (ice-ground); and to an increase in the rate of displacement of the soil or rock aggregates. A rise in the temperature of the soil or rock (within the range of its negative values) leads to a decrease in the size of the aggregates broken off the underlying ground by ice, or even to discontinuation of the breaking-off process and to accretion of pure ice; to purification of the ice layer, and to fragmentation and dispersal of the particles, in the course of which the aggregates broken off the underlying ground only partially, return to the places from which they were dislodged,

and "settle" there once again; lastly, it causes the displacement of the soil or rock aggregates to slow down.

Whatever the type of the cryogenic structure of an ice-saturated soil or rock layer, its chances of becoming converted to an ice layer sustained along the strike are the greater, the higher its ice content during the period of its formation.

Observations on the changes in the size of the sample during the tests have shown that the total increase in the volume of the earth material is a continuous process occurring throughout the duration of the test. The absence of pauses in the heaving process during the freezing of earth materials varying in composition, evidences simultaneous concurrent growth of several ice lenses.

#### THE EFFECT OF THE PRIMARY STRUCTURE AND TEXTURE

Cryogenic structures and textures of the earth material from an undisturbed sample were compared to those of a sample with specified primary cracks. The tests were conducted with the view of elucidating the effect of the structure and texture of a soil or rock prior to freezing on the formation of inherited cryogenic structures (Popov, 1967).

Soil columns with specified primary textures were prepared from layers of earth material characterized by a homogeneous composition, equal and constant moisture content and density within each soil layer 3 - 4 cm in thickness, as well as from layers of earth materials differing in composition. The soil layers inside the column were separated by closed, partly closed or open cracks varying in size and in orientation (trend) relative to the cooling surface of the sample. In some of the columns the cracks (cavities) between the adjacent layers were left vacant, while in others they were filled with washed quartz sand (Zhestkova, 1976). Samples of earth materials with layered, reticulate or composite primary textures were prepared in this manner.

In the samples of homogeneous earth materials with closed cracks and in control samples there form cryogenic structures of the same type.

Closed cracks may not even fill with ice. Their presence in the soil or rock profile therefore commonly is not reflected in its cryogenic structure and texture. On the other hand in the samples composed of layers of earth materials varying in moisture content and density, as well as in the columns consisting of loam and clay layers differing in composition, large ice veins form in the closed primary cracks at the contact of the soil or rock layers (Figure 4). Freezing of the samples of earth material with partly closed vertical or horizontal cracks is accompanied by filling of these cracks with segregated ice; partially closed cracks with a diagonal trend have been observed in the profiles of frozen earth materials only in the form of dotted lines in isolated segments of the frozen mass. After the sample has thawed out, the cracks fill with earth material. Should the sample be refrozen, its cryogenic structural pattern therefore commonly fails to reflect that primary structure.

Figure 4

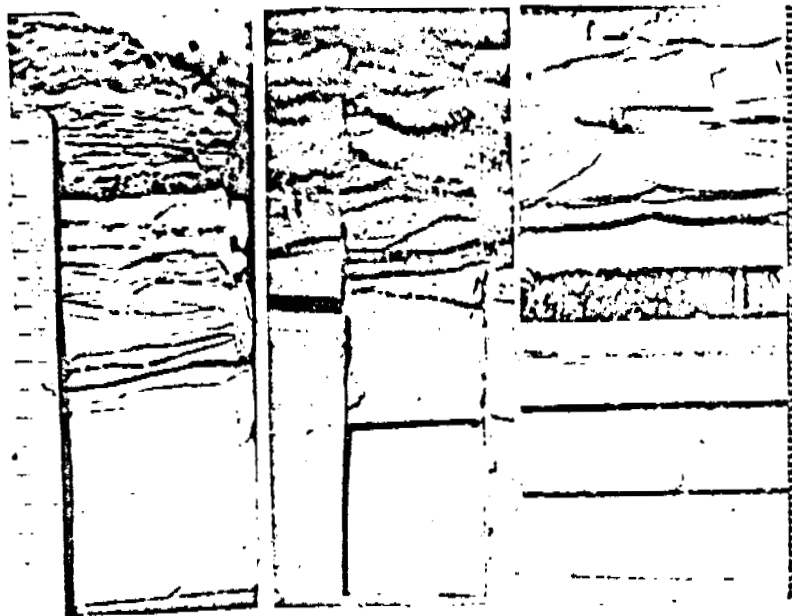

Cryogenic structures in soil samples with different primary structures and textures.

Layered cryogenic structure with ice veins sustained along the strike and measuring 0.3 - 0.5 cm in thickness, is the only type of structure forming in layered samples of soil material with open hollow horizontal cracks measuring 0.1 cm (Figure 4). The ice is confined to the primary

cracks and appears to straighten out the freezing boundary-line as a result of which an "ideal" structure of the layered type develops in the profile. In the presence within a soil or rock sample of vertical and diagonal cracks measuring less than 0.1 cm, ice veins develop precisely inside these cracks, in view of which the cryogenic structural pattern generally recapitulates the structure of the earth material prior to its freezing. Their presence in the frozen mass reduces the degree of jointing of the earth material below the freezing front during the desiccation. During the freezing of earth materials with open horizontal or vertical cracks, these cracks not only fill with ice, but change in size and shape, as well as with regard to their disposition in the frozen mass versus their original position. In the samples with diagonal cracks freezing is accompanied by a thorough rearrangement of the initial texture of the sample with prevalent development in the frozen mass of segregated ice lenses parallel to isothermal surfaces. These ice lenses intersect the layers developing in primary diagonal cracks, which leads to the formation of mixed or disorderly cryogenic structures. The primary horizontal layering of the earth material predetermines the development of layered cryogenic structures within the frozen mass and makes the formation of cryogenic nets less probably. Primary texture of the earth material predetermines the morphology of desiccation cracks in the unfrozen layer below the freezing boundary; primary cracks denoting the areas of slackening in unfrozen soil or rock, reduce the possibility of its cracking up during the dehydration.

The effect of the primary structure and texture on the structure of a sample represented by an earth material with specified diagonal and vertical cracks filled with ice, is considerably less marked if that material was thawed out, then refrozen. When soil columns with horizontal cracks are refrozen, ice lenses develop inside the same cracks and may even be thicker than at the time of the initial freezing.

Small lenses of segregated ice develop in the frozen zone of the samples with open horizontal cracks measuring over 0.2 cm. The lenses form finely layered reticulate or incompletely reticulate cryogenic structures and large ice inclusions of a complicated genesis. They fill the partings specified between the soil layers. Dynamics of the filling of these joints

with ice is described in Zhestkova's work (1976). Crystals of ablimation\* ice which fill the open cavity while the sample is in the process of freezing, "adgrow" to the underlying ground. From that moment on the cracks fill with ice at a much faster rate, a circumstance attributable to changes in the mechanism of crystallization. Subsequent recharge and growth of the ice veins occur on account of pellicular moisture.

The mixed genesis of the ice filling a crack is also reflected in its texture. Ablimation ice partly filling a specified cavity, is a fragile, highly unstable substance; if left for 24 hours in a cold closet, it sublimates almost completely.

Samples with specified cracks freeze more slowly than homogeneous samples. For example, in one of the tests the freezing boundary in a homogeneous sample advanced by 4 cm while the cracks in the parallel sample were being filled with ice.

The presence in the section of a layer of dry sand is reflected in the cryogenic structure of the layers of earth material separated by it. Within each layer there develop finely layered, layered-reticulate and massive cryogenic structures. The degree of saturation of individual clay layers with ice gradually decreases with depth. In the samples with interlayers of humid sand there forms an ice crust at the contact of sand with clay. In the clay samples interspaced by a 0.3 cm-thick vertical interlayer of water-saturated sand, there also forms a thin (0.5 mm) ice crust at the contact between the sand and the clay. The moisture content of the sand decreases following the freezing. The sand turns dry and loose and its moisture content changes from 16 to 3%.

Closed, partly closed and open cracks (with a gap of less than 0.1 cm between the layers of earth material) do not obstruct the transport of moisture from the underlying horizons to the freezing front.

---

\* Ablimation - from the Russian word "ablimatsiya" refers to the formation of ice crystals sublimated directly from water vapour in an open cavity or crack in the ground. This is similar to hoarfrost. (Technical Editor)

The columns, where the layers of earth material are separated by horizontal cracks with the cavity measuring over 0.2 cm, reveal a break in the moisture content profile. An open fissure limits the access of the moisture from the underlying horizons to the freezing front. Sand interlayers measuring 0.2 cm in thickness, also impede the migration of moisture from the subjacent horizons to the freezing front. Water is transported through the sand interlayer in the form of vapour, but on a negligible scale as compared to the magnitude of the pellicular moisture transport in the homogeneous control column of earth materials. This is precisely the reason for the moisture content of the earth material underneath the sand interlayer in the unfrozen zone being close in magnitude to the initial moisture content (with a difference of 2 - 3%). A similar phenomenon, i.e., restricted movement of water through sand interlayers in layered soils freezing under the open-system regime, has been established experimentally by N.F. Poltev (1967).

#### TEXTURES OF FROZEN EARTH MATERIAL

Studies of distinctive textural-petrographic features of frozen earth materials were carried out by using integrated techniques and method of lenses in sections with an area of 2 x 2 cm (Zhestkova et al., 1976a). The studies have demonstrated that in a frozen mass with finely reticulate, reticulate or incompletely reticulate cryogenic structures, the earth material is composed of unequal sized aggregates, ice-cement and inclusions of segregated ice. Large aggregates form within the mass partial borders delineating concentrations of smaller clay aggregates. This type of annular differentiation of the earth material is often interpreted as a result of multiple repeated freezing and thaw cycles. The data available evidence that annular differentiation of the earth material may be produced not only by particles, but also by soil or rock aggregates; it may also arise under the effect and as a consequence of one single freezing.

It has been observed that in frozen earth materials with layered cryogenic structures the orientation of segregated ice crystals alters in the zone of their contact with the soil or rock.

In horizontal ice lenses measuring over 0.1 cm, the content of soil particles decreases, there appears a multitude of interstices at the contact with ice, ice crystals increase in size and change in shape.

In large interstices of fine-grained earth materials which are not completely filled with water by the time, when the freezing begins, ice crystals become disposed along the radius. This circumstance, as well as the saturation of the upper part of the interstices with ice crystals and their gradual release downwards suggest that ice crystals grow in ice lenses around the interstices along the line of the heat flux. A similar structure (probably the same type of growth, too) is also characteristics of ice from aggregates of earth materials.

In horizontal lenses ice crystals are oriented for the most part with their major axis perpendicular to the trend of the ice lens. No distinctly defined pattern has, however, been established in the orientation of the crystals forming ice layers varying in trend.

The texture of ice-cement has been observed to alter with depth in the samples with layered cryogenic structures. In the upper layers the crystals of ice-cement are acicular in shape and appear to be intergrown with the aggregates of earth material. In the central part of the frozen zone the crystals of ice-cement coalesce at isolated points forming an ice lens discontinuous along its strike.

No differences in texture have been revealed between the ice of the cement type, ice of inclusions and that from the framework ("skeleton") of the soil or rock either in homogeneous samples or in the samples with specified closed cracks.

Ice lenses from the samples with partly closed cracks are distinguished by a more orderly orientation and larger segregated ice crystals composing the lenses.

The ice filling open horizontal cracks consists of minute acicular crystals of the ablimated type and of large columnar ice crystals of the

segregated type, which are oriented with their major optical axis perpendicular to the freezing boundary.

Open vertical cracks become filled with ice only partly. We recorded here ice of two types (i.e., segregated and ablimated), as was also the case in open horizontal cracks. Acicular crystals of ablimated ice develop on the lateral walls of the cracks and grow in the direction perpendicular to their trend. Crystals of segregated ice invade vertical cracks through their lateral walls from the horizontal ice lenses occurring in the frozen mass.

#### REFERENCES

1. ZHESTKOVA T.N. Kriogennye tekstury i l'dobrazovanie v rykhlykh otlozheniyakh (Cryogenic structures and ice formation in loose deposits). Moscow, "Nauka", 165 pages, 1966.
2. ZHESTKOVA T.N. Zavisimost' l'donasyshcheniya ot nachal'noi vlazhnosti i plotnosti tonkodispersnykh gruntov (Saturation with ice as a function of the initial moisture content of fine-grained soils). V kn.: Merzlotnye issledovaniya. Issue 13, Izd-vo MGU, Moscow State University Publishing House, pp. 67-78, 1973.
3. ZHESTKOVA T.N. Vliyanie pervichnogo slozheniya grunta na ego kriogennoe stroenie (The effect of the primary texture of frozen earth materials on their cryogenic structure and texture). - "Vestn. Mosk. un-ta", Ser. geol., No. 5, pp. 102-115, 1976.
4. ZHESTKOVA T.N. K voprosu ob usloviyakh obrazovaniya l'da-tsementa (Contribution to the problems related to the conditions of formation of ice-cement). V kn.: Merzlotnye issledovaniya. Issue 16, Izd-vo MGU, Moscow State University Publishing House, pp. 47-54, 1977.
5. ZHESTKOVA T.N. and GUZHOV V.G. Eksperimental'nye dannye o dinamike kriogennykh tekstur v promerzayushchem grunte (Experimental evidence on dynamics of cryogenic structures in freezing earth materials). V kn.: Merzlotnye issledovaniya. Issue 15, Izd-vo MGU, Moscow State University Publishing House, pp. 209-215, 1976.
6. ZHESTKOVA T.N., ZABOLOTSKAYA M.I., ROGOV V.V. and GUZHOV V.G. K metodike izucheniya struktury l'da-tsementa i l'da-vklyuchenii v merzlykh gruntakh (Methods of studying the texture of ice-cement and ice inclusions in frozen earth materials). V kn.: Merzlotnye issledovaniya. Issue 16, Izd-vo MGU, Moscow State University Publishing House, pp. 145-152, 1977.



7. ZHESTKOVA T.N., MEDVEDEV A.V. and MELAMED V.G. Rezul'taty sopostavleniya laboratornogo i matematicheskogo modelirovaniya l'donakopleniya v promerzayushchikh tonkodispersnykh gruntakh (Results of the juxtaposition of laboratory and mathematical modelling of the process of ice accumulation in freezing fine-grained earth materials). V kn.: Merzlotnye issledovaniya. Issue 15, Izd-vo MGU, Moscow State University Publishing House, pp. 37-45, 1976.
8. ZHESTKOVA T.N. and SHUR Yu.L. O vlazhnosti talogo grunta na granitse promerzaniya (Moisture content of unfrozen earth materials at the freezing boundary). - "Vestn. Mosk. un-ta", Ser. geol., No. 4, pp. 69-73, 1974.
9. POLTEV N.F. Vliyanie pervichnogo slozheniya gornoj porody na ee teksturu v merzlom sostoyanii (Effect of primary textures and structures of earth materials on their structure in the frozen state). V kn.: Merzlotnye issledovaniya, Issue 6, Izd-vo MGU, Moscow State University Publishing House, pp. 246-251, 1967.
10. POPOV A.I. Merzlotnye yavleniya v zemnoi kore (kriolitologiya) (Permafrost phenomena in the earth crust (cryolithology)). Izd-vo MGU, Moscow State University Publishing House, 302 pages, 1967.

THE ROLE OF HIGHLY MINERALIZED GROUNDWATER IN THE  
COOLING OF THE LITHOSPHERE AT DEPTH

A.B. Chizhov

Moscow State University, U.S.S.R.

The phenomenon of the wide distribution of highly mineralized groundwater with subzero temperatures (subsurface kriopegs according to N.I. Tolstikhin's terminology) and their influence on the formation of geotemperature fields continues to attract the attention of researchers. The current relevancy of this problem is determined by the rapidly increasing volume of prospecting and recovery of oil, gas and hard minerals in the arctic and northern Siberia, and by the study of both the water resources and the geothermal resources of these regions. Soviet scientists N.I. Tolstikhin, P.F. Shvetsov, N.I. Obidin, V.M. Ponomarev, A.I. Efimov, P.I. Mel'nikov, Ya.V. Neizvestnov, V.T. Balobaev and others have made a great contribution to its development. The material accumulated to date permits a quantitative assessment of individual aspects of the formation of underground kriopegs and their influence on geocryological and geothermal conditions.

P.F. Shvetsov (1941), was one of the first to draw attention to the role of highly mineralized groundwater in the cooling of the lithosphere in polar regions. This role is confirmed by the following data on the depth of occurrence of the lower limit of the kriopeg boundary ( $0^{\circ}$  geoisotherm). Thus, if within the Markhinskaya Trough, the depth of occurrence of the  $0^{\circ}$  geoisotherm reaches 1500 m (Mel'nikov, 1967), then in the very same latitude in the Vilyui syncline and the Predverkhoyansk Trough, where the permafrost is underlain by weakly mineralized waters, the thickness of the permafrost zone does not exceed 600-700 m on average. Within the Botuobinsk Uplift (area around the town of Mirnyi), the thickness of the permafrost zone including the kriopegs is 500-600 m (Efimov, 1964, Chizhov, 1968), and within the neighbouring Yakutsk artesian basin containing weakly mineralized subpermafrost water it is 200-300 m.

The mechanics of the cooling influence of the kriopegs can be explained as follows:

- 1) by free convection under the effect of a density gradient (Klimovskii, Ustinova, 1962);
- 2) by forced convection during movement of cold, highly mineralized water of the near surface horizons when there is subsidence of strata deep within the earth materials (Mel'nikov, 1967);
- 3) by reduction of heat loss during phase transformation in materials saturated with highly mineralized water.

Free convection. According to well known concepts (Tolstikhin, 1941), there are two subzones in the vertical section of the permafrost: permafrost formed during the freezing of fresh and saline groundwater; and highly mineralized subzero groundwater (kriopegs). By direct observation and generalization of data on temperatures and mineralization of kriopegs, the author established the presence, in certain circumstances, of a third intermediate zone, which is comprised of both ice inclusions and kriopegs (Chizhov, 1968). Ice formation in the horizon with highly mineralized water is accompanied by an increase in concentration and density of the latter. Thus, the convective cooling of materials is indirectly associated with the formation of an intermediate subzone, in which there is freezing out and cryogenic concentrating of subsurface solutions.

For the purposes of analytical research on the role of free convection in the formation of the permafrost zone and the cooling of the lithosphere, we will depict a rock mass in the form of monolithic blocks, divided by vertical fissures containing highly mineralized water. Convection currents could only occur in the fissures; they would not be present in the weakly mineralized blocks. An indicator of the thermal effect of convection is the change in effective conductivity of a liquid  $\lambda^3$  and the coefficient of convection  $\epsilon_k = \lambda^3 / \lambda$ , where  $\lambda$  is the true coefficient of thermal conductivity of the liquid.

From the theory of heat exchange (Lykov, 1972), it follows that  $\epsilon_k = f(\text{GrPr})$ , where  $\text{Gr} = g\beta\Delta t l^3 / \nu^2$  (Grashof's criteria),  $\text{Pr} = \nu/a$  (Prandtl's criteria), where  $g$  is the acceleration due to gravity,  $l$  is the distance between the walls of the fissures,  $\Delta t$  is the difference in temperatures between the lower and upper limits of the layer being researched,  $\nu$  is the kinematic viscosity,  $a$  is the coefficient of thermal diffusivity, and  $\beta$  is the coefficient of volume expansion of the liquid. In connection with the freezing solutions of electrolytes, a value is determined according to the relationship between the temperature of the freezing solution and its density (the latter is a function of the concentration). For a sodium chloride solution in the diapazone of subzero temperatures (actual temperatures for underground kriopegs), the value  $\beta$  is equal to  $9.7 \times 10^{-3}$ .

Free convection in a fissure takes place when  $\text{GrPr} > 1000$  and when  $10^3 < \text{GrPr} < 10^6$   $\epsilon_k = 0.105(\text{GrPr})^{0.3}$  (Lykov, 1972). As indicated by the calculations, for a fissure 0.5 cm wide, the effective thermal conductivity of the highly mineralized waters in the fissure will be approximately 4 times greater than the molecular thermal conductivity ( $\epsilon_k \approx 4$ ).

The root mean square value of the thermal conductivity of the rock mass can be found from the expression:  $\lambda_{eM} = \lambda_e N + \lambda_p (1 - N)$ , where  $\lambda_p$  is the thermal conductivity of the rock,  $N$  is the void coefficient of the fissure, which is equal to the relationship of the area of the fissure and the area of the rock mass. Obviously, the cooling influence of free convection will increase with the size of the fissure, the void coefficient of the fissure, and the ratio of  $\lambda_e$  to  $\lambda_p$ . The most favourably conditions are found in carbonaceous rock masses where the fissures have been widened by karst processes.

Calculations show that convection currents which form during freezing out of highly mineralized water further appreciably the cooling of the lithosphere for a fissure width of 0.8 to 1 or more centimetres and a coefficient of the fissured state of no less than 5%. Under field conditions of freezing, due to periodic changes in surface temperatures, the thickness of the permafrost zone with regard to this factor can exceed the "normal"

value by 1.3 to 1.5, and in the thick areas of faults with a fissure gap of 1.5 to 2 cm, it can be twice as much. There is virtually no possibility of free convection currents occurring in fissured rocks saturated with highly mineralized water due to temperature gradient only, without the participation of cryogenic concentration.

Reduction of heat loss during the freezing of water in rocks saturated with highly mineralized water. The influence of heat from the formation of ice at the depth where rock freezes under conditions of periodic fluctuations in surface temperatures has been researched by V.A. Kudryavtsev and V.G. Melamed (1966). It was shown that a reduction in the latent heat of phase transition during the freezing of  $1 \text{ m}^3$  of rock  $Q_{\phi}$  leads to an increase in the depth of perennial freezing; this will, more or less, be the value of the geothermal gradient. A fourfold reduction  $Q_{\phi}$  in rock with highly mineralized water leads to an approximate twofold increase in depth of the  $0^{\circ}$  geoisotherm when the geothermal gradient is zero and at most 30, and 10% when the geothermal gradient is 0.01 and 0.02 deg/m.

There is a complex relationship between the influence of free convection and the reduction  $Q_{\phi}$  on the depth of the permafrost zone. When there is no ice formation, which happens when the temperature of the rocks is higher than the freezing point of the solution, free convection does not occur and the geothermic gradient is close to normal: 0.2 deg/m for the sedimentary cover of the Russian Platform and 0.034 deg/m in the Epihercinian folds. When there is freezing of krioegs, development of free convection involves a decrease in the geothermal gradient and consequently an increase in the effect of the reduction  $Q_{\phi}$  at the depth of cooling in the lithosphere. Abnormally low values for the geothermal gradient in the zone of krioeg development (0.01 to 0.005 dge/m and less) is supported by observation in the field. When both factors are active, this can lead to the permafrost depth increasing 2 to 2.5 times, and, in very favourable conditions, 3 times.

Forced convection. The cooling influence brought about by the movement of krioegs when strata deep in the lithosphere sink is relatively negligible. This is due to the extremely slow filtration and the dip of the strata which, in the sedimentary cover of the platform, are measured in

fractions of a degree. Rough estimates of the hydrothermic effect of kriopeg filtration in a homogeneous stratum under the conditions of the platform, by the method of G.A. Cheremenskii (1972), show that a change in the geothermal gradient subject to this factor is less than 10%.

As with the perennial freezing of rocks containing fresh groundwater, the formation of kriopegs is mainly associated with the periodic fluctuations of temperatures at the earth's surface, and, less frequently, with sporadic changes, as for example, in the case of marine regression. A location close to the occurrence of highly mineralized groundwater furthers deep cooling of the lithosphere. In this case, if on account of specific thermodynamic conditions no intermediate subzone forms, the cooling effect is reduced considerably. When an intermediate subzone is present, the temperature fluctuations within it intensify the convective heat exchange and this leads to kriopegs penetrating deep into the rock.

The formation of a thick kriopeg zone can impede the upward movement of subsurface brines towards the surface from the deep, warmed horizons. Thus, at the boundary of the southern slope of the Anabar anticline with the Angara-Lena Depression, a sharp increase in depth of occurrence of the base of the kriopegs of from 500-600 m to 100-150 m can be observed; this is associated with the upward movement of the groundwater through the fissure zones deep below the Angara-Lena Depression. A reduction in the thickness of the kriopegs also results from the activation of water exchange under the effect of positive neotectonic movements which are accompanied by a deepening of the trench. In the basin of the River Vilyui (Botuobinskoe Uplift) the filtration speeds of the kriopegs, according to the data of V.E. Afanasenko and the author, attain 30-60 cm/yr. There is a noticeable reduction in the depth of occurrence of the lower limit near the drainage points at 100-200 m. The influence of the neotectonic uplifts within the water area of the Arctic Ocean is of a different character: the sharp reduction in surface temperature as water emerges from below sea level cause intense freezing of rocks and formation of kriopegs.

Great negative geothermal anomalies of the earth's crust, the study of which presents an important geophysical, geological and geothermic problem, are associated with kriopegs. Some aspects of the problem have been

dealt with in this paper. It must be emphasized that discharge and hot springs caused by specific reactions (including formation and destruction of crystalline hydrates of underground gases), can also display this same influence on the thickness and the temperature regime of the zone of highly mineralized groundwater.

#### REFERENCES

1. EFIMOV, A.I. Temperatura mnogoletnemerzlykh porod v okrestnostyakh g. Mirnogo. (Temperature of permafrost in the vicinity of the town of Mirnyi). In the book: **Sovremennyye voprosy regional'noi geokriologii (merzlotovedeniya)**. (Current questions on regional and engineering geocryology (Permafrost)). M., "Nauka", pp. 63-83, 1964.
2. KUDRYAVTSEV, V.I. and MELAMED, V.G. Formula rascheta glubin mnogoletnego promerzaniya i ottaivaniya tolshch gornyykh porod. (Formula for calculating depths of perennial freezing and thawing of permafrost). - In the book: **Merzlotnye issledovaniya, vyp. 6.** (Permafrost Research, No. 6). Izd-vo MGU, pp. 10-14, 1966.
3. KLIMOVSKII, I.V. and USTINOVA, Z.G. Ob osobennostyakh temperaturnogo rezhima mnogoletnemerzlykh porod raiona kimberlitovoi trubki Udachnaya. (Peculiarities of the temperature region of the permafrost in the Udachnaya Kimberlite Pipe). In the book: **Mноголетнemerzlye porody i soputstvuyushchie im yavleniya na territorii Yakutskoi ASSR.** (Permafrost and its accompanying phenomena in the Yakut A.S.S.R.). M., Izd-vo AN SSSR pp. 96-106, 1962.
4. LYKOV, A.V. Teplomassoobmen. (Heatmass Exchange). "Energiya", p. 560, 1972.
5. MEL'NIKOV, P.I. Vliyanie podzemnykh vod na glubokoe okhlazhdenie zony zemnoi kory. (Influence of groundwater on the deep cooling of the upper zone of the Earth's crust). - In the book: **Merzlotno-gidrologicheskie i gidrogeotermicheskie issledovaniya na Vostoke SSSR.** (Permafrost-hydrogeological and hydrogeothermal Research in the East of the U.S.S.R.). "Nauka" pp. 24-29, 1967
6. CHEREMENSKII, G.A. Geotermiya. (Geothermal studies). L., "Nedra", p. 271, 1972.
7. CHIZHOV, A.B. O roli vzaimodeistviya mnogoletnemerzlykh porod i podzemnykh vod v formirovanii merzlotno-gidrologicheskikh uslovii (na primere Zapadnoi Yakutii). Role of the interaction of permafrost and groundwater in the formation of permafrost-hydrogeological conditions (using the example of Western Yakutia). - In the book: **Merzlotnye issledovaniya, vyp. 8.** (Permafrost Research, No. 8). Izd-vo MGU pp. 111-122, 1968.
8. SHVETSOV, P.F. K voprosu o svyazi temperatury i moshchnosti vechnoi merzloty s geologicheskimi i gidrogeologicheskimi faktorami. (The connection between temperature and thickness of permafrost and the geological and hydrogeological factors). **Izv. AN SSSR. Ser. geolog., No. 2, pp. 114-124, 1941.**
9. TOLSTIKHIN, N.I. Podzemnye vody merzloi zony litosfery. (Groundwater of the permafrost zone of the lithosphere). M. -L., Gosgeolizdat. p. 201, 1941.

EXPERIMENTAL INVESTIGATION OF HEAT AND MOISTURE TRANSFER DURING SUBLIMATION -  
DESUBLIMATION OF WATER IN FINE-GRAINED SOILS

E.D. Ershov, V.V. Gurov, I.A. Komarov and E.Z. Kuchukov  
Moscow State University, U.S.S.R.

The problem of the sublimation of ice in fine-grained soils and the desublimation of water vapour on subsoil surfaces involves a complex set of processes and phenomena such as the phase transformation of moisture and its transfer to frozen subsoils, the heat and moisture exchange of the subsoil with the surrounding vapour-gas medium, the structural-mechanical and rheological transformation of the subsoils in the course of their freeze-drying and wetting, etc. On the one hand this results in a definite scientific and practical interest in the study of the problem; on the other hand it produces familiar methodological and technical difficulties in the setting-up and conducting of experimental investigations.

On the scientific plane, a study of the processes of sublimation and desublimation of the moisture in fine-grained soils is needed in order to explain the mechanism of the phase conversions from ice to vapour to ice, the characteristics of the external and internal heat exchanges in frozen soils, and in order to develop a methodology for investigating the processes of heat and moisture transfer that complicate the phase transformations of water, etc. The process of sublimation of ice is not only a subject of investigation, but constitutes a universal method of studying the structure and properties of ice, frozen soils and capillary-porous bodies. The processes of freeze-drying of subsoils and the crystallization of water vapour on subsoil surfaces acquire considerable current importance also for practical tasks in connection with the planning, construction and exploitation of large underground engineering works for various purposes, the walls of which are made up of frozen, fine-grained soils. An account of the



processes of heat and moisture transfer during the sublimation and desublimation of moisture in fine-grained soils is also needed for the quantitative appraisal and prognostication of the thicknesses and extents of glaciers and of annual fields of icing, the sealed-in humidity regime of soils, subsoils and road surfaces, and for solving a number of problems in permafrost science, climatology, etc.

#### APPARATUS AND METHODOLOGY OF INVESTIGATION

In 1970, complex experimental investigations of the processes of sublimation and desublimation of moisture in fine-grained soils were begun in the Permafrost Studies Department of Moscow State University under the guidance of Professor V.A. Kudryavtsev, and have continued into the present year.

For studying the processes of heat and moisture transfer in fine-grained soils on the sublimation of ice two laboratory set-ups were designed. The main parts of these are an air thermostat operating in the negative range of temperatures, a sublimation chamber with specimens of the soils under investigation, an electric fan, and a block unit for registering and controlling the operating regime of the apparatus. The novelty of the apparatuses consists in the fact that in one of them the sublimation of the ice is realized in the atmospheric medium at atmospheric pressure, while the second one permits investigation of the influence of high pressure and high molecular weight of gases on the process of ice sublimation in fine-grained soils. The sublimation chamber of the latter equipment consists of a thick-walled, cylindrical vessel fitted with a system for feeding in cold-compressed gases.

The soil specimens were either cylindrical or rectangular parallelepipeds 8 to 10 cm high with cross-sectional areas of 12 - 15 cm<sup>2</sup>. The temperature profile at the soil sampling level was measured with the aid of copper-constantan thermocouples, the working junctions of which were placed at regular intervals of 1 cm along the vertical axis of symmetry of the control specimens. The lateral surface and lower base of each subsoil specimen was sealed off hermetically by means of transparent cassettes

(polyethylene or organic glass), and evaporation of the subsoil moisture took place through the open upper bases. In this way uniform measurement and visualization of the process of freeze-drying of the subsoils were achieved.

Investigation of the mechanism and regularities of the water vapour desublimation process at subsoil surfaces was carried out in a third apparatus, the basic difference from those described above consisting in the creating of a controlled gradient of negative temperatures between the upper and lower surfaces of soil specimens. The temperature on the lower base of the specimen was produced and kept constant with the aid of a metallic stamp connected to a supplementary liquid thermostat. The crystallization of water vapours was realized in the atmospheric medium at atmospheric pressure. The height of the soil specimen was 3 cm.

Each apparatus constituted a closed, thermally insulated system permitting the conducting of prolonged tests at temperatures  $T = 253 - 273^{\circ}\text{K}$ , at air (gas) flow velocities over the soil specimens of  $V = 0 - 20$  m/sec, and at relative humidities of  $\phi = 50 - 95\%$ . The creation of a uniform  $T, V, \phi$  profile in specimens immersed in flowing air was realized by the hydrodynamic air-flow stabilization section. The  $T, V, \phi$  control accuracies of the equipment were  $0.1^{\circ}\text{K}$ ;  $0.1$  m/sec and  $1\%$ , respectively.

The main unknown characteristics of the processes being studied are the intensity of sublimation and desublimation (density of flow of water vapour evaporating or condensing on the open surfaces of the subsoil specimens), the rate of descent of the drying zone and the growth of the crystallizing snow layer, the temperature and moisture profile in the subsoil specimens and their measurement as a function of time and of the constitution, structure and properties of the subsoils. The methodology of preparing subsoil specimens, and of conducting experiments and processing the experimental data, the description and diagrams of apparatus, as well as the composition, structure and properties of the fine-grained soils under investigation are given elsewhere (Ershov, Gurov, 1972; Ershov et al., 1975).

HEAT AND MOISTURE TRANSFER DURING SUBLIMATION OF ICE  
IN FINE-GRAINED SOILS

The mechanism of freeze-drying of fine-grained soils is directly associated with the phase transformations of moisture as such and with the transfer of heat and moisture in subsoils. According to the hypothesis formulated elsewhere (Ershov, Gurov, 1972; Ershov et al., 1973), the sublimation of ice in fine-grained soils is not only and not just a transformation of moisture from the solid to the gaseous state, but also involves the evaporation of unfrozen water with continuous replenishing of its supplies at the expense of the ice, with which unfrozen water in the soil pores is present in a state of dynamic equilibrium in the soil pores at a given temperature and pressure. In the works referred to, it was demonstrated that in the general case the sublimation intensity of ice ( $I_s$ ) in dispersed soils is determined by two components - the moisture flows in the gaseous ( $I_v$ ) and in the liquid phase ( $I_w$ ):

$$I_s = I_v + I_w = - \left( \frac{K_v}{RT} \cdot \frac{dP}{dZ} + K_w \cdot \gamma_0 \frac{dW}{dZ} \right), \quad (1)$$

In coarse-grained soils however, the second component is practically non-existent. In equation (1)  $K_v$  and  $K_w$  are vapour diffusion and liquid water diffusion coefficients, respectively,  $R$  is the gas constant,  $P$  the water vapour pressure,  $W$  the subsoil moisture per unit weight,  $\gamma_0$  the weight of the subsoil skeleton per unit volume.

The mechanism of migration of unfrozen water and of vapour transfer is determined by the thermodynamic conditions of interaction between the soil and surrounding medium, the character and energy of the bonding of moisture with the mineral skeleton of the subsoil and the characteristics of its structure. It must be emphasized that a transfer of water in the liquid phase in the zone of drying of very fine-grained subsoils is greater in the region of intensive phase transformations, i.e., at relatively high negative temperatures. At low temperatures ( $T < 260^{\circ}\text{K}$ ) and in coarse-grained subsoils the amount of unfrozen water is negligible and the sublimation intensity of the ice is determined by diffuse vapour transfer, to which there is less

resistance in coarse-grained (arenaceous) than in fine-grained (clayey) ones. According to our figures, at  $T = 268^{\circ}\text{K}$  and at atmospheric pressure in gravels of various fractions  $K_V = (7 - 11) \cdot 10^{-6} \text{ m}^2/\text{s}$  and in the clays of  $K_V = (2 - 4) \cdot 10^{-6} \text{ m}^2/\text{s}$  and in the clays of  $K_V = (2 - 4) \cdot 10^{-6} \text{ m}^2/\text{s}$ ,  $K_W = (2 - 4.5) \cdot 10^{-10} \text{ m}^2/\text{s}$ . When the temperature increases and the external pressure decreases,  $K_V$  increases, and  $K_W$  increases with increasing  $T$  and  $W$  of the subsoils. By virtue of the relatively small moisture and heat transfer coefficients with the subsoil compared with the corresponding external exchange coefficients, the intensity of the freeze-drying process is restricted by the internal heat and moisture transfer. Here the transfer of moisture plays a determining and limiting role in the transfer processes, since with the input of heat by conduction and convection to the zone of phase transformations, the diffusion resistance to moisture transfer in both phases is considerably greater than the equivalent thermal resistance. Since the freeze-drying is not intense (Ershov, Gurov, 1972) and the temperature gradient occurring in the subsoil is small ( $\sim 5^{\circ}\text{K/m}$ ), it may be assumed in first approximation that the process of ice sublimation in fine-grained subsoils takes place under quasi-isometric conditions. This greatly simplifies the solution to the problem of heat and moisture transfer during the freeze-drying of rocks, since the moisture transfer problem can be formulated and solved independently of the heat transfer problem.

Regularities of heat transfer in subsoils. Since both the absolute values and the gradients of temperature involved in the freeze-drying of subsoils are negligible, we neglect the exchange of heat in the subsoil pores by radiation and convection, in comparison with heat transfer by thermal conduction. Experimental data from the study of the dynamics of the temperature field in subsoils have shown that the profiles of temperatures of dried and frozen layers (unaffected by the process of ice sublimation) are almost linear. At the mobile boundary separating the subsoil layers (in the zone of moisture phase transformations) they lose the salient point produced by the difference of thermophysical characteristics of the subsoil, and also by the presence here of the flow of heat. In this case the heat balance equation at the mobile boundary can be written in the following form:

$$-\lambda_{dr} \cdot \left( \frac{dT}{dz} \right)_{dr} + l_s \cdot r = -\lambda_f \cdot \left( \frac{dT}{dz} \right)_f, \quad (2)$$

where  $\lambda_{dr}$ ,  $\lambda_f$  are coefficients of heat conductivity of the subsoil in dry and frozen layers, respectively, and  $r$  is the latent heat of sublimation of ice.

Analysis of the experimental data has shown that the intensity of the flow of heat in the frozen layer  $q_f$  decreases in the course of time, while in the dried layer  $q_{dr}$  it remains practically constant. The constant character of  $q_{dr}$  leads to the conclusion that in the process of ice sublimation, it follows from equation (2) that the value of  $q_f$  is determined and limited by the intensity of ice sublimation (the change of  $r(T)$  in the temperature interval under consideration can be neglected).

When the rate of flow of air was increased, the values of  $q_f$  and  $q_{dr}$  increased at a faster rate (1.5 - 2 times) in the range 2 - 10 m/s, but the difference between them continued to correspond to the expenditure of heat in phase transformations. Lowering the temperature decreases the value of  $q_f$ , but the value  $q_{dr}$  remains practically constant. For specimens of polymineral clay and loam the decrease of  $q_f$  is 10 - 15 watts/m when  $T$  decreases from 271 to 260<sup>0</sup>K. The absence of a marked air temperature effect on the value of  $q_{dr}$  and the coefficient of heat exchange, is apparently associated with the negligible change in thermal conductivity and with the viscosity and other physical characteristics of the air in the temperature interval under investigation. The rate of flow of the air has a substantial effect on the thickness of the boundary layer, leading to a change in the resistance to heat transfer in it.

#### Regularities of moisture transfer during the freeze-drying of soils.

The characteristics of the moisture profile in fine-grained soils and its dynamics during freeze-drying, and also the influence of the velocity, temperature and relative humidity of the air flow on the intensity of the sublimation of ice in subsoils and the mobility of the sublimation zone in them were reported on at the II International Conference on Permafrost (Ershov et al., 1973). In particular, it was shown there that an increase in the velocity of the air flow of 5 m/s and a reduction in the temperature from 273 to 261<sup>0</sup>K show the greatest effect on the value of  $I$ . In the wetness profile of specimens of moisture-saturated fine-grained soils of undisturbed and disturbed structure of massive cryogenic texture, three characteristic

moisture points are noted. Further study of the physical character of the first two of these, carried out on the initiative of V.A. Kudryavtsev, enabled us to propose a new method of determining the quantity of unfrozen water in the ice of frozen fine-grained soils, based on the regularities of distribution of the total moisture content during sublimation of the ice (Kudryavtsev et al., 1976). At the present time this method, possessing a number of technical and economic advantages compared, for example, with the widely practised calorimetric method, is being introduced into practice in construction engineering explorations in areas of permafrost soil distribution, including the Baikal-Amur mainline track.

The investigation of the process of freeze-drying of rocks and "pure" ice under conditions of high pressure in a gaseous medium of different molecular composition was of definite interest. Experimental investigations were carried out with the following iner gases: helium ( $\mu = 4$ ) and argon ( $\mu = 40$ ) and with air ( $\mu = 29$ ). The choice of these as working gases was due first to the fact that the studied range of variations of their molecular weights embraced the most widespread natural gases: methane ( $\mu = 16$ ), ethane ( $\mu = 30$ ) and propane ( $\mu = 44$ ), and secondly that they are safe to handle under laboratory conditions. A study of the effect of pressure of a gaseous medium on the intensity of sublimation of ice in subsoils was carried out over a range of pressures from atmospheric to  $12 \cdot 10^5 \text{ N/m}^2$  (Figure 1).

Figure 1

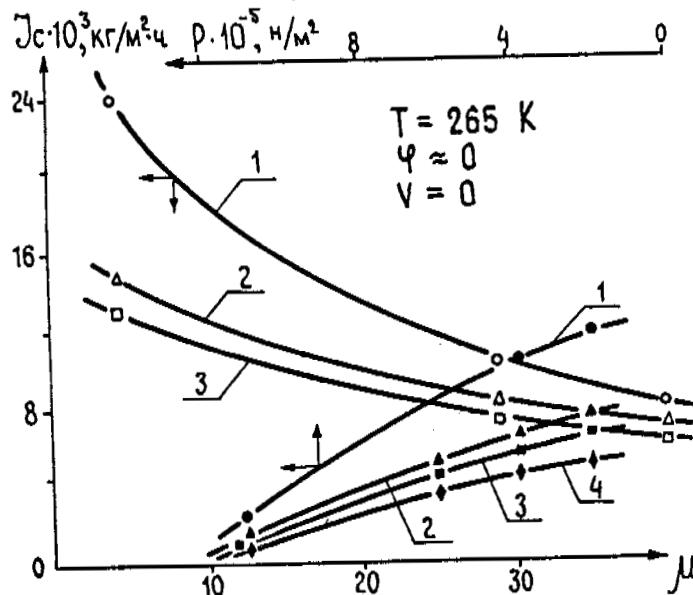

Intensity of ice sublimation in fine-grained soils as a function of the molecular composition and pressure of the gaseous medium.

1 - ice; 2 - polymineral clay; 3 - kaolinite clay; 4 - loam.

Analysis of equation (1) shows that with increasing pressure the free path length of the vapour molecules decreases with increasing pressure and hinders their diffusion, leading to a decrease in the value of  $I_s$ . The effect of  $\mu$  is also associated with a change in the coefficient of vapour diffusion  $D$ , the value of which is  $9.4 \cdot 10^{-5}$  in a helium atmosphere,  $2.2 \cdot 10^{-5}$  in air and  $2.1 \cdot 10^{-5} \text{ m}^2/\text{s}$  in argon. The molecular composition of the gas does not appear to have any effect on moisture transfer in the liquid phase. This is confirmed indirectly by the disproportionate change in the relationship between the values  $K_v$  and  $I_s$  in the helium and argon atmospheres for the finer-grained subsoils - clays (Figure 1), in which the share of the migration of unfrozen water attains considerable values.

The effect of the granulometric composition on the value of  $I_s$  becomes apparent in their specific active surface area, the amount of unfrozen water, the mean effective radius of the pores and the active porosity, and in the case of the arenaceous soils, mainly in the porosity and the effective radius of the pores. The influence of the mineral composition is determined by the nature of the crystallochemical structure of the argillaceous minerals.

The microaggregate composition of rocks in the process of their freeze-drying becomes evident in the nature and extent of the influence of the constitution of altered cations and the concentration of water-dissolved salts in the pore solution on the mobility and quantity of unfrozen water and on the structure of the pore space.

With increasing valency of the altered cations saturating the montmorillonite clays, the thickness of the films of unfrozen water increases as demonstrated in the work of A. Ananyan (1972), and this results in their greater mobility and a higher coefficient of diffusion. On the other hand, owing to very strong coagulation, there is a sharp decrease in the fineness of the clays, resulting in an increase of the mean effective radius of the pores and of the vapour transfer coefficient. Owing to the exchange of monovalent cations ( $\text{Na}^+$ ) for divalent and trivalent ones ( $\text{Ca}^{2+}$  and  $\text{Fe}^{3+}$ ) in montmorillonite clays, an increase is produced in the value of  $I_s$  (Figure 2) at the expense both of  $I_v$  and  $I_w$ . An investigation of the sublimation of ice

in kaolinite clays saturated with the same cations as the montmorillonite clays did not show any regular influence of the valency of cations on the value of  $I_s$ . The intensity of ice sublimation in soils with different concentrations of pore solution bears an extreme character. With increasing concentration of the pore solution up to the threshold of aggregation (coagulation) it decreases, reaches a minimum and after the aggregation threshold increases again (Figure 2), which is due to the corresponding change in the coefficient  $K_w$  (Ershov et al., 1975).

Figure 2

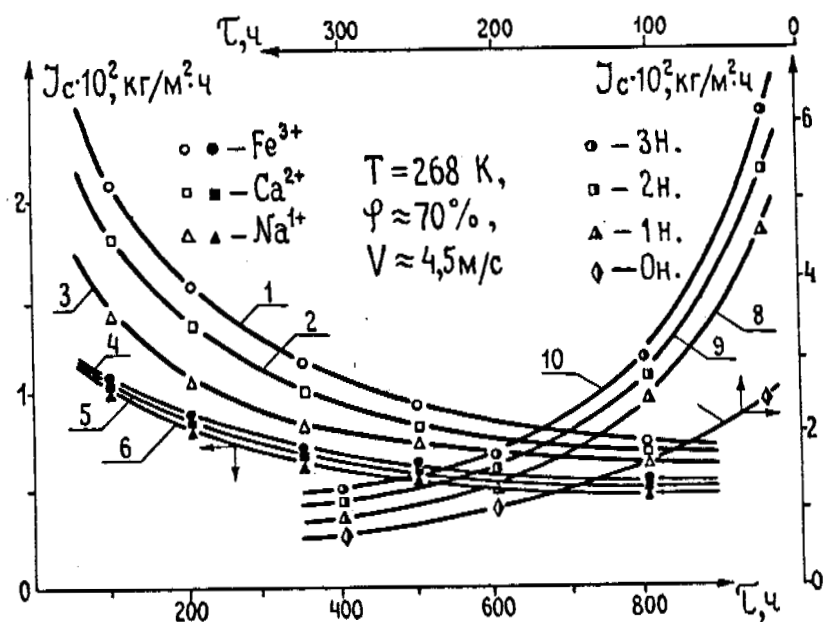

Effect of the composition of exchange cations and concentration of pore solution on the intensity of ice sublimation in fine-grained soils.

- 1 - 3 - montmorillonite clays saturated with different exchange cations;
- 4 - 6 - kaolinite clays saturated with different exchange cations;
- 7 - 10 - polymineral clay prepared in  $\text{CaCl}_2$  solutions of various concentrations.

The sublimation of ice in soils with a different degree of occupation of pores by moisture ( $q < 1$ ,  $q \approx 1$ ) leads to a specific difference in the character of the moisture profile during freeze-drying. The above contemplated regularities of moisture transfer during the freeze-drying of fine-grained soils were obtained for  $q \approx 1$ , which guarantees practically frontal drying of the soil strata. For  $q < 1$  the process of freeze-drying has a spatial character, i.e., the moisture profile possesses a drying zone



of substantial size and (this is sharply expressed for  $q \approx 1$ ) there are no areas of large and small moisture gradients on it, while for  $q < 0.7$  the boundary separating the dried layers of subsoil from those unaffected by the process of sublimation of ice is generally absent. This difference in the nature of the development of the process of freeze-drying causes a decrease in the value of  $I_s$  in moisture-unsaturated frozen soils compared with moisture-saturated ones. This is confirmed by data on the sublimation of ice in specimens of clay and sand with different levels of pore occupation by unfrozen water and ice.

A study of the influence of the inhomogeneity of fine-grained soils resulting from the alternation of layers of soil differing in granulometry and mineralogical composition, density and moisture content on the development of the process of their freeze-drying has shown that, firstly, the value of  $I_s$  in these is determined and restricted by the intensity of sublimation in the layer characterized by a decreased content of unfrozen water and, secondly, the distribution of the moisture in the dried zone of the stratified subsoil has a spasmodic character.

The study of regularities of ice sublimation in the above-considered specimens of disturbed texture, structure and properties permitted the formulation of a satisfactory explanation of the process of freeze-drying of fine-grained soils of undisturbed texture and of various origin and age. The study of the processes of heat and moisture transfer was carried out on monoliths of five genetic complexes, namely alluvial, scree, lacustrine-alluvial, glacial-marine and marine, the description and characteristics of which were given elsewhere (Ershov et al., 1975). From the analysis of the experimental data it was established that the effect of the age of soils is expressed in their solidity, while the effect of their origin is expressed in the concentration of pore solution. In younger soils (Upper Quaternary) the intensity of ice sublimation, owing to greater porosity, appeared greater than in ancient soils (Neogene). The process of ice sublimation in a given granulometric variety of soils proceeds less intensively in marine deposits than in continental deposits; the more fine-grained the subsoil, the greater this difference.

## HEAT AND MOISTURE TRANSFER IN THE COURSE OF VAPOUR DESUBLIMATION IN SOILS

Unlike the process of ice sublimation, the kinetics of which are determined by the resistance to the transfer of moisture, the intensity of desublimation  $I_d$  of water vapours on the surface of soils is determined by the exchange of heat between the vapour-air medium and the soil, i.e., it is limited by the thermal-physical properties of the interacting media and the layer of snow that forms. The crystallization of water vapour molecules on the surface of frozen soils takes place when saturation vapour pressure is reached at the air-subsoil interface at a given temperature,  $P_{sat}(T)$ .  $P_{sat}(T)$  decreases with decreasing temperature, and this favours the initiation of water vapour crystallization. In the laboratory apparatus  $P_{sat}(T)$  is attained by increasing the controlled gradient of negative temperatures between the vapour-air medium and the lower surface of the subsoil, the latter being the colder.

As investigations carried out by the replica method\* have shown, the surfaces of very fine-grained and coarsely fragmented soils are nonuniform from the energy standpoint. The process of desublimation of the first ice crystals (in the form of snow) proceeds selectively, becoming localized on the surfaces of active centres of crystallization. In very fine-grained soils these centres, evidently, are complex water molecules adsorbed on the soil surface, whereas in coarse-grained soils they are various macro- and micro-defects of the surface (splits, protuberances, etc.). The influence of the mineralogical composition of the soil is revealed in the form, size and orientation of the first ice crystals. Thus, on clays of polymineral, kaolinite and montmorillonite composition they had the idioformal appearance of hexagonal flakes 0.02 - 0.03 mm in size placed with their base surfaces flat against or at a slight angle to the surface. In quartz, most of the ice crystals are isometric flakes of 0.01 - 0.02 mm in size, while in calcite they are long "needles" sometimes growing together. The smallest ice crystals (1  $\mu$ m) are attached to surfaces of sericite, while the largest (0.1 - 0.2 mm) are found on labradorite.

---

\* The investigations by the replica method were conducted by V.V. Rogov.

After the first crystals of ice had formed, the desublimation of the vapour continued to take place on the ice crystals themselves, which united into a dense, flat layer at distances of 0.2 - 0.4 mm from the surface of the subsoil, while the flat shape of the layer remained constant throughout the entire process. As the mass of snow accumulated, a differentiated consolidation of the snow took place in the direction of lower temperatures (on the subsoil side), caused by the action of the vapour pressure gradient in the layer and the intense recrystallization of the snow. Now the large star-shaped and dendritic crystals disintegrated, acquiring a round granular shape. During the initial period the process of thermal metamorphism also proceeded more intensively (Figure 3) on specimens of ice and metal, compared with the soil specimens.

Figure 3

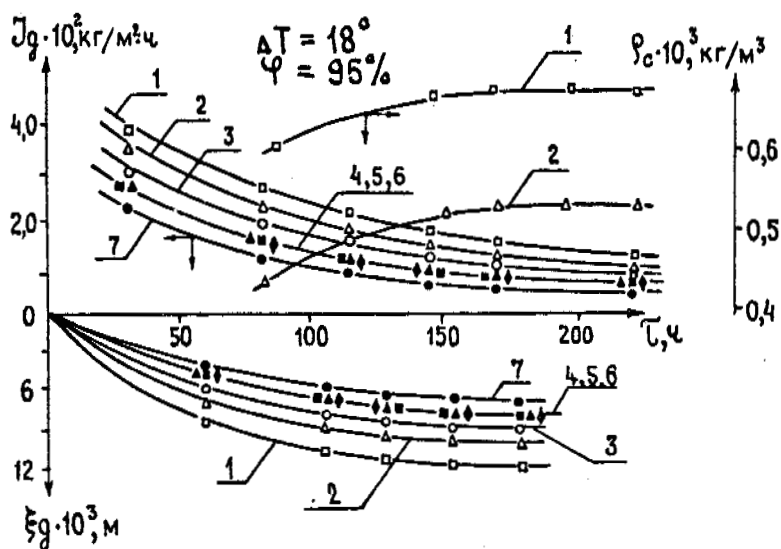

Intensity  $I_d$  of desublimation of vapours, thickness of crystallized layer,  $\xi_d$ , and its density  $\rho_c$  in various specimens, as functions of the processing time.

- 1 - metal, 2 - ice; 3 - sand saturated with water;
- 4, 5, 6 - polymineral, kaolinite and montmorillonite clays respectively; 7 - sand not saturated with water.

The value of  $I_d$  decreases with time and with decreasing temperature gradient between the "core" of the vapour-air current and the lower surface of the soil specimens, and with increasing relative humidity of

this current. Given constant parameters of the current ( $T$ ,  $V$ ,  $\phi$ ,  $\mu$ ) the difference in absolute values of  $I_d$  for different soils (Figure 3) is due mainly to the difference in the thermal conductivity coefficients of the subsoils, since redistribution of moisture in the moisture-saturated subsoils at the expense of its transfer from the snow layer in the course of the experiments was negligible (about 1% of the overall moisture balance). The value of  $I_d$  in moisture-saturated soils was considerably higher than in unsaturated ones, and has a tendency to increase with decreasing fineness of the soils. The difference in thickness  $\xi_d$  of the layer of snow forming in the soils under investigation (Figure 3) was due to a different intensity both of the vapour desublimation process in soils and of the thermal metamorphism processes of the snow.

The kinetics of the vapour desublimation process in coarse scree (the investigations were carried out on small and medium gravel and small rubble in accordance with V.V. Okhotin's classification) is determined not only by the thermal conductivity of these fragmentary rocks and their contactile thermal conductivity but also by the intensity of the heat transfer processes in the rock stratum. The experimental data show that  $I_d$  increases with increasing block size for various packings of the fragments in coarse screens.

#### FORECASTING AND MANAGEMENT OF THE PROCESSES OF SUBLIMATION AND DESUBLIMATION OF MOISTURE

The forecasting and management of the processes of sublimation and desublimation of moisture in fine-grained soils are based on the main methodological ideas on the forecasting of ground freezing and the principles of controlling freezing processes in the ground (Kudryavtsev, 1961; Kudryavtsev, Ershov, 1969). In the course of this a varied permafrost-engineering-geological survey of the construction area is being carried out side by side with the operation of engineering installations; a forecast of the development of moisture sublimation and desublimation processes is made on the basis of a structural model that takes the geological and thermal-physical situation into account in actual natural conditions; for the optimum functioning of an installation under the

projected conditions the measures required to control the processes of external and internal heat and moisture transfer in frozen subsoils, accompanied by moisture sublimation and desublimation, are indicated.

For the process of ice sublimation in fine-grained soils a structural forecast model is now being construction (Ershov et al., 1974). With its help a rough estimate is being made of the thickness of the zone that will be dried out in soils of various composition during the period of operation of an engineering installation, which can be as much as 1 m. In the event of removal of a freeze-dried soil, the subsoil mass can regress by several metres.

The methodology of controlling the processes of moisture sublimation and desublimation in subsoils has been worked out from investigations of the partial and general regularities of these processes, a knowledge of which enables us to find the needed measures to improve and alter the fundamental parameters of the processes that are studied. In this connection the current set of methods breakdown into two groups. One of these involves measures for directing the change in the parameters of the gaseous medium ( $T$ ,  $V$ ,  $\phi$ ,  $\mu$ , etc.) and the surface character of the subsoil formation. When the subsoils are covered with coatings of asphalt, latex and hydroparafin, the sublimation of ice in the subsoils is practically eliminated. The second group of methods involves the various means of controlling the processes of sublimation and desublimation of moisture by various technological and frozen-soil improvement measures. For example, previous compaction and drainage of subsoils and the application of methods of lubrication, silication, resinification, etc., greatly retard the process of sublimation and desublimation of the moisture in the subsoil. The process of sublimation can be intensified by the method of salt stabilization of subsoils. The intensity of ice sublimation in subsoils can be promoted by applying permafrost improvement, creating some type of cryogenic texture, or covering the subsoil surface with a layer of ice.

Obviously, a solution to the problem of controlling the processes of moisture sublimation and desublimation in natural conditions constitutes part of a coordinated application of both groups of methods, promoting a more

effective control of the processes of external and internal heat and mass transfer in frozen subsoils interacting with the gaseous medium.

In conclusion, we note that a major programme of investigations into the processes of moisture sublimation and desublimation in fine-grained soils, up to and including their forecasting and control, is being carried out in the Permafrost Studies Department of Moscow State University. The results so far obtained are already being applied in the practice of construction-engineering exploration and may be utilized in future for the purpose of forecasting and controlling the investigated processes.

#### REFERENCES

- ANANYAN A.A. Otsenka srednei tolshchiny plenok vody v talykh i merzlykh tonkodispersnykh gornykh porodakh. (Estimate of the mean thickness of water films in unfrozen and frozen, very fine-grained soils). In the book: Svyazannaya voda v dispersnykh sistemakh (Bound water in fine-grained systems), No. 2, Izd-vo MGU, pp. 106-114, 1972.
- ERSHOV E.D. and GUROV V.V. Massoperenos v protsesse sublimatsii l'da v dispersnykh gruntakh pri vzaimodeistvii ikh s vozdushnym potokom. (Mass transfer during the process of ice sublimation in fine-grained soils when they interact with a flow of air). In the book: Teplo- i massoperenos (Heat and mass transfer). Vol. 2, Part 2, Minsk, pp. 212-224, 1972.
- ERSHOV E.D., GUROV V.V. and DOSTOVALOV B.N. Sublimatsiya l'da v dispersnykh gruntakh razlichnogo kriogennogo stroeniya pri ikh vzaimodeistvii s vozdushnym potokom. (The sublimation of ice in fine-grained subsoils of various cryogenic structure while interacting with a flow of air). II International Conference on Permafrost. Reports and communications, No. 4, Yakt. Kh. Izd-vo, pp. 185-188, 1973.
- ERSHOV E.D., GUROV V.V., KOMAROV I.A., AKIMOV Yu.P. and KUCHUKOV E.Z. K raschetnoi skheme prognoza moroznogo issusheniya dispersnykh gornykh porod. (On a structural model to forecast the freeze-drying of fine-grained soils). In the book: Merzlotnye issledovaniya (Permafrost studies), No. 4, Izd-vo MGU, pp. 222-229, 1974.
- ERSHOV E.D., KUCHUKOV E.Z. and KOMAROV I.A. Sublimatsiya l'da v dispersnykh porodakh. (Sublimation of ice in fine-grained soils). Izd-vo MGU, 223 pages, 1975.

KUDRYAVTSEV V.A. Merzlotnaya s'ema kak osnovnoi vid merzlotnykh issledovaniy. (Permafrost surveying as a basic form of permafrost investigations). In the book: Merzlotnye issledovaniya (Permafrost studies), No. 1, Izd-vo MGU, 1961.

KUDRYAVTSEV V.A. and ERSHOV E.D. Klassifikatsionnaya skhema priemov po napravlenomu izmeneniyu merzlotnykh uslovii. (Classification scheme of methods for controlled changing of permafrost conditions). In the book: Merzlotnye issledovaniya (Permafrost studies), No. 9, Izd-vo, MGU, pp. 155-157, 1969.

KUDRYAVTSEV V.A., ERSHOV E.D., GUROV V.V., AKIMOV Yu.P., KOMAROV I.A. and KUCHUKOV E.Z. Sposob opredeleniya kolichestva nezamershei vody i l'da v gornykh porodakh. (Methods of determining the amount of unfrozen water and ice soils). Authors' statement no. 532044, - "Byulleten izobretenii", No. 38, 1976.

WATER MIGRATION, FORMATION OF TEXTURE AND ICE SEGREGATION  
IN FREEZING AND THAWING CLAYEY SOILS

E.D. Ershov, V.G. Cheverev, Yu.P. Lebedenko and L.V. Shevchenko  
Moscow State University, Faculty of Geology, U.S.S.R.

The problem of moisture migration and segregated ice formation in soils is constantly attracting the attention of large numbers of specialists. Its solution is of great practical and scientific importance in terms of the refinement of existing systems or alternatively, the origination of new systems for predicting the development of heaving and the formation of the cryogenic structures of both the seasonally frozen layer and the permafrost. In view of the highly complex nature of this problem, a whole series of questions remain to be answered. This calls for further study. They include, in particular, the mechanism and the laws governing the transfer of moisture and ice segregation in frozen, freezing and thawing soils, the distinctive features of the coagulation, dispersion and texture formation processes, the role of shrinkage, swelling and distension and also the disjoining action of thin films of water in the formation of cryogenic structures.

Experimental studies of these inadequately understood facts of the problem were conducted in an integrated manner, that is, in determining the character of the change in the basic parameters of heat- and mass transfer and the process of ground ice formation in freezing or thawing soils. The following were measured: the temperature  $t$ , the moisture content  $W$ , the volumetric mass of the soil skeleton  $\gamma_{sk}$ , the external and internal flows of migrating moisture, its thermodynamic potential  $\mu_w$  and the stressed and strained state of the soil. Further, the process leading to segregated lensed ice formation was continuously observed by means of microscopy, photography and time-lapse cinematography.



As the subject of the research, saturated soils of varying mineralogical and grain-size compositions were used (kaolinitic, montmorillonitic and hydromicaceous-montmorillonitic clays, clayey silts and sandy silts) the properties of which had previously been described in sufficient detail (Ershov et al. 1975).

The experiments involving unidirectional freezing and thawing of finely dispersed soil samples were conducted on a special experimental unit, using the procedure described in papers by Kudryavtsev et al., 1976 and Lebedenko, 1976. It is especially important to note that the freezing of the thawed or the thawing of the frozen samples was only partly accomplished, that is, by not more than half of their length, which ranged from 12 to 30 cm in the various experiments.

Analysis of the results of the experiments, using for this purpose microscopy, photography and cinematography, conclusively corroborates earlier evidence (Puzakov, 1960; Orlov, 1962) that the formation of segregated layers of ice occurs for the most part in the freezing zone of the soil in the below-freezing temperature range. The growth of thin ice layers at the freezing front, that is, at the boundary between the thawed and the frozen zones, can here be regarded as merely a particular case of ice segregation.

This was used as a basis for further experimental research directed towards a study of the physical mechanism, the parameters and the laws governing the development of the moisture migration process, not only in the thawed zone but more particularly in the frozen and freezing zones. Of special interest here is the character of development of the motive force of the moisture migration in freezing soils.

In the initial period of cooling, when all of the soil is still in the thawed (unfrozen) state, potential gradients of the moisture grad  $\mu_w$  and a migrational flow directed towards the cold side of the sample are absent. In some cases an oppositely directed flow of water is observed, which is indicative of the inconsequential role of the purely thermal diffusion mechanism of moisture migration towards the cooling (freezing) front in saturated soil. With the appearance of the first ice crystals and the

origination of below-freezing temperature gradients in the soil, the motive forces of the moisture migration ( $\text{grad } \mu_w$ ) associated with the increase in the unexpended surface energy of the mineral skeleton of the soil during transition of part of the bound water into ice begin to be clearly exhibited. Simultaneously, the occurrence of a stable migrational flow of moisture in the freezing zone is recorded in the experiments (Figure 1). The presence of  $\text{grad } \mu_w$  and the migration of moisture in the freezing zone thus ensure the development of the potential gradients of the moisture and its migration in the thawed zone. This was also recorded in the experiments.

Figure 1

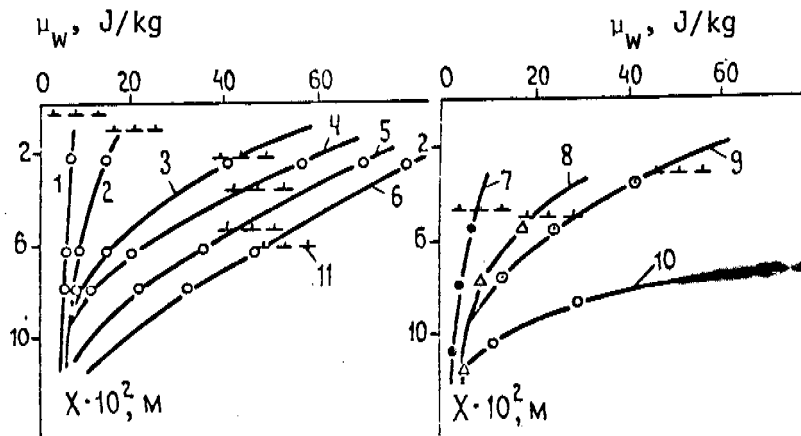

Development with time and depth of the moisture potentials in freezing soils.

Time from beginning of freezing, hours: 1-0; 2-1; 3-2; 4-3; 5-5; 6-7; 7-kaolinitic clay; 8-polymineral (hydro-minaceous-montmorillonitic) clay; 9-clayey silt; 10-sandy silt; 11-position of freezing front.

During visual observation of further freezing and segregated ice formation it proved possible to distinguish clearly three typical zones: I - a thawed zone, II - a freezing zone (in which rapid phase transformations of moisture occur, forming crystals and thin lenses of ice), and III - a frozen zone (for the most part with a lensed cryogenic structure, the segregated ice formation in which is relatively slow). Zones II and III have a lighter hue than zone I, which is due to the presence in the latter of a large quantity of liquid moisture and the absence of ice. The boundary between zones I and II is the freezing front, and between zones II and III is the visible boundary of segregated ice formation.

The experiments indicate that in the initial period of freezing the visible boundary of segregated ice formation lags behind the freezing front. Subsequently, as the freezing process slows and eventually ceases the visible boundary of lensed ice formation is seen to draw closer to the freezing front and ultimately the two fronts merge. Here, at the beginning of freezing the temperatures of the freezing front  $t_{\xi fr}$  and at the front of the segregated ice formation  $t_{\xi si}$  have lower values and  $t_{\xi fr} > t_{\xi si}$ . With further freezing the soil temperature at these fronts rises (Figure 2), and segregated ice formation accordingly occurs in a range of higher below-freezing temperatures, which on the whole is in agreement with the findings of other authors (Puzakov, 1960; Orlov, 1962).

Also closely associated with the development of the freezing zone is the formation (of the experimentally determined) motive forces of moisture migration  $\text{grad } \mu_w$ . Thus, during the first period of freezing an abrupt increase occurs in the potential gradients in the unfrozen zone of the soil, which thereafter decrease and at the final instant of freezing, when degeneration of zone II occurs, they drop to almost zero (Figure 2).

Thus, potential gradients of moisture originating in the freezing zone are the cause of moisture migrating from the unfrozen zone into the freezing zone. In the general case the migrational flow developing can be separated into two components. One of them is caused by the internal moisture exchange and dewatering of the unfrozen zone of the ground itself, the other by an influx of water from outside, for example, from an aquiferous layer. The study of the time-related change that occurs in the density of the overall migrational flow  $I_w$  under the conditions obtaining in both "open" and "closed" systems of soils, showed that  $I_w$  decreases as freezing progresses, in accordance with the drop in  $\text{grad } \mu_w$  and  $\text{grad } t$  (Figure 2). The internal migrational flow of the moisture depends not only on the freezing regime but also on the shrinkage properties of the soil. It follows from the experiments that in accordance with the higher values of the moisture potentials here the regions adjacent to the freezing zone dewater most rapidly. As the distance from the freezing front increases the rate of dewatering ( $\gamma_0 = -\frac{\partial I}{\partial x}$ ), like  $I_w$ , decreases in accordance with the decrease in  $\text{grad } \mu_w$  (Figure 3). As a result of the dewatering of the soil, consolidated regions formed in advance of the

Figure 2

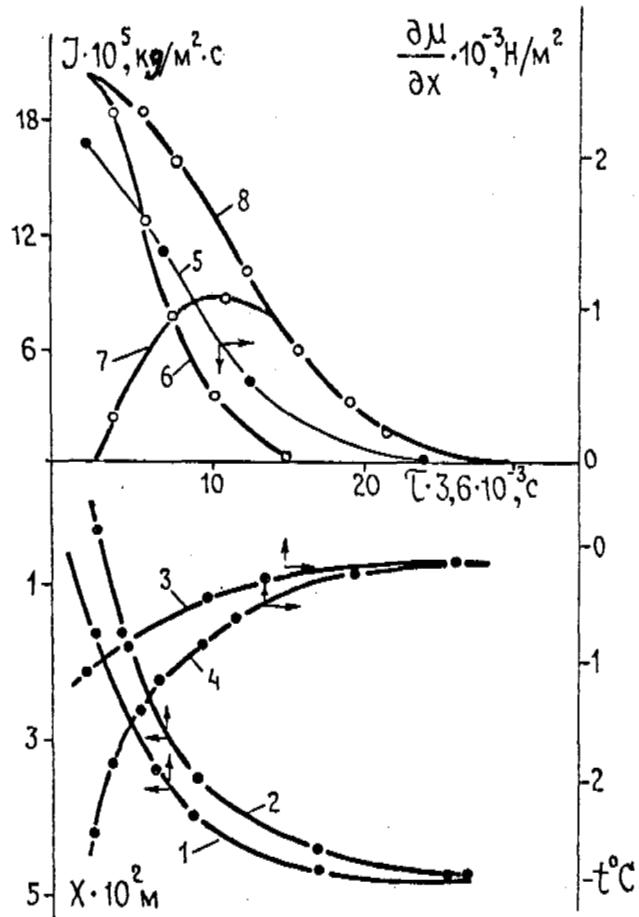

Variation with time in

- 1) the position of the freezing front;
- 2) the visible boundary of segregated ice formation;
- 3) the temperature at the freezing front  $t_{\text{Efr}}$ ;
- 4) the temperature of segregated ice formation  $t_{\text{ESi}}$ ;
- 5) the moisture potential gradients in the thawed zone of the freezing soil;
- 6) the density of the interior migrational flow at the freezing front;
- 7) the density of the exterior migrational flow at the freezing front;
- 8) the density of the summated migrational flow at the freezing front.

freezing front. Essentially, these were merely a region of transit moisture migration from deeper layers in which the density of the migrational flow remained constant. Here, although throughout the freezing process as a whole the degree of infilling of the pores of the originally saturated soil samples had not changed and was close to unity, the total porosity had decreased on account of the consolidation of the ground during its dewatering.

Figure 3

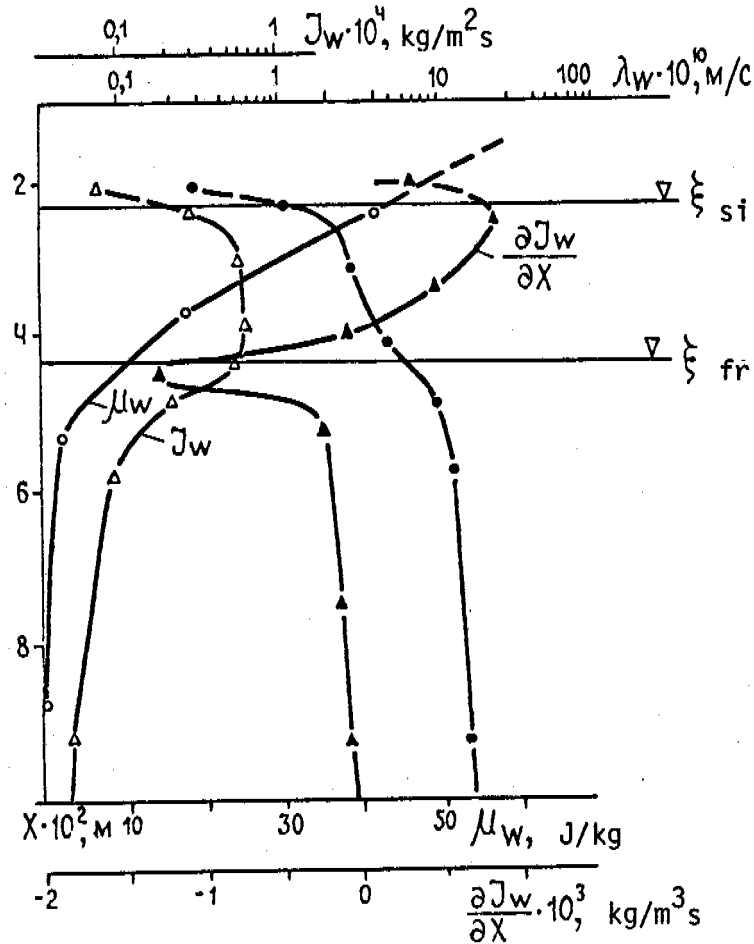

The variation in relation to the depth of the freezing saturated clay of: the moisture potentials  $\mu_w$ , the coefficients of moisture conductivity  $\lambda_w$ , the density of the migrational flow of moisture  $I_w$ , and the rate of de-watering and ice accumulation  $\frac{\partial I}{\partial X}$ .

The monotonous character of the  $\mu_w(x)$ ,  $I_w(x)$  and  $\lambda_w(x)$  curves during passage from the thawed to the freezing zone of the soil is indicative of the continuity of the moisture flow at the freezing front (Figure 3). The analysis of the character of the change in the density of the migrational flow of moisture in the freezing zone indicates that it decreases gradually towards the interior of the zone and that this decrease is most rapid close to the visible boundary of segregated ice formation, which also corresponds to the most rapid ice accumulation here ( $\gamma_i = \frac{\partial I}{\partial X}$ ) (Figure 3). In the frozen zone (III) there is merely a local and on the whole, less rapid migration of moisture in individual thin layers of ice (or blocks) and some degree of

increase in the ice content and thickness of the ice lenses in the lower temperature range.

Parallel with this it should be noted that the presence of the aquiferous layer increases  $\mu_w$  in the regions of soil adjoining it and, in steepening the potential gradients of the moisture, leads to a growth of the total migrational flow on account of the intensification of the external mass transfer, that is, the increase in the migrational flow entering the freezing ground from the aquiferous layer. The character of the time-related variation in the external, internal and total migrational flows of moisture in the clay is illustrated in Figure 2, from which it follows that after the attainment of maximum values at the end of freezing, the migrational flows of moisture drop to almost zero.

The study of the laws governing the change in the parameters of the moisture migration process in freezing soils in relation to their particle sizes and mineralogical composition showed that as their particle sizes become smaller the moisture potentials and their gradients increase, while the coefficients of moisture conductivity  $\lambda_w$  decrease. Thus, in the actual experiments, from clays to sandy silts  $\lambda_w$  increased from  $1.05 \times 10^{-8}$  to  $4.1 \times 10^{-8}$  cm/sec. The significant decrease in the gradients  $\mu_w$  in the series clay-clayey silt-sandy silt leads to a decrease in the magnitudes of the moisture flows and ice formation (in clay  $I_w = 7.3 \times 10^{-6}$  g/cm<sup>2</sup>sec, in clayey silt it is  $7.0 \times 10^{-7}$  g/cm<sup>2</sup>sec, and in sandy silt it is  $3.0 \times 10^{-8}$  g/cm<sup>2</sup>sec). Further, in the clays and the clayey silts the major role in the moisture transfer process is played by internal moisture exchange on account of the greater capacity for shrinkage; in the sandy silts, external moisture exchange has the major role (in clay  $I_{ext} = 3.0 \times 10^{-6}$  g/cm<sup>2</sup>sec and  $I_{int} = 5.3 \times 10^{-6}$  g/cm<sup>2</sup>sec; in clayey silt  $I_{ext} = 0.08 \times 10^{-6}$  g/cm<sup>2</sup>sec and  $I_{int} = 1.8 \times 10^{-6}$  g/cm<sup>2</sup>sec; in sandy silt  $I_{ext} = 0.07 \times 10^{-6}$  g/cm<sup>2</sup> and  $I_{int} \ll 0.01 \times 10^{-6}$  g/cm<sup>2</sup>sec). In soils that vary in their mineralogical composition the total migrational flow of moisture has lower values (in an actual experiment in kaolinitic clay  $I_w = 12 \times 10^{-6}$  g/cm<sup>2</sup>sec; in montmorillonitic clay it is  $8.1 \times 10^{-6}$  g/cm<sup>2</sup>sec). In samples of montmorillonitic clays, however, the internal migrational flow of moisture usually predominates (by one to two orders) on account of the lower

coefficients of permeability and the greater capacity for shrinkage during dewatering of the unfrozen zone. Conversely, in kaolinitic clay, the external migrational flow is substantially greater than the internal ( $I_{ext} = 9.1 \times 10^{-6}$  and  $I_{int} = 2.9 \times 10^{-6}$  g/cm<sup>2</sup>sec).

The above discussed results of the experimental study of the freezing process were concerned for the most part merely with the necessary condition for ice lens formation, that is, heat- and mass exchange. Nevertheless, as indicated by the analysis of the experimental results, there still exists an adequate physical-mechanical condition for the formation of thin layers of ice (Kudryavtsev et al., 1974, 1976). Accordingly it is necessary to dwell in greater detail on the texture formation process, on shrinkage, swelling and the stressed-strained state of freezing soils.

Each of the three zones distinguished in the freezing soils, as indicated by their study with the scanning electron microscope, is characterised by a specific pattern of development with respect to the texture formation process. Due to the transfer of moisture into the freezing zone, shrinkage of the thawed zone (I) is accompanied by an orientation of the particles along the migrational flow, their convergence and the formation of microaggregates, which is confirmed by a change in the microaggregate composition (Ershov et al., 1977). The mass by volume of the soil skeleton of the thawed zone usually increases by 0,1 to  $0.3 \times 10^3$  kg/m<sup>3</sup> and thereby reaches the shrinkage limit, which was also noted previously (Fedosov, 1935, Ershov et al., 1976). The study of soils of differing composition and structure showed that shrinkage strain builds up with an increase in the particle sizes and porosity of the soil, and also with an increase in the relative content of minerals of the montmorillonite group. It was established experimentally that the rate of freezing also influences the value of the shrinkage strains. The lower the rate of freezing the greater the dessication, the consolidation and the shrinkage strain (Figure 4).

The magnitude of the shrinkage  $h_{shr}$  in freezing soils can be very considerable and in some cases even comparable to the thickness of the thin layers of ice undergoing formation. When calculating the heaving magnitude  $h_{he}$  it is therefore necessary to take into consideration the shrinkage strain.

In the general form this can be written:

$$h_{he} = h_{tsi} - h_{shr}$$

where  $h_{tsi}$  is the total thickness of the thin layers of ice in the strained state (Kudryavtsev et al., 1974).

Figure 4

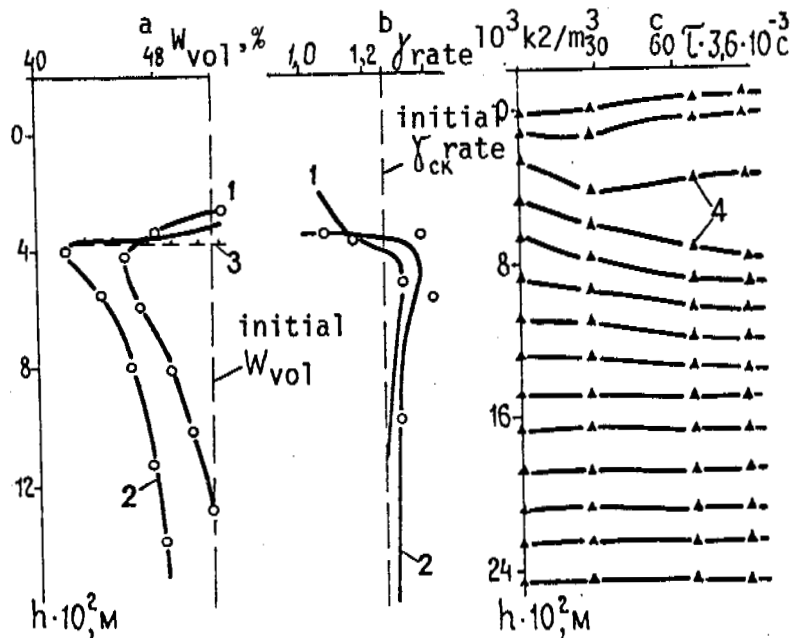

Variation in (a) the moisture content and (b) the density of kaolinitic clay according to (c) the depth and nature of displacement of the strain gauges placed in it. 1 and 2 - rate of freezing of the clay  $2.1 \times 10^5$  m/sec and  $0.57 \times 10^5$  m/sec respectively; 3 - freezing front; 4 - position of the strain gauge.

It is in the freezing zone (II), where the principal role in texture formation is played by migrating moisture and the crystals of ice forming in large pores, that the swelling and distension processes take place. The action of the swelling and distension forces results in a rearrangement of the texture of the mineral skeleton that has been forming at the above-freezing temperature. In this zone a partial fragmentation of the previously developed microaggregates occurs. The microblocks are turned



around, disturbing the established orientation. As a rule the smallest of the particles form a "jacket" around the microblocks.

In the frozen zone (III) of the soil a further rearrangement of the texture occurs. The crystals of ice forming in the minute pores apparently cause splitting of the microblocks and microaggregates observed in the freezing zone. The orientation of the microaggregates which is typical of the unfrozen zone disappears. According to the results of the microaggregate analysis, in the frozen zone of the soil there is an increase in the content of particles and microaggregates of the very fine fraction (Ershov et al., 1977).

The migration of moisture from the thawed into the frozen zone, the dewatering of the soil below the freezing front and the ice segregation in the freezing zone lead to the development of a field of volume- and gradient stresses in the finely particulate freezing soils. Furthermore, in the freezing zone, non-uniform swelling and distension strains develop and corresponding to them, swelling stresses  $P_{sw}$  and distension stresses  $P_d$ , and in the thawed zone - non-uniform shrinkage strains and stresses  $P_{shr}$ . The interaction between the forces acting in different directions in freezing soils results in the origination of the following shear stresses  $P_{sh}$ :

$$P_{sh} = P_{shr} + P_{sw} + P_d$$

and the following normal (perpendicular to the freezing front) tensile stresses  $P_t$ :

$$P_t = P_{shr} - (P_{sw} + P_d).$$

As is well known, the presence of stresses leads to the formation in the soil of zones of stress "concentrations" at places where the texture bonds are weakened. In freezing soils the boundaries of the microaggregates that had developed as a result of texture formation during shrinkage will be zones of stress "concentrations". Furthermore, the shear stresses will favour the development of horizontal (or near horizontal) stress concentration zones and

the tensile stresses will favour the development of vertical zones. It is toward these zones (horizontal, vertical or inclined), the water in which is subject to tensile stress, that the migrational flow of moisture will be directed under the influence of the  $P_t$  and  $P_{sh}$  gradients. If the magnitude of the stresses developing in the freezing soil is sufficient to overcome the local textural cohesiveness of the soil  $P_{coh \cdot \lambda}$ , the nucleation must then occur of horizontal ice lenses in accordance with the condition:

$$P_{shr} + P_{sw} > P_{coh \cdot \lambda} + P_{tr} \quad (1)$$

and of vertical ice lenses in accordance with the condition:

$$P_n = P_{shr} - P_{sw} > P_{coh \cdot \lambda} + P_{tr} \quad (2)$$

where  $P_{tr}$  is the external pressure (including the true pressure according to the altitude of the freezing soil). The findings of D.S. Goryacheva indicate that the swelling pressure is associated by a rectilinear dependence with the weight by volume of the soil and its moisture content and ranges from  $0.2 \times 10^5 \text{ H/m}^2$  at a soil density of  $1.2 \times 10^3 \text{ kg/m}^3$  to  $1.10^5 \text{ H/m}^2$  at a soil density of  $1.45 \times 10^3 \text{ kg/m}^3$ .

Experimental studies have shown that in freezing soils, depending on their composition, structure and properties, and also on the conditions of freezing, the magnitude of the normal tensile stresses  $P_t$  can range from 0 to  $0.2 \times 10^5 \text{ H/m}^2$  to  $2 \times 10^5 \text{ H/m}^2$ . Based on the magnitude of the recorded values of  $P_t$ , freezing soils can be arranged in the following series: clay > clayey silt > sandy silt. Thus, for example, during freezing under identical conditions the following  $P_t$  magnitudes were recorded: in kaolinitic clay,  $0.80 \times 10^5 \text{ H/m}^2$ , in polymineral clay,  $0.60 \times 10^5 \text{ H/m}^2$ , and in finely particulate clayey silt,  $0.56 \times 10^5 \text{ H/m}^2$ . During the development of normal tensile stresses the original microstructure and mineralogical composition of the soils has a higher values. If the soil structure consists of microblocks then, as a rule, the instrument readings of  $P_t$  are of smaller magnitude as shrinkage strain occurs along the blocks. Samples of bentonitic and polymineral clays afford a vivid example of this.

Figure 5

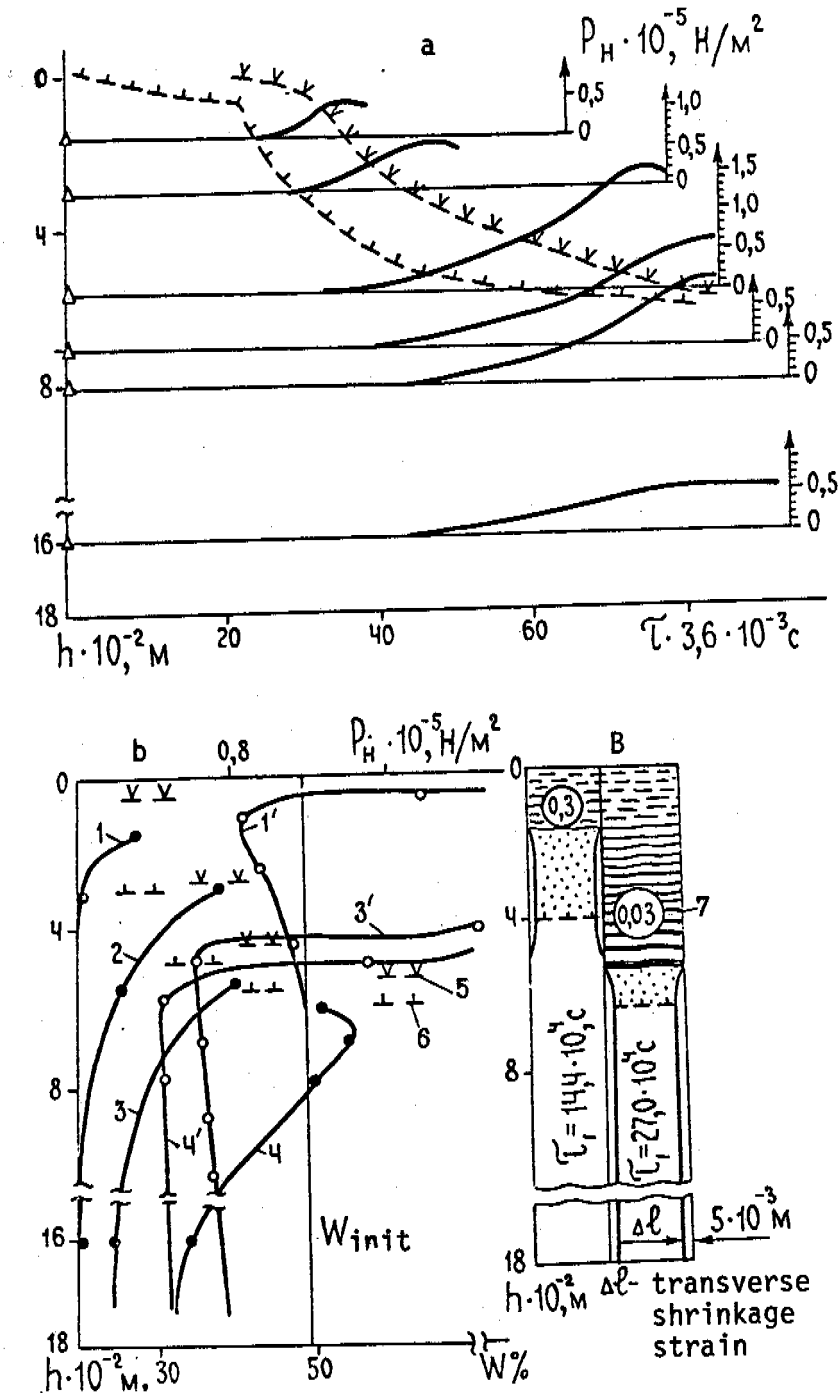

Variation (a) with time and (b) with depth, of the volume and gradient stresses (1,2,3,4) and the moisture content (1', 3', 4'); (c) character of the cryogenic structures. Time, secs; 1,1' -  $33 \times 3,6 \times 10^3$ ; 2 -  $45 \times 3,6 \times 10^3$ ; 3,3' -  $60 \times 3,6 \times 10^3$ ; 4,4' -  $80 \times 3,6 \times 10^3$ ; 5 - visible boundary of segregated ice formation; 6 - freezing front; 7 - rate of freezing, cm/hr.

In the same soil a regular increase in the normal tensile stresses is observed with a decrease in the rate of freezing and an increase in the degree of dewatering. In kaolinitic clay, for example, with a decrease in the rate of freezing from 0.3 to 0.03 cm/hr the normal tensile stresses increased from  $0.4 \times 10^5$  to  $1.5 \times 10^5$  H/m<sup>2</sup>. Here the moisture content of the soil had altered by 20% (Figure 5). In the frozen and freezing zones of the sample horizontal ice lenses had formed, since the  $P_t$  magnitudes that had caused them to develop were insufficient to overcome the local structural cohesiveness of the soil in the vertical direction. Thus, with a freezing rate in the kaolinitic clay of 0.2 cm/hr ( $W_{init} = 50\%$ ,  $\gamma_{sh} = 1.20 \times 10^3$  kg/m<sup>3</sup>) in the temperature range corresponding to ice lens segregation, normal tensile stresses of  $P_t = 0.7 \times 10^5$  H/m<sup>2</sup> were recorded. At this instant the swelling stress corresponding to the soil density ( $\gamma_{sh} = 1.32 \times 10^3$  kg/m<sup>3</sup>) is  $0.65 \times 10^5$  H/m<sup>2</sup>, and the local structural cohesiveness of the soil (according to laboratory determinations of these conditions)  $P_{coh-\ell} = 1.5 \times 10^5$  H/m<sup>2</sup>. In accordance with condition (2)  $P_{shr} = 0.7 \times 10^5 + 0.65 \times 10^5 = 1.35 \times 10^5$  H/m<sup>2</sup>. In accordance with condition (1) the shear stresses can then be written as  $P_{sh} = 1.35 \times 10^5 + 0.6 \times 10^5 = 2.0 \times 10^5$  H/m<sup>2</sup>. Consequently, in the experiment which has been discussed the formation of only horizontal ice lenses should have been and was in fact observed. The formation of vertical lenses could not have occurred, as  $P_t = 0.7 \times 10^5$  H/m<sup>2</sup> and would have been unable to overcome the local structural cohesiveness ( $P_{coh-\ell} = 1.5 \times 10^5$  H/m<sup>2</sup>). The frequency of the ice lenses in the freezing zone is predetermined by the gradient of the stresses developing in the soils. As the experimental studies showed, as the rate of freezing decreases the volume- and gradient stresses increase although their gradients decrease (Figure 6), which also predetermines the more sparse arrangement of the ice lenses in the developing cryogenic structure.

The example provides striking evidence that the formation of a particular type of cryogenic structure when the thermal condition is met is predetermined by the physico-mechanical processes developing during freezing of the soils.

The above discussed mechanism and laws governing moisture migration and ice lense segregation in the frozen zone of freezing soils in many ways

Figure 6

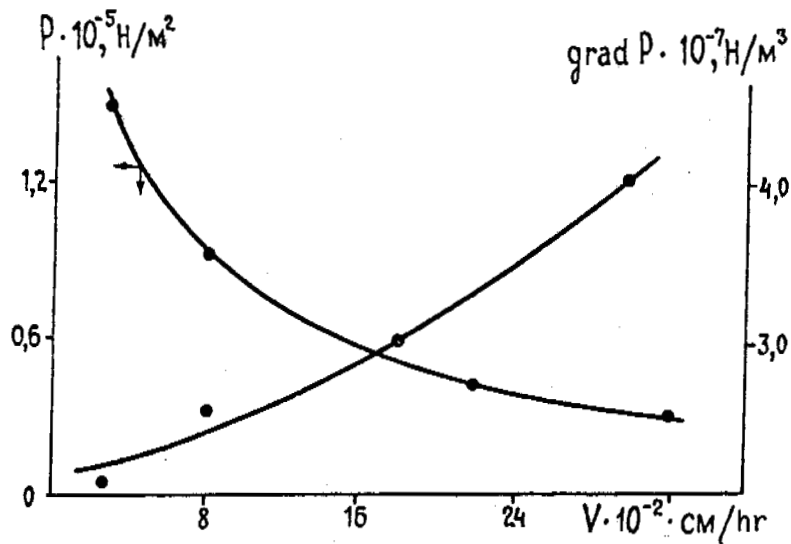

Dependence of volume and gradient stresses and their gradients on the rate of freezing.

closely resemble the same processes during their thawing, although there are definite differences between them. The migration of the unfrozen water and the formation of thin ice layers during thawing occurs in the totally unthawed, frozen zone of the soil under the influence of the prevailing temperature gradient there, which leads to the manifestation of a grad  $W_{fr.z}$  and correspondingly, a grad  $\mu_w$ . With thawing as opposed to freezing however, the process of segregated ice formation takes place against a background of an overall increase (rather than a decrease) in the temperature of the frozen zone. Accordingly, the thin layers of segregated ice originating at low temperatures (corresponding to a region transitional to N.A. Tsytovich's zone in which the soil is in an almost frozen state) grow under conditions of an overall increase in the temperature and a zero isotherm closely adjacent to them. After merging with the latter the thin layers of ice cease to grow and begin to melt. When the thawing front is advancing sufficiently slowly, ice layers of considerable thickness succeed in growing in the frozen zone and have been found to have a high content of ground inclusions. Here, a specific cryogenic structure develops which in the literature is frequently referred to as "ataxitic" (Vtyurina and Vtyurin, 1970) or "zonular" (Katasonov, 1960).

The rate of growth of the thin layers of ice in the frozen zone of thawing soil when there is no change in its composition or structure depends on the temperature gradient. For example, when gradient ranged from 0.2 to 0.5 deg/cm in the frozen zone of thawing kaolinitic clay, the density of the migrational flow forming the thin layers of ice increased from  $3 \times 10^{-6}$  to  $7 \times 10^{-6}$  g/cm<sup>2</sup>sec. The values of the coefficients of diffusion of unfrozen water in the 0° to -2°C range varied between  $1.5 \times 10^{-9}$  and  $6 \times 10^{-9}$  m<sup>2</sup>/sec. Furthermore, in the same zone a layered cryogenic structure formed after several days, the thickness of the thin layers of ice ranging from 2 cm close to 0°C to fractions of a mm at -2°C.

The effect of the composition of thawing soils on the migration of moisture and the formation of segregated ice in their frozen zone is analogous to the general law that prevails in freezing soils, i.e., with an increase in the content of minerals of the montmorillonite group or a decrease in the fineness of the soil, when other conditions are equal the rate of the moisture migration and ice formation process decreases.

In order to ensure that the experiments approximated to natural conditions, both a single partial thawing and also a repeated cyclical thawing and freezing of the frozen soils were carried out. An analysis of such experiments showed that as the boundaries of the maximum depth of thaw become higher from cycle to cycle the ice lenses that have formed in the frozen zone become buried. For example, in an experiment with kaolinitic clay involving its repeated freezing and thawing and a simultaneous decrease in the depth of thaw, four icy layers were recorded in which the type of cryogenic structure depended on the rate of thawing and the distance between the icy layers depended on the depth of the thawing layer. If the depth of thaw did not increase but decreased, then simultaneously with a lowering of the freezing front a transformation and downward mixing of the icy layer occurred. In this case the block cryogenic structure that had previously developed was transformed into thick horizontal ice lens.

In conclusion it should be noted that the large complex of experimental studies that has been conducted with respect to moisture migration, texture formation and ice segregation in freezing and thawing soils

has indicated the need for embarking upon a serious and special study of a whole series of thermophysical, physicochemical and physicomachanical processes in freezing and thawing soils. Only on the basis of a combined examination of the geological-geographic, thermophysical and physicomachanical conditions in freezing and thawing soils will it be possible in the future to discover the particular and the general laws governing the cryogenic structure formation process and to work out a system for classifying the various kinds and types of cryogenic structures in relation to the conditions under which they were formed.

#### REFERENCES

- VTYURINA, E.A. and VTYURIN, B.I. Ice formation in soils. Moscow, "Nauka" press, 1970.
- ERSHOV, E.D., KUCHUKOV, E.A. and KOMAROV, I.A. Ice sublimation in finely dispersed soils. Izd-vo Moscow State University (MGU), p. 223, 1975.
- ERSHOV, E.D., CHEVEREV, V.G., SHEVCHENKO, L.V. and SOKOLOV, V.N. Texture formation in finely dispersed soils during freezing complicated by moisture migration. Moscow University. Geol. series (at the printer's), 1977.
- ERSHOV, E.D., SHEVCHENKO, L.V. and LEBEDENKO, Yu.P. Distinctive features of the shrinkage and heaving process in freezing soils of differing composition and properties. In: Permafrost Studies, 15th edition, Izd-vo MGU, pp. 226-227, 1976.
- KATASONOV, E.M. Preliminary classification of the cryogenic structures of permafrost talus deposits. - "Trudy Sev-Vost. otd. In-ta merzlotovedeniya na territoriya Yakutskoi ASSR". (Transactions of the Northeastern Division of the Institute of Permafrost in the Yakut ASSR). Yakutsk, pp. 12-14, 1960.
- KUDRYAVTSEV, V.A., ERSHOV, E.D. and SHEVCHENKO, L.V. Role of the shrinkage process in ice formation and the heaving of freezing soils. "Vestnik MGU. Ser. geol." No. 3., pp. 80-91, 1974.
- KUDRYAVTSEV, V.A., ERSHOV, E.D., CHEVEREV, V.G., LEBEDENKO, Yu.P. and SHEVCHENKO, L.V. Moisture migration and segregated ice formation in freezing and thawing finely dispersed soils. "Papers given at the 5th All-Union Conference on Heat and Mass Exchange." Minsk, pp. 115-125, 1976.
- ORLOV, V.V. Cryogenic heaving of finely dispersed soils. Moscow, Izd-vo AN SSSR, p. 187, 1962.

- PUZAKOV, N.A. The thermal and aqueous regime of roadbeds of highways. Moscow Avtotransizdat, p. 168, 1960.
- FEDOSOV, A.E. Physicomechanical processes in soils during their freezing and thawing. Moscow. Transzheldorizdat, p. 47, 1935.
- CHEVEREV, V.G. and LEBEDENKO, Yu.P. Methodology of laboratory studies of the moisture migration, heaving and ice formation process in freezing and thawing soils. "Results of the 3rd Scientific Conference of Post-graduate Students and Young Scientists of Moscow State University, Hydrogeological series." (VINITI, Dep. No. 247-76), 1975.





EFFECT OF LONG-TERM CRYOMETAMORPHISM OF EARTH MATERIALS  
ON THE FORMATION OF GROUNDWATER

S.M. Fotiev

Industrial and Research Institute for Engineering Surveys in Construction  
Moscow, U.S.S.R.

The conditions of groundwater formation altered radically in the course of the Quaternary period over the immense territory of Eurasia and North America under the effect of cryometamorphism of earth materials. Cryometamorphism combines powerful multiannual physical, physico-chemical and physico-mechanical processes occurring in earth materials as a result of changes in their temperature within the range of negative values. In the event of the rock or soil temperature dropping below  $0^{\circ}\text{C}$ , there are formed, under the impact of cryometamorphism, beds of cryogenic earth materials.

In assessing the effect of cryometamorphic processes in earth materials on conditions, under which groundwater forms, we should focus primarily on the spatial variability analysis of the main characteristics of cryogenic beds that are of primary importance from the hydrogeological viewpoint. We shall define more specifically their role in the transformation of hydrogeological conditions on the territory marked by the distribution of cryogenic earth materials, i.e., in the cryogenic region.

The temperature of earth materials is a zonal factor determining the intensity of the processes of cryogenic metamorphism in earth materials and groundwater and characterizing the changes occurring in their physical, physico-chemical and physico-mechanical properties. The degree of cooling of earth materials within the negative temperature range and its stability in time determine: a) the overall thickness of the belt of cryogenic

metamorphism of earth materials and groundwater; b) the thickness of the cryogenic aquiclude in earth materials saturated with fresh water; c) the possibility of a cryogenic aquiclude developing and its thickness in earth materials saturated with salt water; d) distinctive aspects of the changes occurring in the chemical composition and mineral content of water in the process of its crystallization; e) temperature regime of descending and ascending groundwater flows; and f) the presence or absence of groundwater recharge and runoff areas and their size.

Repeated freezing of water increases the degree of jointing, hence the permeability of the earth materials containing water.

The thickness of cryogenic beds is a zonal and regional characteristics of the present-day hydrocryological environment reflecting the conditions, under which the process of long-term cryometamorphism evolved and its stability in time and space. The thickness of cryogenic beds characterizes the present thickness of the belt of cryogenic metamorphism in earth materials and groundwater within the structures.

The structure and texture of cryogenic beds are intrazonal characteristics of the present-day hydrogeocryological environment reflecting the specific aspects of cryometamorphic processes in earth materials as depending on the presence of gravitational water in cracks and interstices, as well as on its composition and mineral content. The structure and texture of cryogenic beds characterize the correlation within the vertical section of different horizons of cryogenic earth materials varying markedly with respect to their hydrogeological properties (Figure 1).

Under specific hydrogeocryological conditions there form cryogenic beds with distinctive textures and structures (KT-1 - KT-9)\*. Cryogenic beds of each type have their own designation derived from the names of their constituent horizons of cryogenic soils or rocks. The textures and structures of cryogenic beds reflect the possibility of fresh or saline water being present within the structures.

---

\* KT stands for "cryogenic beds". (Transl.).

Figure 1

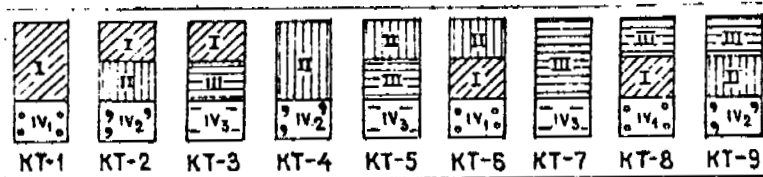

Textures and structures of different types of cryogenic beds

I - horizon of frozen earth material (cracks and interstices are filled with ice) - a cryogenic aquiclude; II - horizon of cooled\* earth materials (cracks and interstices are filled with salt water) - water-permeable earth materials; III - horizon of frost\* earth materials (with cracks and interstices containing neither water, nor ice, or homogeneous rock) - air-dry earth materials; IV - earth materials with positive temperatures, where cracks and interstices may contain fresh water (1), saline water (2) or no water (3).

The thickness and discontinuity of the cryogenic aquiclude are zonal and regional characteristics of cryogenic beds determining the major distinctive aspects of cryogenic changes in the conditions of formation of groundwater within the structures. The thickness of the cryogenic aquiclude may be equal to the total thickness of the cryogenic beds or to a fraction thereof (Figure 1).

The thickness of the cryogenic aquiclude differentiates the feasibility of the groundwater recharge and runoff as a function of the water, soil and rock temperature, as well as of the discharge of ascending or descending flows; it separates in space the once integral hydrodynamic systems or weakens the links between their constituent parts; it changes the direction, velocity of motion and regimen of groundwater; it determines the distinctive aspects of the hydrodynamic and hydrochemical zoning of groundwater and the capacity of the given structure; it alters hydraulic properties of individual aquifers or systems of aquifers and determines the temperature conditions of ascending and descending groundwater flows.

\* The terms "cooled" and "frost" are the Russian terms used (okhlazhdennyi and moroznyi, respectively) translated literally. These terms appear to refer to new concepts introduced by the author in this paper and have therefore no equivalents in English (Transl.).

The discontinuity of the cryogenic aquiclude characterizes the size of groundwater recharge and runoff regions and determines the specific aspects and activity of water exchange.

The principal characteristics of cryogenic beds repeatedly and fundamentally altered in the course of the Quaternary period. In studying specific aspects of the cryogenic changes in hydrogeological conditions within the structures of the present-day cryogenic region or even outside its boundaries, it is therefore imperative to find answers to a number of highly important questions. When did the long-term freezing of earth materials begin? What is the length of continuous existence of cryogenic aquicludes? How did their thickness and intermittent pattern of existence, as well as the temperature of their constituent earth materials change in time? We can answer these questions only proceeding from a thorough study of the developmental history of cryogenic beds.

The evolutionary history of the cryogenic beds found on the territory of the U.S.S.R. has been studied mainly in isolated regions, and so far there are very few works pertaining to the territory as a whole (Velichko, 1973). Analyses of the new data material accumulated by Soviet researchers in the last 10 - 15 years, evidenced that the process of long-term cryometamorphism of soils and rocks developed during the Pleistocene and Holocene virtually throughout the territory of the U.S.S.R. and was a latitudinal, as well as an altitudinal zonal phenomenon. The numerous and varied traces of long-term cryometamorphism in earth materials are generally arranged in the form of zones differing with respect to the duration and intensity of the cryogenic metamorphic processes of earth materials, which took place within their boundaries. This circumstance is naturally reflected in the thickness of the cryogenic beds of earth materials and in the length of their continuous existence.

Proceeding from an analysis of the history of evolution of cryogenic beds and from the belief that the warm Holocene epoch was an important climatic boundary, the author established on the territory of the U.S.S.R. three geocryological zones: the Northern and Southern zones of long-term cryometamorphism of soils and rocks, the boundary between which

Figure 2

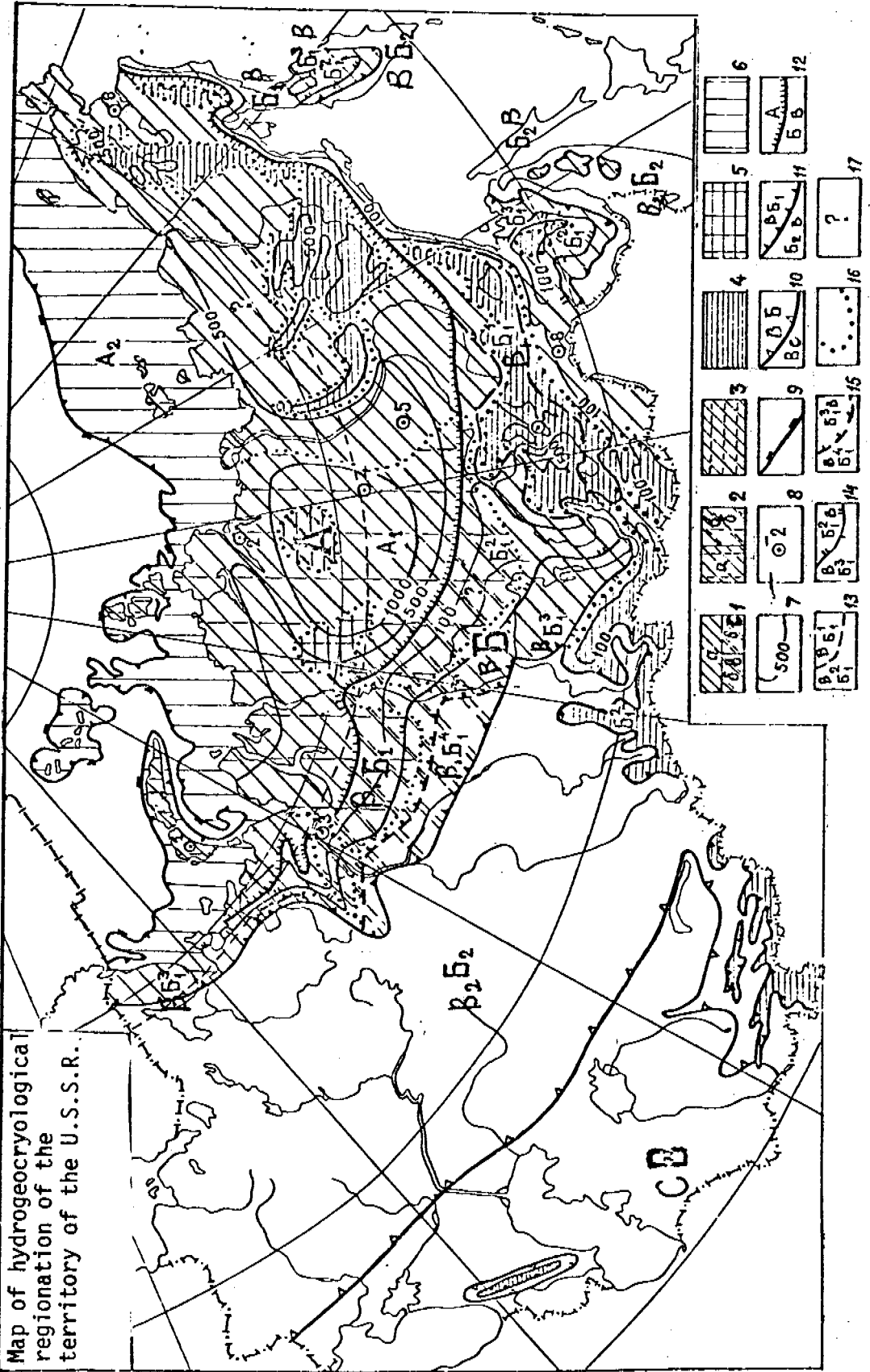

Figure 2

Map of hydrogeocryological regionation of the territory of the U.S.S.R.

1 - Fresh-water province: a) - the roof of the cryogenic aquiclude at the dept of 5 m or less; b) - asynchronous cryogenic aquicludes separated by a horizon of thawed earth materials; c) - the roof of the cryogenic aquiclude at the depth of 100 - 200 m; 2 - Subaerial salt-water province: a) - the roof of the cryogenic aquiclude at the depth of the 5 m or les;; b) - the roof of the cryogenic aquiclude at the depth of 100 - 200 m; 3 - The province of air-dry earth materials; 4 - The province of fresh water and air-dry earth materials; 5 - The province of salt water and air-dry earth materials; 6 - The submarine salt-water province; 7 - Isolines of the thickness (m) of cryogenic beds (after I.Ya. Baranov, V.V. Baulin and S.M. Fotiev); 8 - The location of the hydrogeocryological profile and its number in Figure 3. Boundaries: 9 - of firm land in the Upper Pleistocene (after N.N. Nikolaev and V.V. Shul'ts); 10 - Of the cryogenic region during the Pleistocene climatic minimum (after A.A. Velichko as supplemented by S.M. Fotiev); 11 - Of the cryogenic region during the Recent period (after I.Ya. Baranov, V.V. Baulin and S.M. Fotiev); 12 - Between the Northern and Southern zones; 13 - Of the area with cryogenic beds which did not undergo surface degradation during the Holocene ( $B_1^1$ ); 14 - Of the area with discontinuous ( $B_1^2$ ) and sporadic ( $B_1^3$ ) cryogenic aquicludes; 15 - Of the area marked by the distribution of Upper Holocene cryogenic beds (after V.V. Baulin and N.G. Oberman); 16 - Of the area with different types of cryogenic beds; 17 - same, established tentatively.

Explanation of the index letters is provided in the text.

coincides with the line of junction of the Pleistocene and Upper Holocene cryogenic beds; and the zone of seasonal cryometamorphism of earth materials (Figures 2A, B and C). Within the confines of the Northern zone (A) the freezing of earth materials continued for tens and hundreds of thousands of years without interruptions, whereas on the territory of the Southern zone (B) this period of time represents a repeated alternation of the epochs marked by long-term freezing of earth materials with epochs of multiannual thaw. Within the zone of seasonal cryometamorphism (C) the process of freezing of soils and rocks annually gave way to thaw processes.

The differences in the development of long-term cryometamorphic processes in earth materials are naturally reflected in the formation of the characteristics observed in cryogenic beds at the present time. Whereas in the territory of the Northern zone the temperature of the earth materials varies between  $-2^0$  and  $-16^0$  and the thickness of continuous cryogenic beds is 500 - 1500 m or more, the soil and rock temperature on the territory of the

Southern zone varies between 0°C and 2 - 3° below 0°C and the thickness of discontinuous cryogenic beds and permafrost islands does not exceed 100 - 150 m. This evidences that the effect of cryometamorphism of earth materials on the conditions of formation of ground water was highly non-uniform in different geocryological zones.

The Northern zone of long-term cryometamorphism of earth materials is located north of the line of junction of Pleistocene and Upper Holocene cryogenic beds. The zone covers most of the area (61%) of the present-day subaerial cryogenic region (Figure 2A). In the course of the Quaternary period, during the epoch of the Pleistocene thermal minimum in particular (after A.A. Velichko), the earth materials were cooled to low (-20°C or even lower) negative temperatures ensuring high intensity of the processes of cryometamorphism in the soils and rocks. The low temperature of the freezing earth materials combined with the lengthy duration and great stability of their cooling period are the factors responsible for the considerable (up to 1500 m and more) thickness of the cryogenic beds. This is why the hydrogeological environments formed within different structures prior to the beginning of the Quaternary period underwent the most thorough cryogenic metamorphism on the territory of the Northern zone.

The intensity of cooling of earth materials and the stability in time of the processes of long-term cryometamorphism of soils and rocks were uneven within the boundaries of that immense territory. The distinctive regional developmental patterns of this process were determined in a number of ways by the climate growing generally more continental and harsher, as well as by its stability in time in the eastern direction throughout the Quaternary period. This is reflected in the drop in temperature of the earth materials, in the increased thickness and age of the cryogenic beds, and in the eastward expansion of the Northern zone along the meridian. The development of long-term cryometamorphism of earth materials within the boundaries of the Russian and West Siberian Platforms and Chukchi peninsula became increasingly non-uniform as a result of repeated and lengthy advances of the sea, during which large portions of firm land were flooded in the Pleistocene. Under submarine conditions the cryogenic beds formed earlier became completely or partially degraded, whereas in subaerial environments



the process of cryometamorphism of earth materials continued without interruptions. The intrazonal spatial non-uniformity of the thickness of cryogenic beds from various regions located in different parts of the zone, is shown in Figure 2.

Distinctive aspects of cryometamorphism of earth materials within individual regions were determined by the specific correlation inside each structure of the thickness of cryogenic beds on the one hand, that of the fresh-water zone, of the zone of regional jointing of soils and rocks of air-dry earth materials on the other. The structures and textures of cryogenic beds formed under different hydrogeocryogenic conditions, are shown in Figure 3.

Figure 3

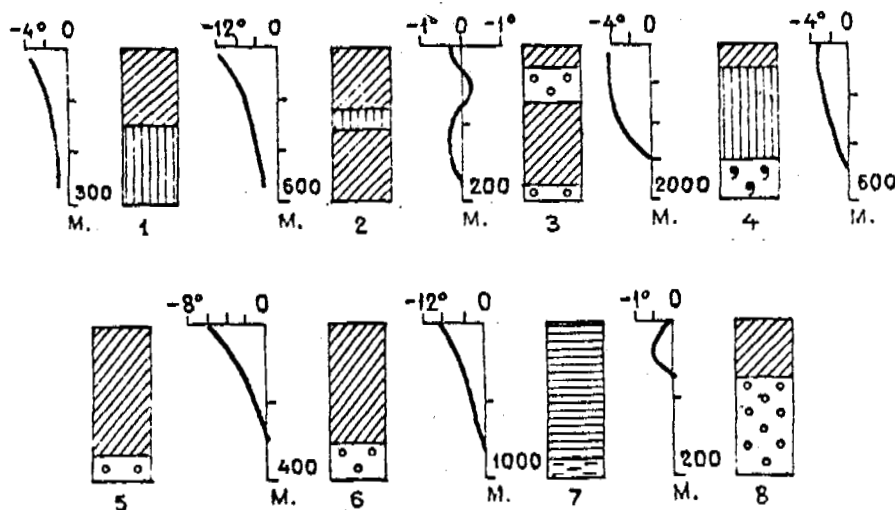

Hydrogeocryological sections of cryogenic beds (the location of the profiles is shown in Figure 2).

The paleohydrogeocryogenic conditions, under which different types of cryogenic beds formed, were analyzed by the author earlier (Fotiev, 1975). This analysis permits us to differentiate the territory of the Northern zone into hydrogeocryological provinces marked by the occurrence within their structures of soils or rocks containing fresh or salt waters, or of air-dry earth materials. Each province is characterized by a definite combination of different types of cryogenic beds. The fresh-water province is characterized

by the predominant development of frozen soils or rocks (KT-1), whereas beds of cooled or frozen earth materials (KT-6) occur at localized sites in the shelf, and while beds of frozen or frost soils or rocks (KT-8) are found only in mountainous regions. The salt-water province is characterized by a predominant development of beds composed of earth materials frozen or cooled (KT-2) under subaerial conditions or of beds with soils or rocks cooled (KT-4) in subaqueous (submarine) environment, while beds of frost and cooled earth materials (KT-9) develop at local sites under subaerial conditions. The province of air-dry earth materials is characterized by a predominant development of beds with frozen and frost (KT-3) or only frost (KT-7) earth materials, while beds of cooled or frost soil or rock (KT-5) develop at localized sites in the shelf.

The most significant cryogenic changes in the conditions of groundwater formation occurred in the structures, where, as a result of the crystallization of water in interstices and cracks of soils and rocks, there formed low-temperature cryogenic aquicludes. They persisted continuously for tens and hundreds of thousands of years and covered over 95% of the area. Even during the epochs of climatic warming their degradation was partly possible only from the bottom up on account of the heat flux from the Earth's interior. Under these harsh and stable geocryological conditions the groundwater recharge and runoff regions confined to open water-absorbing or water-tapping taliks, concentrate in all the structures exclusively in river-valley floors. Because of the concentrated heat and moisture transfer, they exist only at localized sites. The association of the recharge and runoff regions with rejuvenated tectonic fractures has unequivocally determined the dependence of water-exchange activities upon the mobility of the regions during the Neogene-Quaternary phase of tectogenesis. Differences in the activity of water exchange are naturally reflected in the thickness of the fresh-water zone, and in the thickness, texture and structure of cryogenic beds, hence in the distribution of hydrogeocryological provinces. On the territory of the Northern zone fresh-water provinces are confined for the most part to the mountainous region of Eastern Siberia, whereas salt-water provinces occupy here the shelf, the islands and most of the northern territory in Western and Eastern Siberia.

The mountainous-folded region of Eastern Siberia is characterized by the most recent activity tectonic movements with an amplitude of 500 to 2000 m or more. The specific aspects of cryogenic metamorphism of earth materials within individual structures have been determined by the hydrogeological environments formed therein prior to the beginning of the Quaternary period.

In most structures the thickness of frozen beds was smaller than that of the fresh-water zone due to the active water exchange throughout the Quaternary period. In isolated structures with less favourable conditions with regard to water exchange the thickness of the fresh-water zone proved to be commensurable with that of frozen beds, which resulted in the occurrence of brackish water directly underneath the frozen soil or rock. In the mountain massifs marked by highly contrasting most recent movements of a considerable amplitude, by abundant tectonic faults and a deeply eroded relief, the water-bearing associations of earth materials occurring above the base level, were drained to a fairly great depth, while in the rocks occurring below the base level there formed a thick fresh-water zone due to the active water exchange. These differences in the hydrogeological environment predetermined the development of different types of cryogenic beds. Thick (500 - 900 m) cryogenic beds represented mainly by frozen earth materials (KT-3, KT-7 and KT-8), formed above the base level, while beds of frozen earth materials formed in these structures and in depressions below the base levels. Due to the active movement of groundwater, their thickness is azonal (200 - 300 m). Fresh water persists in these structures even under the harshest geocryological conditions (Figure 2).

Platform regions are characterized by weak manifestations of the most recent tectonic movements with predominance of lengthy subsidences or stable upheavals ranging between -100 and +300 m in amplitude. The newest tectonic faults are not characteristic of the platform. Because of the negligible degree of erosion the relief is here only slightly rugged and the earth materials have not been washed through percolation. In basins of this kind the thickness of cryogenic beds surpassed that of the fresh-water zone. This circumstance has resulted in extensive distribution of the second type of cryogenic beds over the territory of the platform (Figure 2).

Present-day characteristics of cryogenic beds from different basins suggest that they formed under different conditions. In the West Siberian basin, the territory of which was repeatedly flooded by desalinated sea water, saline water is found in the circum-Enisei area below the horizon of frozen soils and rocks, at the depth of the order of 200 m. The low content of mineral matter (10 - 15 g/l) and the high ( $-1^{\circ}\text{C}$ ) negative temperature of the water in the upper part of the layer of cooled soils or rocks evidenced that they were little affected by cryogenic metamorphism. The total thickness of cryogenic beds is here of the order of 400 m. In the north-eastern part of the Siberian Platform the circumstances of cryogenic metamorphism of earth materials and groundwater were different. Stable, harsh, acutely continental climatic conditions predetermined a considerable cooling of soils and rocks and continuous aggradation of cryogenic beds throughout the Pleistocene. This may be the reason for the unique present-day geocryological environment in the Olenek basin, an environment unlike anything known on Earth. Cryogenic beds attain here a thickness of 1500 m, whereas the thickness of the layer of frozen earth materials does not exceed 200 m (Mel'nikov, 1966; Balobae et al., 1973). The magnesium-calcium chloride composition of brines, their high (up to 100 g/l) mineral content and low ( $-5^{\circ}\text{C}$ ) temperature in the upper part of cooled soil or rock horizon evidence the significant development of cryogenic metamorphism therein. The abundance of mirabilite crystals within the cracks in earth materials suggests that during the Pleistocene soils and rocks were cooled to considerably lower temperature (below  $-8^{\circ}\text{C}$ ) at that depth (Kononova, 1974). Hydrogeocryological provinces with saline water are found virtually everywhere on islands and in isolated areas on the Arctic coast, where groundwater is linked hydraulically to the sea (Neizvestnov et al., 1971).

Within the boundaries of the Anabar massif cryogenic beds also measure over 1000 m in thickness, but their textures and structures are entirely different. Cryogenic beds of the third type formed here as a result of cryogenic metamorphism of crystalline rocks. The features characteristic of this province of air-dry earth materials are the negligible (up to 50 - 100 m) thickness of the frozen soil or rock layer coinciding with the thickness of the ancient water-laden weathering crust, and the unparalleled thickness of the layer of "frosty" soil materials. The massif contains no

underground waters other than the groundwater found in the seasonally thawing layer or in closed taliks from river valleys (Underground water....., 1967).

Fresh water escaped freezing on the territory of the platforms only inside the structures, where the thickness of cryogenic beds proved to be smaller than that of the fresh-water zone. The Yakutian basin is the most representative example in this respect. The thickness of frozen rock or soil beds in second- or third-order topographic lows attains here 600 m, while the thickness of the fresh-water zone is in excess of 1000 m. This is the greatest thickness determined with confidence for a cryogenic aquiclude. The detailed hydrochemical investigations carried out by R.S. Kononova, made it possible to identify within the basin horizons marked by cryogenic concentration or cryogenic desalination of underground water. The chemical composition of the groundwater, the significant deficit of formational pressure, as well as results from detailed geothermal studies evidence that the degradation of frozen beds proceeds from the bottom up (Balobaev et al., 1973).

In the northern part of the zone there has been segregated a territory (a subzone), within the confines of which cryogenic beds (dating back largely to the Upper Pleistocene) occur below the sea level (Figure 2, A<sub>2</sub>). These beds occupy a portion of the firm land vacated by the sea in the latter half of the Upper Pleistocene. During that epoch, as the sea retreated, there formed under subaerial conditions cryogenic aquicludes, and an active process of cryometamorphism took place in the sea water entrapped in cracks and interstices of soil and rock. As a result of the advance of the sea, which began 18 - 17 thousand years ago, the long-term process of freezing discontinued in the soil materials as the land gradually subsided below the sea level, and the ice filling the cracks and interstices in the soil and rock, gradually became replaced by sea water at below-zero temperatures.

At the present time the cryogenic beds developed on the territory of that subzone are predominantly of the second, fourth and sixth type. So far their distribution has been studied inadequately. Cryogenic Pleistocene beds of the second type, which recently subsided beneath the sea, persist

alongside the above beds in shallow coastal areas of the East-Siberian sea. According to the data of N.F. Grigor'ev, the overlying frozen earth materials have a low temperature (as low as  $-12^{\circ}\text{C}$ ). The difference in the texture and structure of the cryogenic beds within the confines of the shelf reflect different stages of the metamorphism occurring under the effect of sea water in the cryogenic beds formed under subaerial conditions.

The southern zone of long-term cryometamorphism in soils and rocks is located south of the line of junction of the Pleistocene and Upper Holocene cryogenic beds (Figure 2, B). Inside this zone geothermal and hydrogeological regimes underwent repeated and substantial changes in the course of the Quaternary period.

Cryogenic aquicludes developed within its structures during the cold epochs and persisted for long periods of time. These aquicludes cardinally altered the hydrogeological nature of groundwater basins: the conditions of groundwater recharge, flow and runoff changed; the depth at which groundwater occurred, increased as depending on the thickness of frozen soils or rocks; and fresh-water resources diminished. In the process of freezing of water-bearing soils and rocks a portion of fresh water was fixed in the form of ice inclusions. The bulk of fresh water was, however, squeezed out into the underlying aquifers. Having added to the thickness of the fresh- and brackish-water zone, it then outflowed on the surface through taliks providing an outlet for water. As a result of this not only the chemical composition of the groundwater, but even the pattern of hydrochemical zoning altered in some of the structures.

In the course of the warm epochs the cryogenic aquicludes degraded partly or completely, but the former hydrogeological environment never became completely re-established in these basins, since the water-bearing soils and rocks, as well as the composition of the groundwater itself had undergone qualitative transformations as a result of cryometamorphism.

The effect of cryometamorphism of earth materials on the conditions of formation of underground water in the Southern zone was highly non-uniform, but generally less significant than that in the Northern zone.

The intrazonal non-uniformity of cryogenic changes in the hydrogeological environment was determined mainly by the conditions under which this process developed: the Upper Pleistocene was the epoch of the most extensive distribution of low-temperature cryogenic aquicludes; the early half of the Holocene was the epoch marked by the maximum degradation of cryogenic aquicludes; while the latter half of the Holocene was the epoch, during which there developed new high-temperature cryogenic aquicludes. With regard to the conditions of development of long-term cryometamorphism of soils and rocks in the Upper Holocene and at present, the Southern zone breaks up fairly distinctly into two parts with the boundary-line extending along the southern boundary of the modern cryogenic region. In the northern part of the zone, within the confines of the present-day cryogenic region (Figure 2, B<sub>1</sub>), the processes of long-term cryometamorphism of soils and rocks developed throughout the Pleistocene and Holocene, in its southern part (B<sub>2</sub>) - only during the Pleistocene.

Within the boundaries of the modern cryogenic region, on the territory of the Southern zone, there have now been found cryogenic aquicludes differing in age. This is due to the fact that after the partial degradation of the Pleistocene cryogenic beds represented by the first or second type, during the latter half of the Holocene there formed here once again cryogenic beds of the first type.

High-temperature (up to  $-0.5^{\circ}\text{C}$ ) cryogenic aquicludes of the Pleistocene age have so far been detected only in the Pechora and West Siberian basins\*. In the northern part of the zone they are separated from the base of the Upper Holocene cryogenic aquicludes by a horizon of thawed out rocks. Along the southern periphery of the cryogenic region the roof of relic cryogenic aquicludes lies at the depth of 100 - 200 m from the surface (Figure 2, B<sub>1</sub><sup>II</sup>). The part played by cryogenic aquicludes of the Pleistocene age in the formation of groundwater remains virtually obscure, since the information available on their distribution and thickness is limited.

---

\* In the southern part of the Tunguska basin they have been established tentatively proceeding from analyses of the history of development of cryogenic beds (Fotiev et al., 1974).

In the Upper Holocene the processes of long-term cryometamorphism of earth materials developed over fairly large areas of the Southern zone under relatively mild climatic conditions. These conditions are primarily responsible for the zonal increase in the thickness of the cryogenic beds from a few metres in the south to 100 m (rarely more) in the north. Cryometamorphism of soils and rocks was not an all-embracing process, since in the course of thermal interaction of natural water with freezing soils or rocks there formed open taliks of the hydrogenetic class in all the elements of the relief. N.N. Romanovskii and A.B. Chizhov established in their works the vitally important role played by rain water as the agent determining the degree of discontinuity of cryogenic beds. These researchers also demonstrated a certain dependence of the conditions under which the processes of long-term freezing of rocks develop, on the presence or absence of conditions favourable for infiltration of rain water, particularly in interfluves. Depending on the conditions of infiltration of rain water, there became segregated territories, where long-term cryometamorphism developed practically everywhere, and those, where it developed in isolated massifs or only at localized sites thus giving rise to the continuous, discontinuous or sporadic (islands) distribution of cryogenic beds.

The territory marked by the presence of continuous cryogenic beds (Figure 2, B<sub>1</sub><sup>1</sup>), is confined exclusively to the mountainous regions of the Southern zone (the mountains of the Trans-Baikal region, Southern Siberia, etc.). This is the only territory, where, due to the specific altitudinal-zonal pattern of heat exchange between the earth materials and the atmosphere, the Upper Pleistocene geocryological environment did not undergo significant changes at the time of the thermal maximum in the Holocene. As a result of this cryogenic aquicludes have persisted here for tens or hundred of thousands of years, as is also the case on the territory of the Northern zone. They cover over 95% of the area and have a tremendous impact on the formation and distribution of groundwater within the basins.

The territory marked by a discontinuous occurrence of cryogenic beds, occupies close to 27% of the surface area in the present-day subaerial cryogenic region (Figure 2, B<sub>1</sub><sup>2</sup>). Relatively mild climatic and geocryological conditions in conjunction with large amounts (300 - 400 mm) of rain water and



with the increased jointing arising in water-containing soils and rocks as a result of their repeated cryogenic disintegration, have predetermined the development of numerous water-absorbing or water-releasing taliks. The modern cryogenic aquicludes have been in continuous existence for tens, hundreds, less often even thousands of years and cover 95 to 5% of the surface area, as depending on the water-permeability of the soil or rock in question and on conditions of infiltration of rain waters. This is the factor explaining the spatial (territorial) non-uniformity of the effect of long-term cryometamorphism on the conditions of groundwater formation in different structures. The significant degree of discontinuity and the small thickness of cryogenic aquicludes in on all the elements of the relief induce an active water exchange and make it possible for fresh water to occur inside the structures.

The territory marked by the distribution of cryogenic beds in the form of islands, occupies approximately 12% of the surface area of the modern subaerial cryogenic region (Figure 2, B<sub>1</sub><sup>3</sup>). Cryogenic beds measuring 10 - 25 m in thickness, occur here in the form of isolated islands which are confined to shaded sites and consist of poor filtering deposits. Cryogenic aquicludes generally coincide in this territory with lithological aquicludes. The modern long-term cryometamorphism of soils and rocks therefore plays here a negligible part in groundwater formation.

On the territory south of the boundary of the present-day cryogenic region, located mainly in the Russian and West Siberian Platforms, the process of long-term cryometamorphism of earth materials developed only during the Pleistocene (Figure 2, B<sub>2</sub>). For the time being the nearly total lack of specific information on the main characteristics of cryogenic beds during the different Pleistocene epochs of climatic warming or cooling, makes it impossible to assess the role of the processes of long-term cryometamorphism of soils and rocks in the formation of today's hydrogeological environment inside different structures. It can be merely assumed that the thickness and stability in time of cryogenic aquicludes increased on the territory of the platform in the northern direction. It may be inferred from the extensive development of pseudomorphs in wedge ice that in the central part of the Russian Platform and in the south of Western

Siberia the temperature of earth materials during the Upper Pleistocene may have been as high as  $-3^{\circ}\text{C}$  and the thickness of cryogenic beds was of the order of 100 - 300 m. It may therefore be asserted that cryogenic metamorphism of earth materials and groundwater did not pass without leaving any traces. Inside the structures there may have or, indeed, have perhaps persisted local zones with increased contents of water in soils and rocks due to the cryogenic jointing of these earth materials, or azonal horizons of cryometamorphosed water (horizons of cryogenic concentration or desalination), but the cryogenic origin of these anomalies has simply been ignored. These symptoms of cryogenic metamorphism have been found increasingly more often in earth materials and in groundwater from the territory of the present-day cryogenic region, particularly in the structures, where the beds of frozen soils or rocks have been degraded from the bottom up.

The zone of seasonal cryometamorphism of earth materials is located south of the boundary of the Upper Pleistocene cryogenic region\* (Figure 2, B). During the Pleistocene and Holocene seasonal cryogenic metamorphism prevailed on the territory of that zone penetrating to the depth of 5 - 10 m. Long-term cryometamorphism of earth materials was characteristic only of high mountains. Its intensity varied with altitude during the cold and warm epochs of the Quaternary period. At the present time the processes of long-term cryometamorphism of earth materials are in progress within the Glavnyi (Principal) range in the Caucasus at absolute altitudes of over 3 - 3.5 thousand metres.

To assess more fully the effect of cryogenic metamorphism of soils and rocks on conditions of groundwater formation, we are thus proposing a new scheme for sequential hydrogeocryological regionation of the territory of the U.S.S.R., with new taxonomic units, i.e., hydrogeocryological zones and subzones, and, within the confines of the latter, of hydrogeocryological provinces.

---

\* Once the territory of this zone has been studied in greater detail from paleogeocryological positions, we may find here, too, signs of long-term cryometamorphism of soils and rocks.

REFERENCES

1. BELOBAEV V.T., DEVYATKIN V.N. and KUTASOV I.M. Sovremennye geotermicheskie usloviya sushchestvovaniya i razvitiya mnogoletnemerzlykh gornykh porod. (Modern geothermal conditions of occurrence and development of permafrost). - V kn.: II Mezhdunar. konf. po Merzlotovedeniyu (IN: II International Conference on Permafrost). Dokl. i soobshch., Issue 1, Yakutsk, pp. 11-19, 1973.
2. VELICHKO A.A. Prirodnyy protsess v pleistotsene (Natural processes in the Pleistocene). Moscow, "Nauka", 256 pages, 1973.
3. KONONOVA R.S. Kriogennaya metamorfizatsiya podmerzlotnykh vod Vostochno-Sibirskoi artezianskoi oblasti (Cryogenic metamorphism of subpermafrost water in the East Siberian artesian region). "Sov. geologiya", No. 3, pp. 103-115, 1974.
4. MEL'NIKOV P.I. O glubine promerzaniya verkhnei zony zemnoi kory na territorii Ya ASSR (The depth of freezing in the upper zone of the earth's crust on the territory of the Yakutian ASSR). V kn.: Geotermicheskie issledovaniya i ispol'zovanie tepla Zemli. Moscow, "Nauka", pp. 110-118, 1966.
5. NEIZVESTNOV Ya.V., OBIDIN N.I., TOLSTIKHIN N.I. and TOLSTIKHIN O.N. Gidrogeologicheskoe raionirovanie i gidrogeologicheskie usloviya sovetskogo sektora Arktiki (Hydrogeological regionation and hydrogeological conditions in the Soviet section of the Arctic regions). V kn.: Geologiya i poleznye iskopaemye severa Sibirskoi platformy. Leningrad, pp. 92-105, 1971.
6. Podzemnye vody Yakutii, kak istochnik vodosnabzheniya (Subterranean waters in Yakutia as a source of water supply). Moscow, "Nauka", 111 pages, 1967.
7. FOTIEV S.M. Usloviya formirovaniya i zakonomernosti rasprostraneniya razlichnykh tipov kriogennoi tolshchi na territorii SSSR. (Conditions of formation and distribution patterns of different types of cryogenic beds on the territory of the U.S.S.R.). Trudy PNIIS, vyp. 36, Moscow, Stroizdat, pp. 135-146, 1975.
8. FOTIEV S.M., DANILOVA N.S. and SHEVELEVA N.S. Geokriologicheskie usloviya Srednei Sibiri (Geocryological conditions in Central Siberia). Moscow, "Nauka", 146 pages, 1974.

LONG TERM DYNAMICS OF GROUNDWATER ICINGS

N.N. Romanovskii and V.E. Afanasenko

Moscow State University

M.M. Koreisha

Industrial and Research Institute for Engineering Surveys in Construction

Moscow, U.S.S.R.

In recent years, as a result of complex, permafrost and hydrogeological surveys and special research projects, a large amount of material has been obtained which bears evidence of the intense perennial and centuries old dynamics of groundwater icings, especially of deep subpermafrost drainage. Individual occurrences of icings appearing and disappearing, shifting up or down along valleys, changing in form, dimension and volume of constituent ice (ice comprising the icing) were known earlier. However, the scale of the perennial dynamics of icings and the geological effects of their activity turned out to be immense and surpassed even the boldest expectations. Vast territories, restricted to the tectonic intermontane basins of the Verkhoyana-Kolyma fold mountain region, the north of the Baikal mountain region, and the river valleys in the mountain massifs of the Cherskii, Selennyakh, Suntar-Kayata ranges, the Buordakhskii Massif, the Stanovoe Upland, etc., have been fashioned by icings. The surface of the tectonic depressions are systems of flat sites of annual appearance of icings, frequently not associated with the river valleys. A number of sites are covered by icings every year, others are relic forms. River valleys having groundwater icings in the valley floor are of a distinct shape, where widening corresponds to sites of icings.

Geological activity of icings leads, on the one hand, to erosion of the sides and a widening of the valley floor: on the other hand, to the

erosion and removal of fine-grained, supes-suglinok\* floodplain deposits beneath the icings. In addition, deposits of sand, gravel, and pebbles form streams, glaciers and meltwater, and slope deposits of gravelly rock debris are exposed at the surface. The mechanics of the action of icings have been investigated by P.F. Shvetsov and V.P. Sedov, S.M. Fotiev, N.N. Romanovskii and others, and therefore will not be examined in this paper. We will concentrate on the fact that the product of icing activity, the so-called "icing alluvium" is a high quality material for roadbeds and a good foundation for buildings, and that the dry surfaces of ancient icing sites are very suitable for various types of construction. However, conditions for any kind of economic activity immediately in the zone of icing formation are extremely unfavourable. Therefore, the study of the causes and patterns of migration of icings is of great theoretical and practical interest.

Research into various types of hydrologic textures, which have, to varying degrees, been changed by deep perennial freezing and have differing distributions of waterbearing taliks, showed that the special features of their formation, regime and perennial variability of their icings are, on the one hand, associated with the type of water forming the icings, and on the other hand, with the nature of the taliks, their genetic features, their dimensions, form, and the interrelationship of the various categories of taliks in plan and in section. We will reveal this situation through the example of groundwater icings of deep subpermafrost drainage which discharges through open taliks (Figure 1). The most complete analysis of the patterns of the dynamics was achieved for very large icings of a given origin (Romanovskii et al., 1973).

An extreme example of the interrelationship between talik and icing is the development of the latter above groundwater springs that discharge through hydrogeogenous open taliks. The condition for this is the development of low temperature permafrost and a severe climate. The spring issues from the centre of the icing forming a dome above the outlet, in the centre of which is a hydrolaccolith (Figure 1-I). Such an icing was

---

\* Supes - silty sand with some clay, sandy silty loam.  
Suglinok - clayey silt with some sand, clayey silty loam - Transl.).

Figure 1

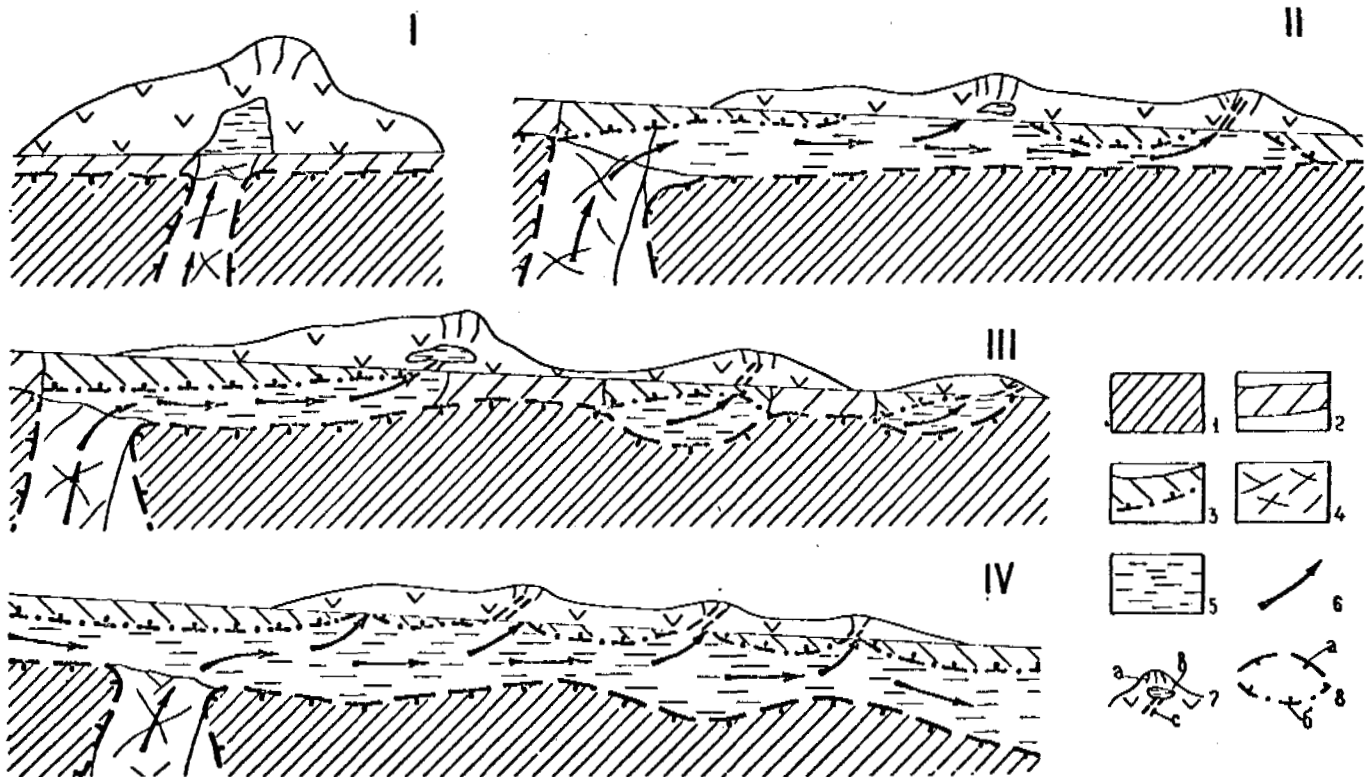

Diagram of the relationship between groundwater icings and water-bearing taliks.

1 - permafrost; 2 - layer of seasonal thawing; 3 - layer of seasonal freezing; 4 - open talik in fissured bedrock; 5 - seepage talik; 6 - direction of groundwater movement; 7 - icings: A) channels in the body of the icing through which water issues; B) water lenses; C) fissures in the hydrolaccoliths; 8 - permafrost boundary (a) and layer of seasonal freezing - thawing (b).

discovered under the so-called "Lake Gusinoe" in the Selennyakh depression and was studied (Romanovskii et al., 1974) in conditions of thick low temperature permafrost ( $t_{av}$   $-5, -7^{\circ}\text{C}$ ). The diameter of the talik is only a few metres at the surface. The maximum summer discharge was 66 l/sec when the surface water temperature at the outlet was  $+0.2^{\circ}\text{C}$ . At the end of the winter, it had apparently decreased to from 10 to 12 l/sec. In the winter months, these icings protect the earth materials of the talik from freezing. The water emerges onto the surface of the icing through the fissures in the hydrolaccolith. When springs are ceasing to function at the end of winter and starting up again in spring, the icings covering them facilitate a speedy

upward breakthrough of water, because of the melting from top to bottom of the ice constituting the icing, erosion, seepage through the fissures, etc.

When the regime of the groundwater spring persists year after year, the quantity of ice forming the icing in winter remains virtually constant. Changes in the volume of the icing are dependent only on the amount of ice that does not melt in the summer. On the whole, there is little change in the form of the icing.

Usually, in severe permafrost conditions, a seepage talik of earth materials exists below hydrogeogenous or underwater taliks (infrabed, flood plain, etc.). Before issuing at the surface to form an icing, some of the water from the deep discharge passes through the seepage talik of unfrozen ground. Therefore, it is as if the latter distributes the groundwater over the area of icing formation. The special features of the icing and the nature of change in its parameters in the perennial system are decisively dependent on the position, dimensions, and extent of the seepage talik.

There are two basic types of occurrence: - when the seepage talik is closed and extends into the seasonally thawed layer which freezes completely in winter (Figure 1-I), and when an open or closed seepage talik extends as an uninterrupted strip increasing downwards through the section (Figure 1-IV). There is a transitional occurrence: this is when a seepage talik separates in winter into a system of isolated taliks where there are limited static reserves of water and a stagnant regime. Because of these, only small icings can form (Figure 1-III).

If there are uninterrupted seepage taliks, open or closed, then the dimensions and form of the icing body and the volume of constituent ice will vary considerably from year to year, and are strongly dependent on the climatic conditions of the winter. In a severe winter with little snow, when the seasonal freezing reaches its perennial maximum and the flow in the seepage talik becomes very little, much of the groundwater issues at the surface and forms large icings in winter. In contrast, in a mild winter with a large snowfall, the seasonal freezing of the earth materials is not great, consequently, the sections of the taliks are not greatly reduced and a small

amount of the water goes into the formation of icings. In such years, either the dimensions of the taliks are minimal or taliks do not form at all.

In the occurrence being studied, all the parameters of the icings change every year and there is a clear connection between these changes and fluctuations in climate.

In another occurrence, where water from the deep subpermafrost discharges from the "blind" seepage talik and is present below the outlet to the surface, virtually the same amount of groundwater is used in the formation of icings. The differences from year to year are not usually greater than the errors in measurements of the volume of ice comprising the icings. They are mainly connected with the fact that in autumn, some of the water below the seepage talik manages to flow out along the layer of seasonal thawing. Depending on the length of time from the beginning to the end of the thawing of this layer, the amount of water issuing from the volume of ice can also be associated with changes in the periods when the icings cease growing in spring.

In the occurrence being analysed there can be very considerable changes in form and location; these changes are of a periodic nature. This is mainly associated with two conditions. First, with displacement, the sideways migration of seepage taliks, and their fragmentation; secondly with a change in their length. The latter process is, to a considerable degree, long-term cyclic (self-fluctuating) in character.

Figure 2 is a diagram of the perennial dynamics of the Oisordookh icing in the Selennyak basin in the Northeast U.S.S.R. It was first investigated in 1939 by P.F. Shvetsov and V.P. Sedov (1941), and again by them jointly in May-June 1972. The supplementary use of aerial photographs over a number of years made it possible to establish that there are constant changes in the location of the body of the icing, the point of thickest ice in different years, and the position of channels in the ice above the seepage talik. We must add that, according to the data of A.S. Simakov and Z.G. Shil'nikovskaya, on the 1951 photographs, there was no ice at the icing site. Considering the fact that from 2.5 - 3 to 3.5 - 4 m of ice melts during the



summer in this region, it can be taken that in 1951, the thickness of the icing did not exceed 4 m. In 1972, the ice at the central part of the icing reached a thickness of 6 - 8 m, i.e., an icing of this thickness can thaw in 2 - 3 years, if there is no further growth of ice in the winter. The area of the icing was 5.85 km<sup>2</sup> in 1939, and in 1972 it was 8.55 km<sup>2</sup>, i.e., there was an increase of approximately 30%. Periodically, a so-called "icing tongue" appears under the main body of the icing and disappears again; it extends for up to 10 - 12 km along the Oisordookh valley. All indications are, that a massive groundwater icing of deep subpermafrost discharge existing in very severe permafrost and climatic conditions is very dynamic in character; it also indicates that perennial icings can periodically turn into annual icings.

Figure 2

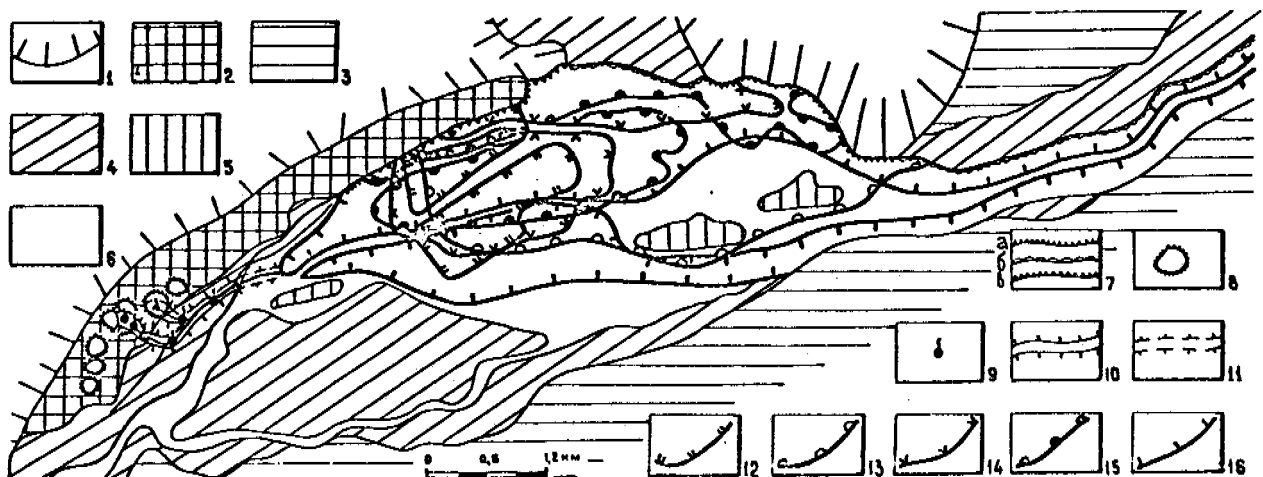

Schema of the Oisordookh icing.

1 - Upland slopes composed of bedrock 2 - high terrace above floodplain; composed of supes-suglinok deposits with syngenetic ice wedges; 3 - alluvial surface of a very high ancient icing site; 4 - alluvial surface of a lower, young icing site; 5 - high "islands" on the surface of a present day icing site filled with depressed vegetation; 6 - surface of present day site, no vegetation, composed of sandy-gravelly-pebbly deposits; 7 - scarps eroded by icing; a - bedrock slope; b - "ancient" icing sites; c - high terraces above the floodplain; 8 - thermally eroded depressions; 9 - rising groundwater springs; 10 - boundary of hydrogeogenous open talik; 11 - boundary of infrabed seepage talik; 12-16 - boundaries of icing ice; 12 - in 1951 (date unknown); 13 - mid-June 1939; 14 - 9 July 1965; 15 - 11 July 1964; 16 - 20 July 1972.

Direct and indirect (according to growth) observations of many massive groundwater icings in the Northeast U.S.S.R. show that the lower parts of the icings periodically shift up and down the valley floor, and that "icing tongues" appear and disappear. This is associated with changes in length of the seepage talik during interaction with the icing. This process is essentially as follows. Under the body of an icing 5 - 8 m thick, both surface and groundwater are considerably protected from frost action. Due to the retarded action of heat loss, the moving water is able to issue from the discharge location over a considerable distance. In summer, when there is fragmentation and thawing of the seepage talik under the water course, the flow increases in length. In the perennial ice of an icing, above the talik, a tunnel develops, followed by a "canal". In autumn, the "canal" is the first to fill with ice, protecting the water flow from frost action. A series of hydrolaccoliths form along the "canal" through which there is an outpouring of water onto the surface (Figure 3-I). Secondary canals and tunnels branch off from the main canal, distributing the water from the icing - forming surface. Just as the talik increased in length during the summer, so the icing correspondingly starts to extend along the valley (Figure 3-II). In subsequent years, sustained direction of this advance leads to the development of an "icing tongue" below the main body of the icing, and to a decrease in intensity of icing formation in the latter. This, in turn, determines the general increase in area and the decrease in thickness of the icing (Figure 3-III). Finally, the thickness of the ice becomes such that it thaws either completely, or to a considerable degree. Consequently, the protective influence of the "canals" in the icing disappears. When there is a flat icing site devoid of ice, the surface water flow and then the seepage talik itself fragment into several branches. As a result, in autumn, the water in the shallow braided water courses and in the shallow closed seepage taliks below the numerous streams, quickly chill and freeze, forming a concentrated, often dome shaped icing near the groundwater surface outlet (Figure 3-IV). The seepage talik below the main body of the icing is no longer fed with groundwater. It now falls into the system of isolated taliks and then freezes. Icings no longer form where the talik once existed. After the formation of the dome shaped icing the fragmented water courses and the shallow seepage talik become concentrated into a single course and a single talik. Associated with this is the fact that in winter, in "blind" water

courses and taliks, the flow ceases when the icing is sufficiently thick. Due to their small volume, the water pressure is not great enough to break through the very strong ice and form a hydrolaccolith through which water would issue to the surface. Consequently, the stagnant water in the talik and canals in the ice freeze, and the water flow is directed to the main stream. A series of large hydrolaccoliths form along the stream and, in winter, especially in the second half, ice formation starts again. Later, the main stream and the talik beneath it increase in length, and the cycle is repeated.

Figure 3

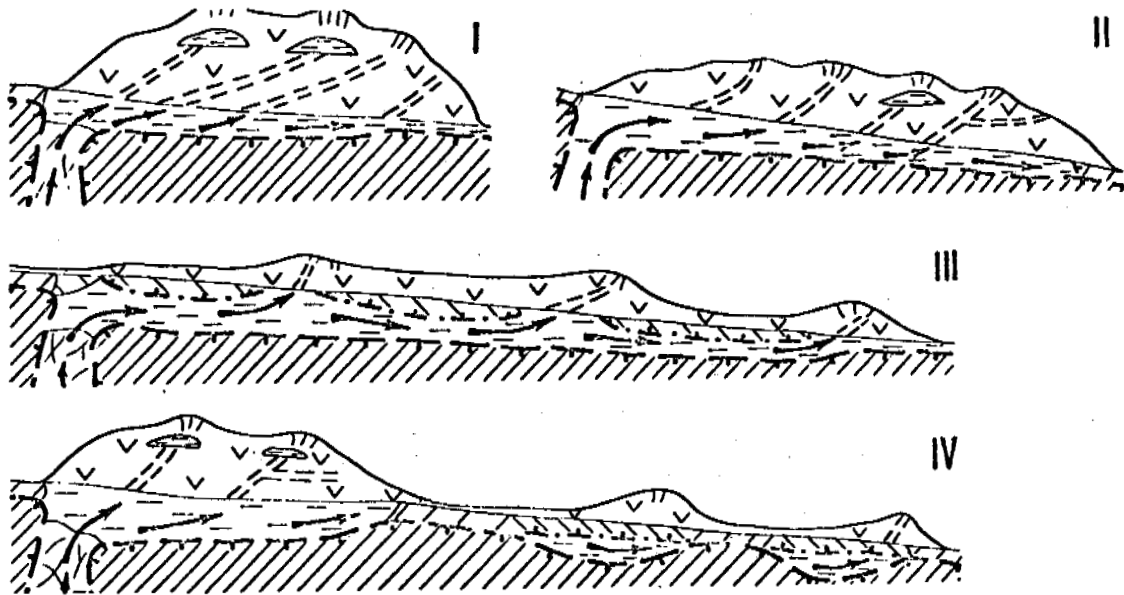

Diagram of perennial changes in length of a seepage talik and a groundwater icing in severe permafrost and climate conditions.  
Legend as in Figure 1.

Such cyclic (self-fluctuating) changes in dimension and form of large groundwater icings lead to their periodic transition from perennial to annual icings and vice versa. A distinction must be made between perennial and annual icings, and the intermediate type, that is, the summer icings and corresponding stages of development of the very same groundwater icing for the specific character of its relationship with the water bearing taliks.

Naturally, even such a renowned icing as the "Moma", one of the largest in the world, undergoes considerable perennial changes; this is probably reflected in the observable discrepancies in estimates of its area in the various sources: from 76 to 112 km<sup>2</sup>. In any case, it is known that in some years a large area of this icing remains all summer, in other years, it has virtually melted completely by August (Yakovlev, Koreisha, 1973). The self fluctuating nature of the changes in form and area of the icing in a severe climate is in itself not connected with its perennial fluctuations. Without doubt, perennial fluctuations of the mean annual temperatures, amplitudes of changes in temperature during the year, the thicknesses of snow cover, etc., have an influence on the continuity of the development cycles of icings, the continuity of stages within the cycles, etc. They can deform the cyclic (self fluctuating) nature of the development, but they cannot change it in essence. For radical changes, there would have to be a profound change in the permafrost conditions.

The periodic changes of location of the distributing taliks finally leads to an increase in the dimensions of the icing sites compared to the dimensions of the icings themselves.

As well as the periodic changes, there are in nature, well known, induced changes. In our case, these include both the appearance and the disappearance of taliks which discharge water onto the surface, and also directed shifts in location of taliks. The fact that open taliks and the icings associated with them can cease to exist has been known for a long time (Springis, 1961). It was also revealed by the authors when they were researching the junction of the Kyra and Nekharanskies icings in the Selennyakh basin (Figure 4). Thus, in 1972, the "Upper" groundwater spring, which had issued through the hydrogeogenous open talik beneath the riverside bedrock scarp of the Kyra above Mt. At-Khayaand that fed the Upper Kyra icing, was no longer in existence (Shvetsov, Sedov, 1941). In the past, the spring had a discharge rate of 340 l/hr. At the present time, all that remains are shingle filled depressions where the water used to emerge, and a dry stream bed.

Reformation of open taliks has only been ascertained in recent years. Thus, the talik that formed the "Lake Gusinoe" icing (cf. Figure 4), appeared very recently at the location of the small lake "Gusinoe" described by P.F. Shvetsov and V.P. Sedov in 1939.

Figure 4

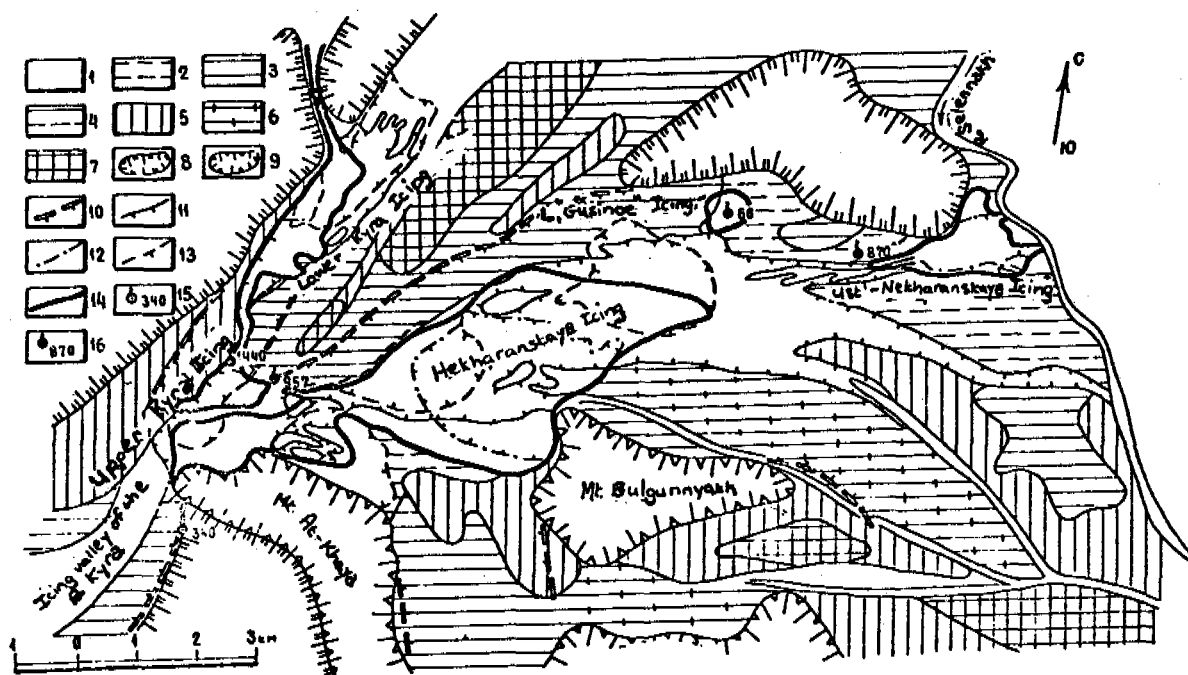

Diagram of the Kyra-Nekharanskii icing junction.

Upper Quaternary and present day alluvial surfaces which were exposed to the action of icings at various times; 2 - lower terraces with fresh traces of icing action, but not now covered with ice; 3 - terraces with distinct traces of the icing forming processes within which secondary processes are actively developed; 4 - surfaces transitional between 2 & 3 in character; 5 - surfaces with traces of shaping by icings, sharply attenuated secondary processes; 6 - surfaces transitional between 3 & 5; 7 - high surfaces with weak traces of former icing forming processes; 8 - Upper Quaternary depositions of an "ancient" alluvial plain with syngenetic wedge ice; 9 - surfaces composed of Jurassic bedrock. Boundaries of icings in various years; 10 - December 1868 (according to Maidel'); 11 - May 1939 (according to Shvetsov & Sedov); 12 - 11 July 1964; 13 - 5 July 1970; 14 - 18 May 1972. Groundwater springs from deep discharge, and their yield; 15 - those no longer extant; 16 - existing icings.

Recently, no longer than 100 years ago, a hydrogeogenous open talik appeared on the valley slope of the rivulet "Veshchego", the right tributary of the Ulakhan-Kyuegyulyuyur, in the northern part of the Kular

Range (Afanasenko et al., 1973). The talik, which has the form of a truncated cone, appeared at the point of intersection of two large faults which run in a northwesterly and northeasterly direction. The thickness of the permafrost surrounding the talik reaches 380 - 400 m, decreasing to 150 - 200 m within the icing site. The volume of water from the springs is 12 - 15 l/hr and the volume of ice attains 340 m<sup>3</sup>. The icing site below the spring is covered with the remains of trees which were growing there prior to the formation of the talik and the icings. Both of the above mentioned regions have high seismicity (up to 8 degrees). Apparently, the groundwater broke through as a result of an earthquake shock, causing a hydraulic thrust. Reformation of open taliks has also been confirmed in the region of the Stanovoe Upland, where there are known to be earthquakes of up to 10 degrees.

Induced changes of location of taliks has been established in many regions of the Northeast U.S.S.R., especially within the superimposed Cenozoic tectonic depressions such as the Uyandinskaya, Moma-Selennyakh depressions, etc. Underwater and hydrogeogenous open taliks restricted to the fracturing tectonic disturbances bounding the depressions and dissecting its folded cover, are constantly shifting, mainly along the faults. Recent tectonic movement seems to be the cause of this shifting; it apparently brings about changes in the permeability to water of the earth materials in various parts of the talik. As a result, the rising water in the permafrost thaws one of the walls of the talik and there is a corresponding freezing of that part of the talik where movement of water has ceased. When an icing shifts, then so does the talik, leaving behind it a stretch of terraced icing sites.

Several of the mountainous regions of the Northeast and of Zabaikal'e serve as examples of individual directed developments and shifts of icings. Here, during degradation in the Upper Pleistocene Ice Age, icings occupied the "U" shaped valleys which were being freed of glaciers. Directed evolution of icings is very closely connected with the evolution of glaciation.

Glacial troughs in regions of recent Upper Pleistocene glaciation undergo strong and highly individual shaping by icings. Very frequently,

icings and icing sites are found in glaciated areas of valleys situated above the moraine and rock bar complexes and are filled with layers of coarse granular deposits from glaciers and meltwater. Along the periphery of mountainous structures, icing sites are either relic or have present day icings covering a very small part of them. On the other hand, in the middle and upper regions of the glacial troughs, icings are forming at the present time, many of which completely fill the valley floor and lead to their widening (Nekrasov et al., 1976).

The scales of icing migration, under the influence of both induced and cyclic changes, are represented in Figure 4. Here, not only are present day perennial shifts of icing sites apparent, but so is a whole series of various more ancient sites.

Research into the perennial dynamics of groundwater icings has convinced us that the theory of long term forecasting of icing formations for various practical engineering problems is very necessary for concrete estimates of corresponding processes and phenomena: primarily the peculiarities of its cyclic nature (self-fluctuation) and the induced evolution of icings. Also, paleographic reconstruction of the nature of regions with icing development cannot be sufficiently complete and reliable without consideration of the dynamics of icings, and their geological and landscape-forming action.

#### REFERENCES

- AFANASENKO V.E., BULDOVICH S.N. and ROMANOVSKII N.N. O proyavleniyakh mineral'nykh vod v severnoi chasti Kularskogo khrebta. (Occurrence of mineral waters in the southern part of the Kularskii Range). - Byull. MOIP, otd. geol. Vol. X/XI (6), pp. 91-102, 1973.
- NEKRASOV I.A., ROMANOVSKII N.N., KLIMOVSKII I.V. and SHEINKMAN V.S. Rol'naledei v morfologii lednikovyykh dolin khrebta Cherskogo. (Role of icings in the morphology of glacial valleys in the Cherskii Range). - In the book: Gidrogeologicheskie issledovaniya kriolitozony (Hydrogeological research of the permafrost zone). Yakutsk, pp. 83-92, 1976.

- ROMANOVSKII N.N., AFANASENKO V.E. and KOREISHA M.M. Dinamika i geologicheskaya deyatel'nost' gigantskikh naledei Selennyakhskoi tektonicheskoi vpadiny. (Dynamics and geological activity of the icings in the Selennyakh Depression). - Vestn. MGU. Ser. geol. No. 6, pp. 52-74, 1973.
- ROMANOVSKII N.N., AFANASENKO V.E. and KOREISHA M.M. Naled' Ozero Gusinoe". (The Lake Gusinoe" icing). In the book: Merzlotnoe issledovaniya vyp. 14. (Permafrost Research, No. 14), Izd-vo MGU, pp. 105-108, 1974.
- SPRINGIS K.Ya. Nekotorye priznaki proyavleniya tektonicheskikh dvizhenii v Verkhoyano-Kolyskoi skladchatoi oblasti. (Some indications of tectonic activity in the Verkhoyana-Kolyma folded region). - In the book: Neotktonika SSSR. (Neotectonics of the U.S.S.R.) Riga, Izd-vo AN Latv. SSR, pp. 223-229, 1961.
- SHVETSOV P.F. and SEDOV V.P. Gigantskie naledi i podzemnye vody khrebta Tas-Khayakhtakh. (Massive icings and groundwater of the Tas-Khayatakh Range). M., Izd-vo AN SSSR, 81 pages, 1941.
- YAKOVLEV O.N. and KOREISHA M.M. Merzlotno-gidrogeologicheskoe issledovaniya v raione Momo-Zyryanskoi nalozhennoi vpadiny. (Permafrost-hydrogeological research in the Moma-Zyryanka superimposed basin). In the book: Inzhenernyye izyskaniya v stroitel'stve, Ser. II. Geokriologicheskoe issledovaniya, vyp. 7 (25). (Engineering surveys in civil engineering, ser. II Geocryological Research, No. 7 (25), pp. 34-37, 1973.





## THE ROLE OF TECTONICS IN THE FORMATION OF PERMAFROST ON LOW PLAINS

V.V. Baulin, E.B. Belopukhova, N.S. Danilova,

G.I. Dubikov and A.Ya. Stremyakov

Industrial and Research Institute of Engineering Surveys in Construction,  
Moscow, U.S.S.R.

In recent years, the effect of tectonics on permafrost, permafrost processes, and frozen ground features has attracted the attention of many Soviet researchers. This effect is examined in many studies devoted to the problems of engineering geology as a whole, and to the study of permafrost in particular. The most clearly defined position concerning the interreaction of tectonics with the earth's surface was formulated by I.V. Popov (1961): "All exogenic processes are, to one degree or another, controlled by endogenic processes". This is one of the basic positions in morphostructural analysis (Gerasimov, 1970). The effect of tectonics on permafrost was first observed by P.F. Shvetsov, A.I. Kalabin and N.I. Tolstikhin with regard to mountainous regions, where it is exhibited most clearly and is reflected in the landscape.

Almost everyone engaged in research into permafrost on low plains has also noted the important significance of tectonics in the formation of permafrost as a whole, in the development of the cryogenic processes and of their individual characteristics (Kudryavtsev, 1954; D'yakonov, 1958; A.I. Popov, 1967; Baulin, 1966, 1970; Baulin et al., 1970; Belopukhova, 1971; Belopukhova, Danilova, 1974).

As a result of this research, it has been shown that the tectonic development of a territory, especially in its very recent stage, is a decisive regional factor determining the spatial differentiation of permafrost conditions. It is just this regional effect that determined the type of

permafrost and the complex of frozen ground features on the vast low plains (Western Siberian, Central Yakutia and Kolyma-Indigirka). In this region, the effect of tectonics is of such a magnitude that it greatly disturbs the zonal manifestation of the environmental processes.

When examining the effect of tectonics on the permafrost of low plains, the fluctuating movement of the surface, and the differentiated structural formation and the disturbance of the sedimentary cover should be borne in mind. The effect of tectonics on the permafrost of the region is not exhibited directly but through other factors, including a whole complex of landscape conditions; this sometimes creates certain difficulties for research into this process. Thus, the dependence of the discontinuous nature of permafrost on the tectonics near the southern boundary of their distribution is exhibited through the composition of the earth materials, the moisture at the surface, and the vegetation cover. The effect of each factor on the permafrost is different and depends not only on the manifestation but also on the amplitude of the tectonic movements. Thus, for example, swamping of the surface, in the case of subsidence, and initial growth of a moss cover, can bring about the re-formation of permafrost, and later, when there is excess water, can cause the thawing of permafrost.

A further complication to the study of the problems examined in this paper is the fact that the formation of permafrost took place in the Quaternary and embraced a period of almost a million years. At the same time, even the most recent tectonic stage covers 10 million years. In this case, analysis of the general system of the region's tectonic development is very important. In Western Siberia, for example, the basic features of the tectonic structure lasted throughout the Mesocenozoic; this gives reason for assuming inherited development of a significant part of the local textures (Chochia, 1968) and their one-directional effect on the permafrost. Inherited development of texture has also been established in several regions of the Maritime Arctic Lowland (Velikotskii, 1974).

To date, no sufficiently accurate methods have been worked out for analysis of the tectonic life of the earth's crust for the period of perennial freezing of deposits. Repeated precision levelling of the Earth's surface

(Map of Contemporary Vertical Movements..., 1973)\* is a great help in analyzing the effect of tectonics on permafrost. However, they only take in the regions in the European part of the U.S.S.R. In the past few years, a method has been worked out for revealing the movements of the earth's crust on the basis of comparison of repeated aerial photography at an interval of 10 - 15 years (Orlov, 1975). These data show the strong effect of contemporary movements on permafrost, particularly on high temperature types of permafrost near the southern boundary. In individual cases, it is possible to judge tectonic movements of the earth's surface by the condition of the permafrost and the frozen ground features.

The uneven and inadequate coverage of the problem of interaction of the tectonics and permafrost partly explains a certain degree of schematism in the following presentation of material.

#### DISTRIBUTION AND MEAN ANNUAL TEMPERATURE OF PERMAFROST

The tectonic structure of the territory, and the groundwater associated with it, is one of the strongest factors determining the discontinuous nature of permafrost. Groundwater in zones of tectonic faults determines the existence of taliks, even in the thick, low temperature permafrost of the arctic plains. Within the confines of the inherited Tazovskoe uplift, where the mean zonal temperature of the ground is below  $-4^{\circ}\text{C}$ , there are many closed taliks caused by the dissected relief of this uplift. In the depressions, which are characterized by the evenness of their surface, permafrost is continuous, even when there are high temperatures.

In the southern regions, where high temperature permafrost is developed, the tectonics can predetermine the existence of permafrost over considerable areas.

Thus, in the southern forest zone and the forest-tundra of the European part of the U.S.S.R. and in Western Siberia, the percentage of occurrences of permafrost in regions of tectonic submergences is considerably

---

\* Karta sovremennykh vertikal'nykh dvizhenii..., 1973

higher than in regions of uplifts. This phenomenon is associated with the fact that in regions of submergence, there is considerable peat content at the surface, favouring the existence of permafrost; whereas uplifting is characterized by an increase in forests, and by the existence of thawed ground, typical of forests. In the middle reaches of the Nyd River, in the region of the Medvezh' uplift (West Siberia), owing to the absence of peatland dissected relief, the zone of discontinuous permafrost is shifted no less than 30 - 50 km in the north in comparison with the surrounding terrain.

The mean annual temperature of permafrost is controlled by the tectonics through landscape conditions at the surface (relief, water content, vegetation cover, redistribution of snow).

It is characteristic of tectonic uplifts to have variations in ground temperatures by area that are related to the dissected character of the surface. Thus, in the north of the Tazovskii Peninsula (Yamburgskoe uplift), the difference in temperature throughout the area is approximately  $8^{\circ}$ . On the whole, the mean annual temperature is higher than in the depressions, although in individual areas the ground temperature may be lower.

#### CRYOGENIC STRUCTURE OF PERMAFROST

It is the special features of the tectonic regime and its accompanying sedimentation and denudation processes on low plains that gave rise to the formation of permafrost of various compositions and structures. Marine transgressions, caused by recent movements and fluctuations of the global ocean level, covered the northern extremes of Eurasia for the larger part of the Pleistocene. The various intensities and directivities of the neotectonic movements determined the changeability of the composition and thickness of the unconsolidated deposits, and also their levels of freezing. This furnished a reason for dividing and arranging permafrost into arch type and depression type.

Arch type permafrost of the low plains is inherent in tectonic structures (arches, uplifts, etc.) of the Mesozoic cover. Changes in the lithological facies in the sections of Pleistocene deposits on positive

structures are associated with lag, which occurs when there is a general lowering of terrain: and advance, where there is doming, (Matveeva, Perugin, 1971). In such sections even insignificant fluctuations of sealevel are registered. The sedimentation cycles of polar transgression on positive structures were exhibited in the lithological variety of sediments (facies non-recurrent layers of sands, clayey sediments with intercalations and lenses of coarse gravels). In sections of the arch type, the sands and gravels correspond to the regressive stage of the polar basin. For Pleistocene deposits of the arch type, the following are characteristic: erosion, interruptions in sedimentation, and rapid facies variations of the lithological composition over a short distance. Tectonic structures that are composed of Paleogene and Cretaceous materials downwards from the surface, and which were either stable or dominated by denudation processes for most of the Quaternary, should be regarded as an extreme example of arch type permafrost.

Observations show that in the structure of the permafrost in the most recent positive structures, great variations can be observed in the dependence on the basic directions of development, i.e., denudation or accumulation of sediments.

1. Within the confines of the most recent positive structures of denudation development, epigenetic permafrost with indisputable signs of inundation prior to, and during freezing, is widespread. The upper horizons of the Cretaceous and the Paleogene clayey materials, forming the numerous positive structures of the second and third orders in the north of Western Siberia and the Khatanga Lowland, contain differing quantities of ice and are characterized by a complex cryogenic structure. Since all positive structures in these regions reflect vast disjunctive disturbances in the Paleozoic base and the Mesocenozoic cover, a certain dependence of high ice content of the materials within the structure on the tectonic disturbance and high degree of water encroachment during the period of freezing can be traced. The materials are fractured by a system of fissures in two intersecting directions, through which groundwater would circulate, i.e., along the bedding plane and at an angle to it. The bearing of the fissures in the materials of the Mesocenozoic cover corresponds to the bearings of the tectonic disturbances of the base (Geologicheskoe stroenie/Geological Structure/...., 1968). Through these

fissures, which served as collectors, artesian discharge water would rise to the surface; this water would bring about high ice saturation in the upper horizons of the frozen clayey layers and would form enormous hydrolaccoliths (the sulphate-sodium composition of the ice core points to deep seated water). For as far as the systems of tectonic fissures can be traced within the positive structures over vast areas and have definite orientation, so can a high ice saturation of the materials be traced within positive structures over vast areas with the same orientation. Areas of Pre-Quaternary clayey materials with high ice content appear in the locality as linear ridge landscape forms. Features characteristic of the structure of permafrost clays within the confines of the positive structures of denudation development are: fissured type of cryogenic structures, deformations of ice streaks (faulted or dislocated along the vertical by several centimetres), and extremely high ice content (40 - 60%) above the 40 metre layer, which decreases with depth, although individual thick layers of ice can be traced to 100 m and below.

Within the youngest block structures, which rise rapidly, and among which the Tamansk uplift on the Gydanskii Peninsula can be included, the upper 40 - 50 metre permafrost horizon is composed of fissured sandy clays with a small ice content, and dates to the Cretaceous. It extends as ice saturated (30 - 40%), fissured silica clay and sandy clays with an apparent thickness of 30 m. Ice filled the bedding, fissures, diagenetic fissures and also those at an angle to the bedding. Such a distribution of ice content in the permafrost section is associated with a strongly dissected surface of an uplift, with drainage and desiccation of the upper, most fissured, weathered horizon of materials at the time of freezing. From the surface, to the depth of ancient dissecting of relief by erosion, which, at the moment of freezing, did not exceed 40 - 50 m (owing to the distribution of the ice content), sandy clays were dehydrated. Their freezing led to the formation of an upper horizon with little ice content. Below the depth of erosion, fissured sandy and silica clays froze if the fissures were filled with water. This is how the icy clays were formed, the covering of which is exposed in natural sections 20 - 30 m above the present-day depth of dissection.

2. Within the confines of the positive structures, characterized in the period of Boreal transgression by an accumulation of sediments

variegated in the lithological section, epigenetic and polygenetic permafrost formed. Their structure is variable; in the permafrost sections, materials with high and low ice content alternate. The relationship of these horizons in the section is determined by the presence of clayey and sandy (water bearing, prior to freezing) horizons. Large (thickness to 20 m) layers of stratified ice are inherent in this type of permafrost and are restricted in, the overwhelming majority of cases, to contact with clayey and sandy materials. No kind of pattern of distribution by depth of either clayey, ice horizons or large beds of ice has been established. In Western Siberia, (Bol'shekhetskoe uplift) ice, clayey horizons are exposed by boreholes at various depths from several tens of metres to 100 - 150 m. This is also the case with beds of ground ice that are exposed at depths of from several metres to 100 - 120 m.

Of great interest are permafrost sections of positive structures in the sections of which, a change in the processes of sedimentation and denudation in the Pleistocene has been established. Under these conditions, the upper layer of the permafrost section is exhibited as a polygenetic feature consisting of alternating epi- and syngenetic horizons of materials (west limb of the Nurminskii arch on the Yamal Peninsula).

Depression type permafrost on low plains is inherent in recent negative structures of the Mesocenozoic cover, in which neither any noticeable advance during the submergence of the region, nor lag during doming, was reflected in the change of the lithofacies - or else they were less contrasting.

It is characteristic of this type of section to be very uniform and clayey in the composition of the deposits. Even the considerable fluctuations in sealevel, which in the arch type section are recorded in a change in the lithofacies and discontinuities of the deposits, are not revealed by the composition in the basin type section. When these deposits have emerged from below sealevel, there is a pattern of diminishing ice content with depth through the section. Increased ice content is characteristic of the upper most horizon of materials measurable in metres. Below this, it decreases uniformly to moisture values until the moisture value brings it to the plastic



limit\*. When there was syngenetic freezing of sediments in basins, in subaerial conditions (periodically submerged river flood plains of rivers, deltas, and swamps), syngenetic permafrost was formed, the thickness of which can be measured in tens of metres (Yana-Indigarka, Kolyma Lowlands). Syngenetic freezing of accumulated sediments was accompanied in polar and subpolar regions of the U.S.S.R. by the development of wedge ice and icy soils.

### THICKNESS OF PERMAFROST

The thickness of permafrost within the permafrost zone is determined by a complex of natural factors caused by the tectonics. These factors affect the permafrost, by way of the heatflow, to its lower limit.

In the regional framework, the most important are those processes taking place in the base, and, in the first instance, at the time of its consolidation (Provodnikov, 1963). The effect of this factor has been best studied in Western Siberia, where the rate of the heat flow increases approximately 1.5 times from the regions of ancient folding to the regions of young folding; this is noticeably reflected in the thickness of the permafrost. The general increase in depth of perennial freezing of materials from west to east (within the permafrost zone) coincides with the increase in age of the base and, consequently, with the decrease in heat flow to the permafrost base (Figure 1). An abnormally great thickness (to 500 m), in the Yenisei area of the plain, is restricted to regions of the oldest folding of the base (Baikal'skaya and Rannelsalairskaya). In the western part of the plain, the thickness of the permafrost rarely exceeds 200 - 300 m, i.e., namely in these regions, the materials of the base have been transformed by younger Hercynian folding. A considerable increase in the density of heat flow towards the permafrost base takes place above the positive structures of high systems. A similar phenomenon, as is known, is associated with the heat anisotropy of stratified materials (D'yakonov, 1954) and with the effect of groundwater (Kudryavtsev, 1954). All of this leads to a reduction of

---

\* Literally "to the limit of being able to be rolled into a string".  
A standard use in soil mechanics in the Soviet Union with regard to clay. (Transl.).

100 - 200 m in the thickness of permafrost (Figure 2); this is borne out in practice by all anticlinal structures of Western Siberia and Yakutia not containing gas deposits (Baulin, 1966; Ostryi, Cherkashin, 1960). In the earth materials above a gas deposit, a low temperature can result from the shielding of the heat flow, and the potential adiabatic expansion of the gas. This is borne out by materials from boreholes in certain gas deposits of Western Siberia.

Figure 1

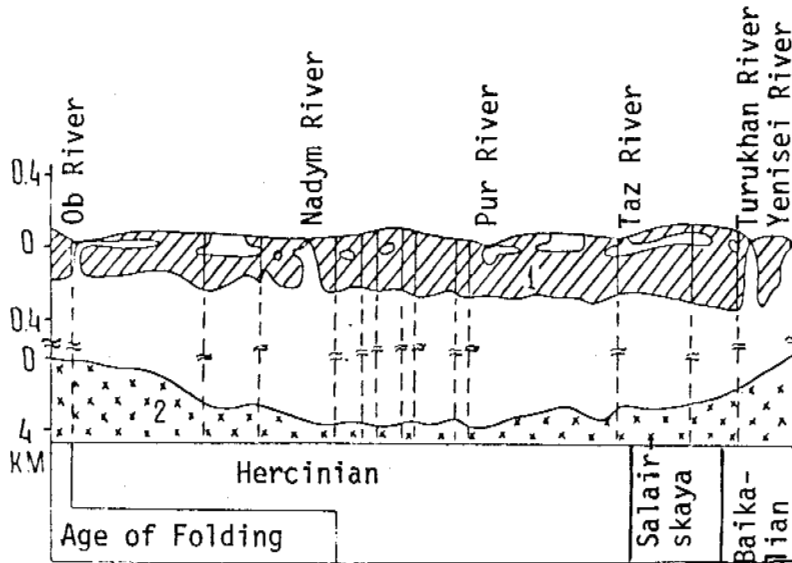

Dependence of thickness of permafrost (1) on the landscape and age of the base (2) West Siberia, 66 - 67<sup>0</sup>s.

Figure 2

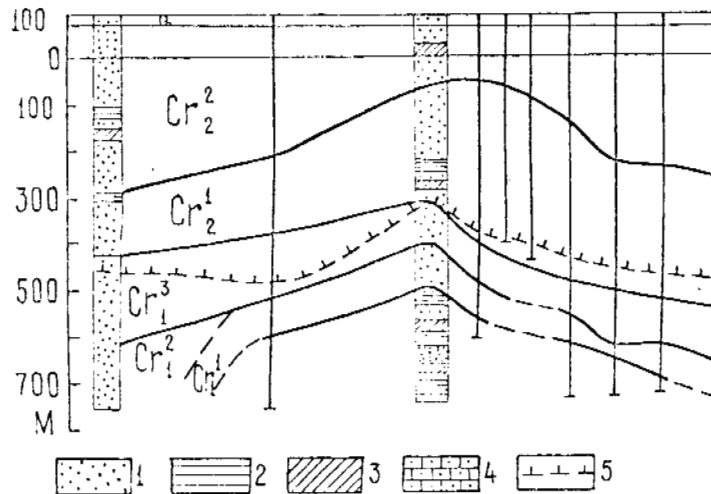

Profile of the Central Vilyui Uplift.  
1 - sand; 2 - clay; 3 - aleurite; 4 - sandstone; 5 - permafrost boundary

## CRYOGENIC PROCESSES AND FROZEN GROUND FEATURES

The tectonics of a region determine the development and spatial localization of the cryogenic processes and frozen ground features, and the direction and intensity of their development.

The main development within the confines of tectonic uplifts is in thermal erosion, small thermokarst forms, epigenetic wedge ice, ice soil and ice veins, and frost mounds (restricted to the drained thermokarst lakes), circle formation, slope processes (solifluction, dells, arable slopes), etc.

In tectonic depressions, the main development is in syngenetic wedge ice, lake thermokarst and frost heave.

Frost fracturing, wedge ice features and polygonal terrain are, to a considerable degree, controlled by the tectonics. The tectonic fissured state of the materials can exert an influence on the formation of a mesh of frost fissures and can determine the direction of the development of polygonal systems, especially in the arches of tectonic uplifts, where tensile stresses develop and make weakened zones. Possible, it is for this very reason that a connection can be seen between the frost fissures and the linear ridge relief on the tectonic uplifts of Western Siberia.

The formation of one type of wedge ice feature or another depends on the tectonic conditions of the region. Thus, thick syngenetic wedge ice is formed only in conditions of accumulation of sediments, i.e., in regions of considerable subsidence. Such are the ice wedges of the lowlands of the Northeast U.S.S.R., and Central Yakutia. Under the same conditions, the rate at which subsidence takes place affects the dimensions of the wedge ice features: the faster the subsidence, the smaller the width of ice wedge and the greater their vertical thickness. In conditions of uplift, it is mainly epigenetic wedge ice features that form; they are mainly wedge shaped, and their vertical thickness usually does not exceed 3 - 5 m and rarely increases to 6 - 8 m. In addition to wedge ice, soil ice and veins also develop; this is connected with the peculiarities of flooding and drainage at the surface and the materials of the seasonally thawed layer.

The tectonic peculiarities of the territory also affect the formation of hummocky permafrost terrain. It is most clearly marked at the surface of the uplifts, having a great effect on the condition of the permafrost. In hummocky terrain, the zones of discontinuous and sporadic permafrost move northwards, insofar as the trench depressions are usually restricted to taliks.

Thawing of ice wedges, and permafrost deformation at the surface of polygonal relic peatlands, also proceed in a different manner in depressions and on uplifts. When there is lowering of terrain, a relatively fast melting of wedge ice and disintegration of peatlands is observed; this is due to the excessive wetting of the surface. On uplifts, the monolithic character of the polygonal peatlands is retained longer, even near the southern boundary.

Heaving. Perennial heaving depends on the composition of the surface deposits and the presence of groundwater that ensures ice formation, i.e., on the factors which are closely connected with the tectonic peculiarities of the territory. In the north of Western Siberia, within the tectonic uplands (Orlince, Samburgskoe), are the renowned frost mounds (hydrolaccoliths), which formed as a result of deep seated discharge water. The height of these mounds reaches 30 m. Analogous heave features have been described in northern Canada, where they comprise a system of mounds 13 - 17 m high, forming two parallel ridges stretching for 50 km. These mounds are "planted" on the line of the tectonic fault and were formed during the freezing of the deep seated waters that discharged along it.

Perennial heaving during freezing of variegated, marine, Pleistocene deposits on positive structures in Western Siberia led to the formation of mounds of lesser dimensions (to 10 m) without an ice core. They have been examined in detail on the Urengoiskoe, the Pur-Peiskoe and other uplifts.

To heave formations developed exclusively on positive structures belong the linear ridge landscape (Bol'shekhetskoe, Samburgskoe, Tab-Yakhinskoe and other uplifts in West Siberia). It is a system of ridges and depressions, regularly oriented in the direction of the basic tectonic disturbance.

In tectonic depressions, perennial frost mounds have a more limited distribution. Their growth is brought about by ice formation in clayey deposits of the flood plain facies of alluvium or lake-swamp deposits. These are thicker in territories that underwent submergence during the Pleistocene and the Holocene. This type of mound has been studied in West Siberia (Yaginetzkaya and Nadymkaya depressions) and in the European part of the U.S.S.R.

Thermokarst. The high ice content in the upper permafrost horizon, and also the low degree of dissection of the surface in tectonic depressions, furthers the development of thermokarst lakes within them. Thus, on the Nadym-Pur interfluvium of Western Siberia, lakes can occupy 50% of the surface, while in the arch region of the uplifts, it decreases by 2.5 to 10% (Lastochkin, 1969).

At the same time, deep thermokarst lakes which formed as a result of the melting of thick ice lenses of injected origin, are encountered within the confines of uplifts.

Uplifts characteristically have oriented lakes and basins, as described for the maritime plains (Stremyakov, 1963; Velikotskii, 1972) and Western Siberia, where they are found in the depressions (Andreev, 1960). The orientation of lakes is caused by their confinement to lines of tectonic disturbances.

On uplifts, thermokarst combines with the processes of thermal erosion; this leads to the development of an erosional network of gullies, to the dissection of the surface, to the lowering of lakes and to the formation of khasyrei (West Siberia) and alas (East Siberia). Alas and khasyrei are widely distributed even within the confines of uplifts, but the percentage is much higher in relation to the general frequency of lakes on uplifts.

Reformation of permafrost, which is taking place at present on the western region of the permafrost zone, and which, on the whole, is caused by the cooling of the climate that began in the Fifties, is also controlled by the tectonic regime of the territory. In tectonic depressions of the taiga

zone of Western Siberia, the most intensive reformation of permafrost is taking place in the relatively dry areas, the gradual submergence of which leads to the accumulation of moss cover. An increase in the amount of water in the damp areas, under these conditions, can give rise to another effect, i.e., it can lead to the thawing of existing permafrost. On the tectonic uplifts of this zone, reformation of permafrost is characteristic for the extreme areas of bog which are in the process of draining and which border on the forest, where there is intense growth of mosses. This type of phenomenon is observed on the Vyangpurovskoe uplift of the Siberian Uvalas.

#### REFERENCES

- ANDREEV Yu.F. Mnogoletnyaya merzlota i ee znachenie dlya poiskov struktur na severe Zapadnoi Sibiri. (Permafrost and its importance in the investigation of textures in the north of Western Siberia). In the book: Ocherki po geologii severa Zapadno-Sibirskoi nizmennosti (Studies on the geology of the north of the West Siberian Plain). Trudy VNIGRI, No. 158, L., pp. 191-218, 1960.
- BAULIN V.V. Moshchnost' merzlykh tolshch kak odin iz pokazatelie tektonicheskogo stroeniya raiona. (Thickness of permafrost as an indicator of the tectonic structure of the region). Geologiya i geofizika, No. 1, pp. 53-61, 1966.
- BAULIN V.V. Vliyanie tektoniki na mnogoletnomerzlye protsessy. (The influence of tectonics on permafrost processes). - Izv. AN SSSR Ser. Geogr. No. 6, pp. 75-79, 1970.
- BAULIN V.V., SHUTKIN A.E. and DANILOVA N.S. Novye dannye o stroenii mnogoletnemerzlykh porod v nizov'yakh r. Vilyui. (New data on the structure of permafrost in the lower reaches of the Vilyui River). Izv. AN SSSR, Ser. Geogr. No. 1, pp. 75-82, 1970.
- BELOPUKHOVA E.B. Osobennosti mnogoletnego pucheniya v predelakh tektonicheskikh podnyatii na severe Zapadnoi Sibiri. (Peculiarities of perennial frost heave within the limits of the tectonic uplifts in the north of Western Siberia). Trudy PNIIS, Vol. XI, M., pp. 127-131, 1971.
- BELOPUKHOVA E.B. and DANILOVA N.S. Osobennosti formirovaniya mnogoletnemerzlykh porod doliny rek Pravoi Khetty i Nadyma. (Peculiarities in the formation of permafrost in the valleys of the Pravaya Khetta and Nadym Rivers). Trudy PNIIS, No. 29, M., Stroizdat, pp. 103-110, 1974.

- VELIKOTSKII M.A. Svyaz' termokarstovykh protsessov s neostrukturami i intensivnost'yu noveishikh tektonicheskikh dvizhenii na territorii Yano-Omoloiiskogo mezhdurech'ya. (Connection of thermokarst processes with the neostructures and intensity of recent tectonic movements in the territory of the Yana-Omoloi Interfluve). Problemy kriolitologii (Problems of Cryolithology), No. II, Izd-vo MGU, pp. 54-64, 1972.
- VELIKOTSKII M.A. O roli tektonicheskoi treshchinovatosti v razvitii termokarsta na severe Yano-Omoloiiskogo mezhdurech'ya. (The role of the tectonic fissured state in the north of the Yana-Omoloi interfluve), Problemy kriolitologii (Problems of Cryolithology), No. IV. Izd-vo MGU, pp. 244-251, 1974.
- Geologicheskoe stroenie i prognoz neftegazonosnosti severa Zapadnoi Sibiri. (Geological structure and the prediction of the presence of oil and gas in the north of Western Siberia). Trudy VNIGRI, no. 263, L. "Nedra", 246 pages, 1968.
- GERASIMOV I.P. Osnovnye printsipy i zadachi morfostrukturnogo analiza. (Basic principles and problems of morphostructural analysis), In the book: Primenenie geomorfologicheskikh metodov v strukturno-geologicheskikh issledovaniyakh. (Implementation of geomorphological structural methods in structural geology research), M., "Nedra" 1970.
- D'YAKONOV D.I. Geotermya v neftyanoi geologii. (Geothermy in petroleum geology). M., Gostoptekhizdat, 277 pages, 1958.
- Karta sovremennykh vertikal'nykh dvizhenii zemnoi kory Vostochnoi Evropy. (Map of contemporary vertical movements of the earth's crust in Eastern Europe), Scale 1 : 2,500,000. Editor-in-chief - Yu.A. Meshcheryakov, 1973.
- KUDRYAVTSEV V.A. Temperatura verkhnykh gorizontov vechnomerzloi tolshchi v predelakh SSSR. (Temperature of the upper horizons of permafrost in the U.S.S.R.). M., Izd-vo AN SSSR, 184 pages, 1954.
- LASTOCHKIN A.N. Rol'neotektoniki v raspredelenii i morfologii ozer severa Zapadno-Sibirskoi ravniny. (Role of neotectonics in the distribution and morphology of the lakes of the West Siberia Plain). Izv AN SSSR, Ser. geogr. No. 5, pp. 79-86, 1969.
- MATVEEVA T.A. and PERUGIN N.N. Nekotorye osobennosti stratifikatsii neogenovykh (miotsen-antropogenovykh) otlozhenii severa Zapadnoi Sibiri. (Some peculiarities of the stratification of neogenic (Miocene-Quaternary) deposits of the north of Western Siberia). Trudy VNIGRI, No. 293, "Nedra", pp. 57-74, 1971.

- ORLOV V.I. Analiz dinamiki prirodnykh uslovii i resursov. (Analysis of the dynamics of environmental conditions and resources). M., "Nauka", 275 pages, 1975.
- OSTRY G.B. and CHERKASHIN A.F. Povedenie nizhneigranitsy vechnomerzlykh porod kak odin iz kriteriev pri poiskakh struktur na severo-vostoke Zapadno-Sibirskoi nizmennosti. (Behaviour of the lower permafrost boundary as one of the criteria during research into the texture on the Northeast of the West Siberian Lowland). "geologiya i geofizika" No. 10, pp. 62-68, 1960.
- POPOV A.I. Merzlotnye yavleniya v zemnoi kore (kriolitologiya). (Permafrost phenomena in the earth's crust (cryolithology)). Izd-vo MGU, 304 pages, 1967.
- POPOV I.V. Inzhenernaya geologiya SSSR. (Engineering geology of the U.S.S.R.). Pt. 1. Izd-vo MGU, 178 pages, 1961.
- PROVODNIKOV D.Ya. Karta tektonicheskogo raionirovaniya Zapadno-Sibirskoi plity. (Map of tectonic regionalization of the Western Siberian platform). Novosibirsk, Izd-vo AN SSSR, 1963.
- STREMYAKOV A.Ya. K voprosy o proiskhozhdenii orientirovannykh ozer. (Problem of the origin of oriented lakes). In the book: Mnogoletnemerzlye gornye porody razlichnykh raionov SSSR. (Permafrost in various regions of the U.S.S.R.). M., Izd-vo AN SSSR, pp. 75-107, 1963.
- CHOCHIA N.G. Lokal'nye (struktyuroobrazuyushchie) neotektonicheskie dvizheniya severa nizmennosti i ikh vyrazhennost' v rel'efe. (Local (structure-forming) neotectonic movements in the north of the lowland and their manifestation in the landscape). Trudy VNIGRI, No. 263, L., "Nedra", pp. 166-173, 1968.





CRYOLITHOGENESIS AS AN INDEPENDENT HYDROTHERMAL TYPE  
OF SEDIMENTARY PROCESS

Sh.Sh. Gasanov

Pacific Institute of Geography, Vladivostok, U.S.S.R.

The theory of cryolithogenesis is a promising comprehensive trend in permafrost studies allowing us to elucidate more thoroughly the structural and textural patterns of frozen earth materials, to assess their properties and to work out scientifically substantiated forecasts of their short- and long-term development.

The position of cryolithogenesis in the system of physico-geographical variants of soil and rock formation on Earth is delineated by hydrothermal factors predetermining and modifying geoenergy and stress levels of the total conjunction of simple sedimentary and diagenetic processes and mineral transformations (Popov, 1967, 1976; Shilo, 1971; Gasanov, 1973, 1976; Danilov, 1973; Katasonov, 1973, etc.).

As was demonstrated earlier, cryolithogenesis as a zonal hydro-thermotype of the sedimentary process develops in areas with a positive balance of the atmospheric moisture and with negative temperatures at the base of the active layer; furthermore, the outer boundary of the cryogenic zone coincides approximately with the boundary of the phreatic belt in the humid zone (Gasanov, 1976).

In nature humid rock-forming processes are replaced by cryogenic processes gradually and the level of stress, lithogenetic effect and diversity of the latter increases in the direction of high latitudes as the air temperatures drop. The extent of the physico-chemical alteration of the

matter involved in lithogenesis is a function of the length of time during which it is subjected to the given dynamic and hydrothermal conditions, a circumstance determined in its turn by the potential energy of the materials transported into the zone of hypergenesis. This energy depends on the altitude, at which the material in question is found in the given terrain, on the latitude of the locality and on the distance from the catchment basin.

Unparalleled distinctive physico-chemical lithogenetic processes occur within the cryogenic zone during the main stages of sedimentation (weathering, migration, accumulation and diagenesis), as a result of which there develop typomorphic parageneses of earth materials differing radically in all the characteristics pertaining to their composition, structure and texture, from the products of lithogenesis in other zones.

The physical and mineralogical stabilization of the reactive components of the newly deposited sediment (i.e., mineral matter, water, solutions and gases) and the transformation of the sediment into a sedimentary formation occurs in the cryogenic zone below the base of the seasonally thawing layer (SThL) under thermodynamic conditions which are not characteristic of other zones. With respect to their lithogenetic effect the sum total of the processes occurring below the SThL may be referred to the category of diagenetic processes (Popov, 1967; Danilov, 1973; Katasonov, 1973), with the foot of the SThL acting as the phreatic surface of the groundwater outside the cryogenic zone, which forms the boundary between two media differing in regimen and physico-chemical state.

As is well known, the main distinctive features in the composition, structure and texture of the products of cryogenic diagenesis (both subaerial and subaqueous) are determined by the temporal relationship between the processes of accumulation and those of long-term freezing. Corresponding parageneses of frozen rocks are established in conformity with the above. The parageneses are amalgamated into types and subtypes, the systematic position of which may be represented in the following form (a point on which most cryolithologists agree).

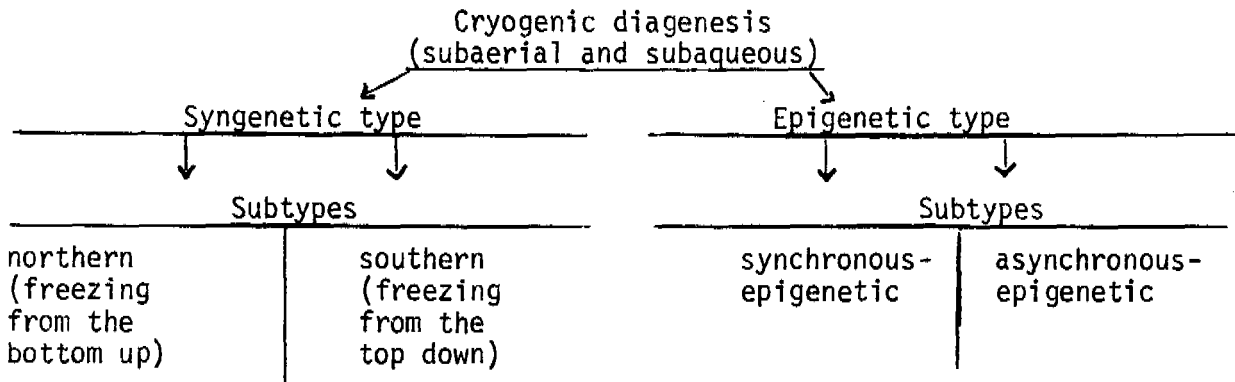

The specific aspects of physical and chemico-mineralogical transformations in the cryogenic zone at the stage of the mobilization matter are described in I.A. Tyutyunov's works (1960). The most effective processes are those of the physico-chemical weathering constituting a succession of several interrelated elementary processes, as is illustrated in the following diagram:

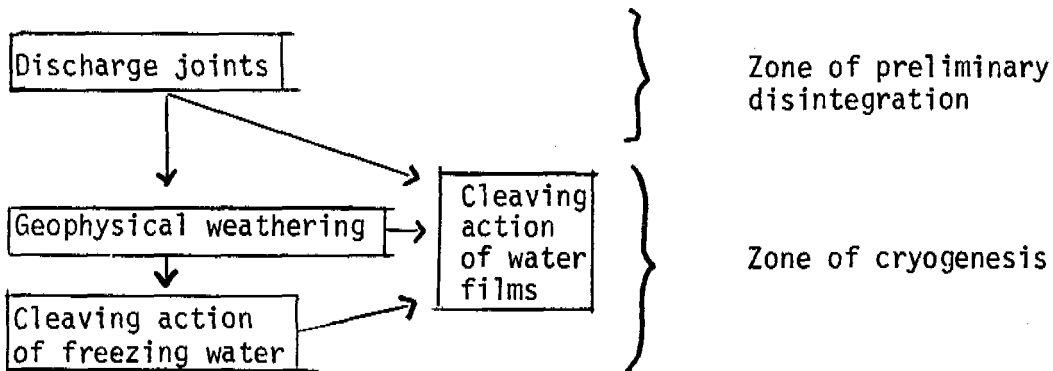

As a result of this, a fraction of the internal energy of primary silicates and aluminosilicates is transferred to the surface of clastic materials thus increasing their physico-chemical activity and stimulating the development of the intricate cryogenetic complex of processes. Cryogenesis, which commonly develops in neutral, weakly alkaline or weakly acidic media, is accompanied by leaching, as well as by vertical redistribution and removal in a definite sequence of the mobile products of decay (Tyutyunov, 1960). At the same time there takes place a synthesis of low-temperature minerals with a predominantly hydromica-montmorillonite composition (Konishchev, 1973; Uskov, 1973). During the weathering, the processes of ice formation fulfill a dual function being both an effective weathering agent and a component of the resultant earth materials, where they act as an authigenic mineral. At

the initial state of the mobilization of matter, the ice forming in thermophysical weathering joints causes cleaving which exceeds the resistance of earth materials to rupture; furthermore, the formation and melting of ice in the interstitial space ensure the displacement of the resultant fragments and their shift in the horizontal direction.

In the event of complete colmatage of the pore space with products of physico-chemical weathering, the ice formation in the seasonally thawing layer acts in yet another capacity contributing to the separation of the polydispersed system with evacuation of coarser fractions to the surface. As this type of sorting progresses, while weathering of the material transported to the surface continues, the lower layers of the profile invariably change to permafrost under conditions of reduced washout. Moreover, the ice (segregated and cement ice), as well as crystallohydrates become then incorporated into the sequence of frozen earth materials as new typomorphic mineral formations.

As a result of the joint effect of the processes examined and their development in environments with reduced washout, there forms in flat water-dividing areas of the cryogenic zone a distinctly differentiated weathering-crust profile of the cryogenic type (Gasnov, 1973). Taking into account the specific nature of the weathering processes (cryogenesis) and the distinctive composition and structure of their products, this type of weathering crust may be referred to as cryogenic-siallitic.

During the slope stage of cryolithogenesis the migration of the material mobilized by weathering is realized under the effect of a series of successive typomorphic physical processes based on periodic formation and melting of ice. We can distinguish several belts on the slopes of a complete profile of the cryogenic zone. These belts differ in the dominant of the cryogenic lithogenetic process and are controlled by the steepness of the slope and by the composition of mobile weathering products.

In the apical portion of the slope the movement of the rock-block material is effected through separation and expulsion of frozen water fragments in micro-lows of the slope and in the pore space of the parts of

mobile material found near the bottom. An active fragment sets in motion the fragments surrounding it in any direction of the upper half-space with the resultant oriented down the slope under the effect of gravity. The belt of rock streams extensively developed in the cryogenic zone, arises in this manner.

Continuing physical and physico-chemical weathering processes pave the way for other forms of denudation, first of all for subsurface washout of sand and landwaste by thaw and rain water. The products of the washdown gradually fill the pore space and often form debris cones, which may coalesce here and there, along the periphery of the belt of rock-streams.

Below the second belt there occurs separation of the polydispersed medium once the interstitial space has been filled with silt, in which ice formation under the effect of the seasonal freezing and thawing is possible. The separation is accompanied by the evacuation to the surface of coarsely fragmentary material (residual freezing out). The magnitude of the freezing out of fragment  $H$  in the course of the corresponding freezing-thawing cycles  $n$  is determined by the vertical area of contact of the fragment with the freezing soil or rock  $S_h$  on the one hand and by the mean magnitude of heave  $\Delta h$  on the other:

$$H = S_h f (\Delta \bar{h}) n$$

As soon as a definite amount of fine-grained fractions accumulates in the cryogenic talus and the coarsely fragmentary material becomes uncohesive because of separation, the washdown of the talus gives way to solifluction, a qualitatively new process playing a major part in morpholithogenesis of the slopes in the cryogenic zone. As a result of the work carried out by L.A. Zhigarev, V.S. Savel'eva and other researchers, it has been established that solifluction is a viscous-plastic laminar flowage of thawing or freezing humid dispersed earth materials. The epures of their velocity and tangential stresses are roughly described by the Shvedov-Bingham's rheological stability law for the case of tangential

stresses  $r$  exceeding the long-term shearing strength of the soil or rock by  $r_{L-t}$ \*

$$r = \gamma h \sin \phi; \quad r = r_{L-t} + \eta \frac{dV}{dZ},$$

where  $\gamma$  is the volume weight of the earth material;  $h$  is the depth from the surface;  $\eta$  stands for viscosity of unfrozen earth materials;  $\frac{dV}{dZ}$  is the vertical gradient of velocity; and  $\phi$  is the angle of the slope.

We may thus distinguish four lithodynamic belts with mobile and diffuse boundaries on the slopes of the complete profile in the cryogenic zone. In tectonically stable regions with a fairly smooth relief and stable climatic conditions the belts examined gradually move up the slope and become superimposed one upon another.

In an environment marked by the ascending development of cryogenic lithodynamic belts, various types of subterranean ice change to the fossil state as new diagenetic formations. Down the slope the processes of underground ice formation become increasingly more complex with formation of progressively larger agglomerates in the following sequence: cement-ice, segregated ice, wedge ice. The above complex of different types of ice formation is characteristic of the slopes in complete profiles and in the event of the lower belts becoming reduced as a result of intensified denudation (washout) processes, the concurrent types of ice formation drop out.

In the areas, where the structures and textures of the cryosphere are of the continental type, fluvial processes play the leading part in the evacuation of the material transported to the foot of the slopes, as well as in its mechanical and facies differentiation. The formation of alluvium in the cryogenic zone is accompanied by a number of typomorphic, concurrent or overprint cryogenic processes. These processes have a marked lithogenetic effect particularly clearly perceptible during the "constrative" \*\* phase.

---

\* L-t. = long-term. (Transl.).

\*\* Unable to find the meaning of the term "constrative". (Transl.).

Because of this, as well as due to cryogenic diagenesis, the products of the fluvial accumulation acquire distinctive features of composition, texture and structure, which are not characteristic of other zones. Their specific nature is precisely the evidence, on the basis of which A.M. Katasonov, A.I. Popov and Yu.A. Lavrushin set apart alluvium as an independent geographical variant.

Alluvium from mountain streams of the cryogenic zone is altered but slightly and reveals all the distinctive features of composition, structure, texture and facies ratio characteristics of alluvium from the humid zone (Shantser, 1966). The distinctive dynamics of the processes shaping river beds, as well as of erosion and accumulation processes in the mountain belt result in a significant preponderance of beds exhibiting the synchronous-epigenetic type of freezing. Because of this and in conformity with the composition of the predominant earth materials, the ice formed here is mainly of the ice-cement type. Ice-rich sediments with streaky cryostructures are therefore found at localized sites in the rock-sequences of terraces and flood-plains of mountain streams in the form of lenses of a small extent. In conformity with the distinctive nature of cryolithological structures and textures described above, thermokarst processes have a limited development in alluvium from the mountains and play a minor role in the morpholithogenesis of the valleys. The alluvial deposits examined thus form one single inter-related complex with deposits of the slope series and with those of mountain or valley glaciers. This complex can probably be treated as having the rank of a cryolithological formation from mountainous countries.

Alluvium of the rivers from the plains in the cryogenic zone in an environment, where erosion and accumulation are perceptibly affected by cryogenic factors at every stage of the hydrographic system.

Fluvial deposits building river beds or found in suspended state, are largely silty in composition and represent the final product of weathering (Konishchev, 1973). Because of this, as well as due to the continuous exchange between the fluvial drift (building the river bed or suspended) on the one hand and deposits from river banks on the other, the



differentiation of the principal alluvial facies by grain size is relatively small. The differences in the structures and textures of the sediment are more pronounced.

The most clearly perceptible signs of the effect of cryogenic factors on erosion and accumulation have been recorded in the flood-plain horizon. The growth of syngenetic wedge ice (WI) is of primary importance among these factors. Wedge ice alters the morphology of the fluvial plain, its hydrological regimen and sedimentation dynamics, as well as the composition and structure of the sediments.

As is well known, the formation of WI is accompanied by the development on the surface of a distinct relief with low-centre polygons. As a result of this the hydrological regimen of the flood plain changes: flood water does not invade it frontally in a continuous layer, but slowly seeps through the vegetation and fills polygonal depressions, whereupon only the ridges of the polygons project partly or completely above the water. The presence of polygons in the relief markedly increases the degree of surface roughness. Direct erosion of the flood-plain surface commonly observed in the temperature belt, therefore does not occur here. Flood waters do not vacate the fluvial plain with the decline of the flood in the stream channel, as is the case in the humid zone, but remain there for a lengthy period of time, up until the winter. Suspended matter becomes deposited in still water, as a result of which flood-plain sediments of the cryogenic zone are devoid of the flowing-water type of bedding. Moreover, with respect to their environments of deposition, texture and structure, these sediments are closer to the lacustrine than to the flood-plain type. In the continental part of the permafrost region, in the event of a certain climatic structure prevailing, not only all of the suspended and colloidal matter, but also the salts dissolved in the water precipitate, as a result of which the salt content in the sediments of the present-day flood-plain horizon increases. Under conditions of the shortage of atmospheric moisture during the summer leading to the evaporation of water from the depressions of the polygons, the salinity of flood-plain sediments is determined according to (Gasarov, 1976)

$$S = \frac{S_B h}{\gamma \bar{m}}$$

where  $S$  is the salt content of the earth materials;  $S_B$  stands for the salinity of the flood water;  $h$  is the height of the evaporating water column;  $\gamma$  is the volume weight of the soil and  $\bar{m}$  stands for the mean annual thickness of the alluviation.

Wedge ice (WI) is the most characteristic structural and textural feature of alluvium in rivers from the plains. Under syngenetic conditions of growth WI attains significant dimensions.

In the areas governed by geothermal conditions, the morphology, texture and structure of WI are (as has been demonstrated by B.N. Dostovalov) closely related to the sedimentation dynamics. Taking into account this fact and other variables, we can distinguish three theoretically possible growth patterns of WI, which determine the main parameters of their mode of occurrence.

1.  $L_{\max} = \alpha$  at  $m \geq h - \xi$ ,
2.  $L_{\max} = \frac{h - \xi}{2m}$  at  $m < h - \xi$ ,
3.  $L_{\max} = \frac{h - \xi}{2m}$  at  $m \rightarrow 0$ ,

where  $L_{\max}$  is the maximum width of an ice vein,  $\alpha$  is the width of a rudimentary year-old vein,  $m$  is the rate of sedimentation,  $h$  stands for the depth of penetration of an open frost fissure, and  $\xi$  is the depth of seasonal thaw.

The first pattern is possible only theoretically, since steady accumulation of sediments with the thickness specified as an unrealistic proposition. The second pattern reflects the growth of syngenetic WI, and the third pattern - that of epigenetic WI.

In conformity with the condition of the second pattern at  $m \ll \alpha$  wedge ice should expand in width to several tens of metres, and according to the conditions of the third pattern - to infinity, i.e., up until it coalesces with the next parallel vein. However, this does not occur, since

the growth of WI in width is limited by the decrease in the width of the frost fissure with the growth of the ice vein in conformity with the well-known ratio of the thermal expansion coefficients of ice and frozen ground (Grechishchev, 1970).

The syngenetic WI developing under the flood-plain regime (pattern 2), may evolve according to three main patterns, as depending on the correlation between  $m$  and  $\alpha$ :

1.  $L_{\max} < 0.5 (h - \xi)$  at  $m > \alpha$
2.  $L_{\max} = 0.5 (h - \xi)$  at  $m = \alpha$
3.  $L_{\max} > 0.5 (h - \xi)$  at  $m < \alpha$

The syngenetic WI formed according to the first two patterns, fails to attain its maximum size because the reserve of the thermoelastic deformation of the block is utilized here incompletely: due to the high rates of sedimentation and corresponding displacement of the permafrost roof, the number of cycles of ice formation at a fixed level falls short of the maximum figure. Reduction of the number of cycles at each level of ice formation is compounded by the fact that the rudimentary year-old vein decreases in length with expansion of the ice wedge in width. The WI growing under the flood-plain conditions according to the first two patterns has a small width ( $L_{\max} \leq 0.5 (h - \xi)$ ), straight lateral contacts, and minimal flexural strain in the cores of the polygons.

Expansion of WI in width in conformity with the third variant outstrips the rate of the upward aggradation of permafrost. Consequently at a certain stage, having exhausted the reserve of thermoelasticity of the block, the ice vein attains its maximum width and ceases to grow. In an environment with sedimentation continuing steadily in the flood plain and a corresponding rise of the permafrost roof, the magnitude of thermoelastic strain of the block increases (conversion of a two-component system to a single-component system with maximum values of the thermal strain coefficient) and the ice vein starts growing once again. As a result of

multiple recurrences of such cycles there arises a system of "limit"\* ice veins which are inserted inside one another and have flexuose or scalariform lateral contacts at the level of each cycle of renewed growth. A vein of this kind attains the maximum width all along its height ( $L_{\max} > 0.5 (h - \xi)$ ). The cyclic growth pattern of WI has also been recorded in the structure and texture of polygon cores. These cores are represented by series of steeply bent or horizontal ice-soil layers. Each series corresponding to a full cycle is associated with a portion of the "limit" vein bounded along the vertical by two neighbouring contiguous shoulderings, and reflects the gradual replacement of the conditions prevailing in a low centered polygon filled with water, by those of a flat polygon, as the growth of the relevant portion of the "limit" vein discontinues.

As is well known, the growth of WI is accompanied by the evacuation to the foot of the SThL of the enclosing earth material equal in volume to the newly formed ice. In terms of the dynamic effect this type of ice formation is therefore equivalent to the accumulation on the flood-plain surface of the yearly accretion of fluvial drift of a corresponding thickness. In conformity with the rule dictating that sedimentation and WI formation must be in a state of equilibrium, the rates of growth of the SThL vary in the transverse section of the flood-plain. In the inner flood-plain\*\* the veins grow annually, at maximum rates and to maximum dimensions, whereas towards the stream channel syngenetic WI gradually decreases in size because of the more intensive alluviation. The inner flood plain in the cryogenic zone thus aggrades at the same rate as the area adjoining the waterchannel or even faster, as a result of which the transverse section of the flood-plain acquires a gradient oriented towards the river-bed rather than towards its rear boundary, as is the case in the humid zone. Syngenetic aggradation of frozen flood-plain sediments with the parallel growth of syngenetic WI may continue for a lengthy period of time without being interrupted by thermokarst or by lateral drift of the stream channel. As has been demonstrated by V.L. Sukhodrovskii, the latter is restricted to a narrow belt of meandering with possible formation of a mass

---

\* i.e. with the maximum possible width. (Transl.).

---

\*\* May refer to the river bed itself. (Transl.).

of superposed flood-plains. The ice veins overlain by a migrating watercourse, cannot thaw out completely, because on the territory of a plain thermal settling of the stream-channel floor would lead to a reduction in the gradient or (in the event of WI having a significant thickness) may even result in formation of reversed slopes (gradients). Therefore, should a water channel find itself migrating above syngenetic ice veins, their partial thawing from the top will invariably be accompanied by intensified accretion of stream-channel alluvium, which would first limit, then arrest the degradation of permafrost. The hypothesis postulating that WI invariably thaws out into the "constrative" phase as a result of the intensive migration of the stream channel over the valley, thus contradicts the dynamics of watercourse processes. This is one of the main reasons for the limited content of stream-channel facies in the profiles of "constrative" alluvium from the cryogenic zone versus the alluvium found in the temperature zone.

Following the establishment on the surface of high flood-plain conditions, thereupon of the terrace regime, overprint processes of lacustrine thermokarst begin intensively developing in wedge ice under the effect of increased surface humidification, and wedge ice grows to a considerable size by following the epigenetic growth pattern 3. In contrast to the conditions prevailing underneath a river bed, sublacustrine thawing may penetrate to considerable depths, since the restraining condition mentioned earlier with reference to rivers, does not apply here.

In the event of thermokarst lakes being drained or drying out, the taliks underlying the lakes freeze in a synchronous-epigenetic manner. Under certain lithological and hydrogeological conditions this induces redistribution of free water under the effect of pressure with subsequent localization and freezing of that water in conformity with the laws governing the formation of injection ice. In the system of processes representing cryogenic diagenesis, injection is the final stage of ice formation giving rise to the largest concentrations of ground ice.

In environments of this kind ice forms in several stages. The formation of ice is triggered off by the draining of the lake, whereupon one or several sedimentary lakes remain at the bottom of the young alas. The

second stage is associated with freezing of the alas overburden during the first winter. The freezing is accompanied by formation of segregated ice and by corresponding heaving of the surface outside the residual lake, beneath which there remain unfrozen earth materials. During the freezing of the basal layers of the overburden interstitial waters of the underlying sand may also become involved in the formation of segregated ice to the level of the maximum capillary rise of water, i.e., to the depth of the first few tens of centimetres. Once the water content attains the level of capillary rupture, the hydraulic unity of the water column becomes disturbed and the process discontinues. In the balance of ice formation within the overburden this category of water is therefore of secondary importance even with regard to the maximum magnitudes involved.

The subsequent freezing and the inclusion into this process of the coarse-grained water-saturated soil materials from the talik mark the beginning of the third developmental stage in the system. This stage is accompanied by water being expelled from the freezing front in amounts exceeding the volume of the interstitial space in conformity with the formula (Tsytovich, 1973)

$$V = \beta n S \frac{\Delta h}{\Delta t}$$

where  $V$  is the volume of the water expelled,  $\beta$  is the volume expansion coefficient of water during freezing,  $n$  stands for the porosity,  $S$  is the freezing area and  $\Delta h$  is the thickness of the layer freezing during the time interval  $\Delta t$ .

In these circumstances the kinetic energy of heaving will be attenuated by the resistance of the most markedly weakened part in the roof of the system underlying the residual lakes. Consequently, the maximum pressure in the roof of the water-bearing layer will be equal to the natural pressure of the layer undergoing deformation, provided we take into account the resistance to shear along its rear glide planes:

$$p = (\gamma_w h_w + \gamma_g h_g + r_s) - \gamma_w H$$

where  $p$  is the pressure in the closed system;  $\gamma_w$  and  $\gamma_g$  stand for the volume weight of water in the residual lake and of the underlying earth materials (ground), respectively;  $h_w$  and  $h_g$  stand for the thickness of the water and earth material layers, respectively;  $r_s$  is the resistance of the layer undergoing deformation to shear along its gliding perimeter; and  $H$  is the piezometric level (surface) of water in the closed system. Under conditions of continuing freezing of the system, the equilibrium at the roof of the aquifer will become disturbed inducing discharge, hydrostatic suspension and heaving of the roof deformed until the reestablishment of the state of equilibrium. In the event of the talik becoming completely frozen, the volume of the frost mound  $V_h$  will be

$$V_h = \beta V$$

Starting at some initial point in the freezing of the talik, the system begins to function according to the same principle as a hydraulic press; therefore, the smaller the diameter of the residual lake relative to that of the alas, the greater the resistance of the lake floor to deformation. This suggests that differential heaving is possible only at a definite diameter of the residual lake. If it is below a certain critical size, there will either form a flat ice layer, or interpermafrost pressure water will persist beneath the frozen crust. In the presence at the bottom of the alas of several residual lakes with different diameters, all larger than the critical size, the site, at which kinetic energy of pressure water becomes attenuated, will gradually shift from the large to the small residual lakes as the hydrochemical situation changes. The maximum heaving will occur beneath the few large, though shallow residual lakes found in the alas, where all the pressed out water concentrates. The lake may increase in diameter as a result of the residual lake water retreating (in the form of a ring or half-ring) from the heaving site, and the alas deposits frozen earlier may partly thaw out and grow warmer underneath that water. In the event of an asymmetrical retreat of the lake, the heaving plane tilts in such a manner that its high face is oriented towards the deeper part of the lake.

Heaving deformations in the lake begin at the weakest point of the bottom rather than all over the lake floor, which is due to the uneven bottom

topography and unequal thickness of the overburden. Up until a certain level the heaving occurs exclusively on account of the infiltration of water into the weakened zone. Thereupon (after the summit of the mound emerges above the water level) the infiltrated water begins to freeze causing the mound to increase in volume accordingly and producing additional hydrostatic pressure within the system. As the ice core of heaving grows, the radius of the freezing front increases, as a result of which the ice core acquires a lenticular shape. Migration of water from the residual lake underneath the mound and the ice core is precluded under these circumstances by the filtration pressure head in the unfrozen part of the closed system and by the corresponding temperature stratification in the frozen zone.

Viewed from positions of cryogenic diagenesis, the major impact of injected ice formation in alases lies in assembling the initially disseminated and disjointed ice into a larger homogeneous mass with an appropriate morphological expression of that block on the surface.

The final event in ice formation at the conclusive stage of continental lithogenesis in the cryogenic zone is repeated injection, the products of which are known under the name of "ice sheets" or "massive ice". Views on the mechanism governing their formation vary. These views were analyzed in B.I. Vtyurin's work (1975).

Judging from the sum total of the evidence available, the ice sheets discussed correspond most fully, in our opinion, to the mechanism of injection.

The position of repeatedly injected ice (RII) in the general pattern of cryogenic lithogenesis is quite clear and differs from that of the injected ice proper discussed earlier. Repeatedly injected ice forms under conditions of synchronous-epigenetic freezing of lithologically non-homogeneous media over large areas vacated by sea water under the regressive regime, or of ice sheets in foothills. No repeatedly injected ice forms in the territories, where conditions of the syngenetic formation of loose overburden prevail for a long time. This is the point, where



repeatedly injected ice differs radically from injected ice proper, and which may serve as a key to predicting the main distribution patterns of the former.

Loose multilayered deposits from such territories contain different categories of underground waters, including gravitational water. In porous sandy or sandy-pebbly media, within one single hydraulic system, free water steadily moves with laminar flow (Darcy's law). The total energy at any point in the fluid in the cross-sectional areas of the flow, which are being compared, is defined according to the conservation of energy or constant head principle (Bernoulli's law) as the sum of the elevation head, pressure head and velocity head

$$Z_1 + \frac{P_1}{\gamma} + \frac{V_1^2}{2g} = Z_2 + \frac{P_2}{\gamma} + \frac{V_2^2}{2g} + h_{1-2}$$

where  $Z_1$  and  $Z_2$  represent the elevation of the points in the flow above the level selected for comparison;  $P_1$ ,  $P_2$  and  $V_1$ ,  $V_2$  are hydrostatic pressures and velocities of motion, respectively, in the cross-sectional areas compared;  $\gamma$  is the volume weight of water;  $g$  is the acceleration of gravity; and  $h_{1-2}$  is the loss of head in the cross-sectional areas compared.

Darcy's and Bernoulli's laws, considered in conjunction with one another, explain the principal mechanism governing the movements of groundwater in an anisotropic medium, as well as the relationship between the morphological conditions of the flow on the one hand, the hydrostatic head, velocity of the flow, and hydraulic gradient on the other.

In the event of synchronous-epigenetic freezing of the earth materials containing such waters, there occur directed changes in the boundary conditions and the motion of the flow becomes unstable. The flow regimen becomes disturbed as a result of permafrost barriers arising in filtration paths and blocking the flow partly or completely. Emergence of a permafrost barrier leads to a partial or complete attenuation of kinetic energy and to its conversion to potential energy in the form of additional backwater  $\Delta h$  and corresponding heaving of the surface above the obstacle, which is equal, according to Bernoulli's equation (Utkin, 1973), to

$$\Delta h = \frac{v_1^2 + v_2^2}{2g}$$

Since the water-bearing stratum within one single hydraulic system covers a fairly large area, the backwater may spread over tens or hundreds of metres above the point of interception. As a result of this there occurs areal heaving with negligibly small gradients. Freezing of earth materials at the head of the water-bearing horizon is accompanied by squeezing (pressing) out of excessive (relative to the extent of porosity) quantities of water. This produces additional hydrostatic pressure in the system with a corresponding rise of the hydraulic gradient and heaving above the point of interception. In the event of a loss of velocity of the flow, increased hydrostatic pressure and continuing drop of temperatures of the earth materials, free water freezes beginning at the roof of the horizon. When blocking of the flow from the water-bearing layer occurs, the laminar flow above the point of interception may change to a turbulent flow with suspension of hard mineral admixtures, a process intensified by the presence of frazil ice in the aggregates of earth materials. During the bulk freezing of this type of mixture without any sign of the orthotropic mechanism there arises a layer of ice with suspended mineral admixtures similar to authogenic gas inclusions. Once the water-bearing stratum has been completely blocked off (being confined within its natural boundaries and boundaries superposed by freezing), there emerges a closed system with a subsequent redistribution of water and quicksand towards its weakened sector along the water-impermeable layers, and with variable velocities due to annual temperature variations. At this stage of the process there may form areas isolated hydraulically from the rest of the system, where ice formation may proceed independently. Repeated injections of this kind are accompanied by exfoliation of the layers of earth materials adfrozen to the foot of the ice formed earlier, and their subsequent inclusion into the ice in the form of xenoliths. This phenomenon is particularly characteristic of the peripheral parts of the sheet. J.R. MacKay's data (1972, pp. 17) on 200 wells from sheet deposits show good agreement with the relationship examined above between ice and enclosing soils or rocks: in 95% of cases the ice was underlain by sand or gravel, in 5% by clay; on the other hand, in 75% ice was superposed by clay or boulder loam and only in 20% by sand or gravel. The relationship between sheet deposits and subterranean pressure waters is thus obvious.

The products of cryogenic diagenesis examined above at the stage of long-distance transport, include diverse types of ground ice (segregated ice, wedge ice and injected ice) and can probably be classified as an independent cryolithological complex equivalent to the complex of mountainous countries.

The above survey of the main processes of consolidation and subaerial diagenesis of reactive components in the cryogenic zone suggests the following conclusions:

1. The main processes of mobilization, migration, accumulation and diagenesis in the cryogenic zone are typomorphic in character because of the distinctive nature of the hydrothermal factors governing these processes.
2. At the continental stages of cryolithogenesis in the direction from the water-dividing areas towards the terminal runoff basin, there have been distinctly observed two interrelated, yet opposite (with respect to their lithodynamic effect) tendencies. These trends are apparent in the matter tending to assume a state of equilibrium relative to the thermodynamic conditions in the cryogenic zone. The first tendency lies in the disintegration, dispersion and dissipation of mineral matter accompanied by endothermal effects and developing mainly according to the sandy-silty pattern. Synthesis of clay minerals in the cryogenic zone may be limited to the group of hydromicas and montmorillonite. The second tendency lies in the steadily increasing contents of ice in the products of cryogenic diagenesis, in the concentration of ice in progressively larger masses, and in the superposition (with concurrent exothermal effects) of increasingly more complex types of ice formation in the sequence: cement-ice segregated ice, wedge ice, injected ice. These distinctive individual features of the diagenesis of matter in the cryogenic zone are precisely the factors, on the basis of which cryolithogenesis has been set apart as an independent hydrothermotype of the sedimentary process.

REFERENCES

1. VTYURIN B.I. Podzemnye l'dy SSSR (Ground ice in the U.S.S.R.). Moscow, "Nauka", 212 pages, 1975.
2. GASANOV Sh.Sh. Geograficheskaya lokalizatsiya i osnovnye cherty tipomorfizma kriogenного litogeneza (Geographic localization and the main features of typomorphism in cryogenic lithogenesis). V kn.: Novye dannye po geologii Severo-Vostoka SSSR. Magadan, pp. 96-105, 1973.
3. GASANOV Sh.Sh. Kriolitogenez - fiziko-geograficheskii variant osadochnogo protsessa (Cryolithogenesis - a physico-geographic variant of the sedimentary process). V kn.: Problemy kriolitologii, Izd-vo MGU (Moscow State University Publishing House), Issue 5, pp. 23-37, 1976.
4. GRECHISHCHEV S.E. K osnovam metodiki prognoza temperaturnykh napryazhenii i deformatsii v merzlykh gruntakh (Fundamental techniques for predicting temperature stresses and strains in frozen earth materials). Moscow, 52 pages, 1970.
5. DANILOV I.D. O polozhenii kriolitogeneza v obshchei skheme polyarnogo litogeneza (The position of cryolithogenesis in the general pattern of arctic lithogenesis). II Mezhdunar. conf. po merzlotovedeniyu (II International Conference on Permafrost). Dokl. i soobshch. Issue 3, Yakutsk, pp. 23-28, 1973.
6. KATASONOV E.M. Printsipy istorizma i aktualizma v geokriologii (The principles of "historism" and "actualism" in geocryology). V kn.: Problemy geokriologii. "Nauka", Novosibirsk, pp. 19-25, 1973.
7. KONISHCHEV V.M. Kriogennoe vyvetrivanie (Cryogenic weathering). - II Mezhdunar. konf. po merzlotovedeniyu (II International Conference on Permafrost). Dokl. i soobshch. Issue 4, Yakutsk, pp. 38-45, 1973.
8. POPOV A.I. Merzlotnye yavleniya v zemnoi kore/kriolitologiya. (Phenomena caused by freezing in the earth's crust/cryolithology). Izd-vo MGU (Moscow State University Publishing House), 304 pages, 1967.
9. POPOV A.I. Kriolitogenez, sostav i stroenie merzlykh porod i podzemnye l'dy /sovremennoe sostoyanie problemy) (Cryolithogenesis, composition, structure and texture of frozen earth materials and ground ice (present-day status of the problem)). V kn.: Problemy kriolitologii. Izd-vo MGU (Moscow State University Publishing House), pp. 7-36, 1976.
10. TYUTYUNOV A.I. Protsessy izmeneniya i preobrazovaniya pochv i gornykh porod pri otritsatel'noi temperature (kriogenez) (Processes of alteration and transformation of soils and rocks at negative temperatures (cryogenesis)). Izd-vo AN SSSR (U.S.S.R. Academy of Sciences Publishing House), Moscow, 144 pages, 1960.

11. USKOV M.N. Glinistyie mineraly mnogoletnermerzlykh pleistotsenovykh i sovremennykh donnykh otlozhenii Tsentral'noi Yakutii (Clay minerals in perennially frozen Pleistocene and Recent periglacial deposits of Central Yakutia). II Mezhdunar. konf. po merzlotovedeniyu (II International Conference on Permafrost). Dokl. i soobshch. Issue 3, Yakutsk, pp. 88-92, 1973.
12. UTKIN B.V. Mekhanizm formirovaniya linzovidnogo tela v vodotokakh i gruntakh (The mechanism governing the formation of lenticular bodies in streams and earth materials). - same as above, pp. 93-95, 1973.
13. TSYTOVICH N.A. Mekhanika merzlykh gruntov (Mechanics of frozen earth materials). Moscow, "Vysshaya Shkola", 445 pages, 1973.
14. SHANTSER E.V. Ocherki o geneticheskikh tipakh kontinental'nykh osadochnykh obrazovaniy (Sketches of genetic types of continental sedimentary formations). Moscow, "Nauka", 239 pages.
15. SHILO N.A. Periglyatsial'nyi litogenez v obshchei skheme protsessa kontinental'nogo porodoobrazovaniya (Periglacial lithogenesis in the general pattern of the process of continental ice formation). V kn.: Periglyatsional'nye protsessy, Magadan, pp. 3-56, 1971.
16. MACKAY J.R. The world of underground ice. - Ann. Assoc. Am. Geogr. 62, pp. 1-22, 1972.

CYCLIC NATURE OF THERMOKARST ON THE MARITIME PLAIN  
IN THE UPPER PLEISTOCENE AND HOLOCENE

G.F. Gravis

All-Union Research Institute of Hydrology and  
Engineering Geology, Moscow, U.S.S.R.

In permafrost areas, thermokarst is one of the main factors in the formation of aggradation plains. N.A. Shilo (1964), emphasizing its great importance in the formation of the landscape and deposits of the plains of Northeast Asia, suggested that thermokarst lacustrine sedimentation should be regarded as a special type of periglacial lithogenesis. However, the history of this process has received little study, and existing views on the way in which thermokarst processes act on the sedimentary materials at different stages of development of aggradation plains is only weakly corroborated by relevant paleographic material.

At the present time, there are two basic points of view concerning the history of thermokarst. According to the first opinion, thermokarst and earth materials containing ice develop synchronically, and the age of thermokarst formations is derived in the same way as is the age of the permafrost (Kachurin, 1961). This opinion is shared by most researchers. Recently, the first data on some datings for alas\* sediments (Konishchev, 1974) have appeared; these reflect the long and complex development of thermokarst.

According to the second view, there is no temporal connection between the formation of sediment containing ice, and thermokarst (Baranova, Biske, 1964; Tomirdiaron, 1975): during the Upper Pleistocene, materials with a high ice content formed, completing the section of unconsolidated

---

\* Alas - depression with gentle slopes and flat bottom (Transl.).

sediments on the plains of Northeast Asia; in the Holocene, there was thawing of ground ice, and formation of lacustrine landscapes.

In the summer of 1973, while working on the Maritime Plain and the Novosibirsk Islands as a member of the expedition from the Permafrost Institute of the Siberian Branch of the Academy of Sciences of the U.S.S.R., the author studied a number of outcrops of sediment of the alas complex, and synchronic alluvial and maritime materials. Samples of wood and peat were taken; these were dated in the Institute's Radiocarbon Laboratory. The materials obtained allowed certain conclusions to be drawn concerning the peculiarities of thermokarst development in this region.

The diagram depicts the section of the Oyagosskii Yar\* on the southern shore of the Laptev Straits, 18 km south of the mouth of the Kondrat'evaya River. At this point the sea erodes the small monadnock of the ancient surface of the Maritime Plain (the so-called edomy\*\*) and the adjoining area of the thermokarst depression (alas).

The base of the section consists of coastal sediments containing an abundance of driftwood (cf. Fig., Va). Sedimentation took place under severe climatic conditions; this is apparent from the fine syngenetic ice veins and the primordial, arenaceous veins which formed within the tidal zone. Accumulation of marine sediments was accompanied by partial, local erosion, but thawing of the permafrost was not deep: the lower part of many fine ice veins was unaffected. Where ice wedges thawed either partially or fully, enveloping textures would form; these were first described by N.N. Romanovskii (1958). The age of the specimen of driftwood (IM-232) was given as more than 42,000 years.

There is a transition upwards through the section from coastal sediments to shallow water sediments - lagoon or lacustrine (IV). Shallow water is indicated by the rootstock of water plants and by the absence of traces of any significant taliks. It did not affect the ice-veins enclosed in the coastal sediments lying below.

---

\* Yar - steep sandy bank (Transl.).

\*\* Edomy (sing. - edoma) - type of terrain in Yakutia; eroded terraces, or ridges and low mountains (Transl.).

Lacustrine sediments in turn give way very gradually to fluvial sediments (III a, b; layer 7). Their subaerial origin is shown by the roots of herbs, buried in the very place where they had grown. There is an indistinct horizontal, and in places, horizontal, phacoidal bedding: the more arenaceous layers, or supes\* lenses up to 0.5 cm in thickness, alternate with the more silty layers, up to 0.3 cm thick. The closest present day analog of these sediments are the floodplain alluvia of the small rivers of the Maritime Plain, and on this basis, they are related to the fluvial deposits, without any inquiry into the facies conditions of their accumulation.

The spore-pollen spectra of these sediments contain 70 - 80% spores (mainly of green mosses), 10 - 20% pollens from shrubs and woody plants (birch, willow, alders, etc.), 10 - 15% herb pollens (mainly sedges and grasses) (analysis by A.M. Lisun). Their distribution is very similar to the subfossil distribution of the specimens taken from the arctic wasteland on Kotel'nii Island, with one difference; in the subfossil spectra of Kotel'nii Island there is, almost without exception, a predominance of grass pollen.

Above this, lies a complex of deposits associated with the complete cycle of formation of thermokarst depressions and their ensuing degradation, right up to the stage where they become completely filled by fluvial sedimentation. The earliest stages of the development of thermokarst are recorded by the thermodelapsing of sediments (according to M.S. Ivanov, 1972); these were formed when there was thawing and subsidence of sediments containing ice (IIId; bed 6). Their upper limit is undulating and is clearly recorded as a thin layer of densely distributed individual pockets of peat. Above these lies a bed of thermokarst lacustrine deposits. Some of the deposits thawed from the top downwards (IIc; lower part of bed 5); some of them from the bottom upwards, away from the frozen substratum (IIb; upper part of bed 5). The section of the alas complex is completed by lake-swamp sediments containing lenses and pockets of peat; and there is also thick wedge ice (IIa; bed 4). They accumulated and froze on the swampy bottom after the disappearance of the lake.

---

\* Supes - silty sand with some clay, sandy silty loam (Transl.).



The absolute age of the peat from the upper part of the bed of lake-swamp sediments is  $33,720 \pm 1500$ . According to N.V. Kind (1974), this date is that of the Karginian Interglacial period and corresponds with the final stage of the Malokhetskoe warming period. Therefore, the whole cycle of development of the thermokarst depression took place considerably earlier.

The spore-pollen spectra of lacustrine sediments does not differ from those of fluvial accumulations. From the palynological data, it has been assigned, with some certainty to the Karginian Interglacial: in the top layer of the lacustrine sediments the pollen content for woody plants and shrubs (almost invariably birch and alders) increases to 54%. Lacustrine and swamp sediments are clearly distinguished by an increase of up to 21 - 66% in the content of herb pollens (mainly due to grasses). The spore content varies within the range of 27 - 78%, the pollen content from woody plants and shrubs is from 1 to 7%. Spectra which have a similar composition are found in surface samples from water-logged habitats: the edges of alasses, the central areas of concave polygons, hollows, etc.

After this, the depression became filled with fluvial accumulations of the same type as the underlying deposits, which alternate with lacustrine, swamp accumulations (IIa; bed 2), the greater part of which were removed by slope processes. The spore-pollen spectra in bed 3 do not differ from those of the lacustrine and fluvial sediments lying below.

The thermokarst depression situated next to the edoma monadnock formed prior to the Karginian Interglacial: its age, determined by the peat from the thermodelapsing of sediments at the base of the alas complex (IIg; bed 14), turned out to be more than 42,000 years (IM-235).

The peaty lacustrine-swamp sediments (IIa; bed 11, 12), at the top of the section of the alas complex began to form after the lake had disappeared; this occurred  $5,750 \pm 200$  years (IM-230). In an outcrop in the upper part of the slope of the alas monadnock, cemetery mounds are exposed, buried beneath a layer of solifluction deposits. In the thermally eroded ravine between the cemetery mounds, there is an abundance of buried trunks and branches of shrubs, and also of herbaceous remains (VI). The age of the

remains of the shrubs was determined by the radiocarbon method as  $8,570 \pm 210$  years (IM-231). Obviously, at that time, the thermokarst depression was still occupied by a lake, along the shores of which, there was intensive erosion of the edoma.

The spore-pollen spectra of the strata containing remains of shrubs are characterized by their high content of pollen from the woody plant and shrub group (74 - 94%), mainly alders. In the younger lacustrine-swamp strata, the pollen content from the woody plant- shrub group is 6 to 7.5%; in the dominant group are herbaceous pollens (66 - 72%), mainly sedges, with some grasses, etc.

The data obtained show that the thermokarst depression examined, formed and developed considerably earlier than the Holocene. During the Holocene, the lake degraded and thermokarst development virtually ceased.

This conclusion can be reached from the analysis of radiocarbon datings of samples taken from thermokarst depressions typical of the various regions of the Maritime Plain and the Novosibirsk Islands. In all cases, the formation of peatlands which complete the section of the alas complex and encroach on the lacustrine-swamp or lacustrine sediments, began in the early Holocene (samples IM-215, 225) or even at the very end of the Upper Pleistocene (sample IM-227) (Table).

In Holocene deposits there is typically, at most, only one horizon containing remains of woody plants and shrubs. In thermokarst depressions containing no lake at the present time, it is restricted to the uppermost lacustrine sediments or to the lower part of the peatlands covering them around the bottom. The absolute ages of the woody remains are very close:  $8,570 \pm 210$  to  $9,320 \pm 200$  years (Im-215, 225, 231). It is to this very time interval that the thin layer of peat in the solifluction accumulation on the 12 to 14 metre bench of the marine terrace on Kotel'nyi Island belongs; this indicates that solifluction ceased temporarily. Therefore, on the Maritime Plain, as in Alaska, on Kamchatka and Sakhalin (Kind, 1964, p. 229), the climatic optimum falls at the beginning of the Holocene. However, the formation of the large thermokarst depressions was already completed by this time.

The gradual disappearance of thermokarst in the Holocene was paralleled by a lowering of the sea level after the maximum transgression at the beginning of the Holocene (date IM-218 to  $9,660 \pm 220$  years from the upper horizon of the 8 metre marine terrace in the south of Bol'shoi Lyakhov Island), and by the carving of river valleys. From the upper horizon of the alluvium forming terrace 1 above the flood-plain of the Saan-Yurekh River (the terrace is relatively uniform in height and is level with the highest point of the thermokarst depression) the date  $8,270 \pm 200$  years (IM-222) was obtained; the high floodplain has a date  $3,460 \pm 200$  years (IM-221). The process of reduction of the lakes and formation of swamp sediment containing ice at the bottom of alasses is still continuing (IM-219 and 223). Of course, the high stand of the sea level caused inundation of negative landforms and intensive thermokarst development. With the fall in the sea level and the lowering of lake levels, the intensity of permafrost degradation diminished.

The data examined above allows us to conclude that on the Maritime Plain and the Novosibirsk Islands, thermokarst develops without interruption, simultaneously with the formation of deposits containing ice; however, its intensity fluctuates. At least, for the period embracing the second half of the Upper Pleistocene and the Holocene, thermokarst development is mainly characteristic of cold glaciation epochs (the Zyrian and the Sartan epochs). A decrease in intensity of thermokarst coincides with the relatively warmer periods (Karginian, Interglacial, Holocene).

It appears that changes in the degree of surface inundation, associated fluctuations in climate, and fluctuation in sea level (the main base level of erosion) form the basic, most common factor in determining the fluctuating rate of thermokarst. Marine transgression furthers increased inundation of the plain and consequently intensification of thermokarst.

Thus thermokarst develops cyclically and, hypothetically, it takes place as follows. Each cycle of thermokarst embraces two related periods of cooling and warming of the climate, namely glaciation-interglaciation, and is divided into four parts.

Stage I - time of the cold, moist climate of the first half of the Ice Age. In this period, cryogenic weathering of rocks, activity of snows and glaciers, and slope processes are active in transportation. There is a sharp increase in the quantity of unconsolidated material reaching the rivers. As a result, despite the lowering of the sea level, there is increased accumulation in the valleys, especially at the heads of streams and in places where there is a decrease in gradient i.e., in deltas; at points where rivers leave the mountains; in places where they cross negative landforms (including thermokarst basins). There is a tendency to a wearing down of the plain, to the filling of thermokarst depressions with fluvial (and partly slope) accumulation. Having possibly intensified at the beginning of this stage, thermokarst development later gave way to sedimentation.

Stage II - time of the cold, dry climate of the second half of the Ice Age. The intensity of disintegration of earth materials and of transportation of coarse materials decreases and, as a result, under the conditions of low sea level, erosion-denudation begins. It impedes accumulation of water on the plain and thus inhibits the development of thermokarst.

Stage III - the end of glaciation epochs. The rise in sea level intensified inundation of negative landscape features which existed earlier and had not been completely filled with sediments during the first stage, or which had appeared again during the second stage. As a result of this, intense development of thermokarst takes place.

Stage IV - interglacial, postglacial age. As a result of a certain degree of lowering of the sea level under conditions of relatively little slope process activity, there is erosion and thermal erosion of the plain; a lowering of lake levels; and a consequent reduction in intensity of thermokarst development.

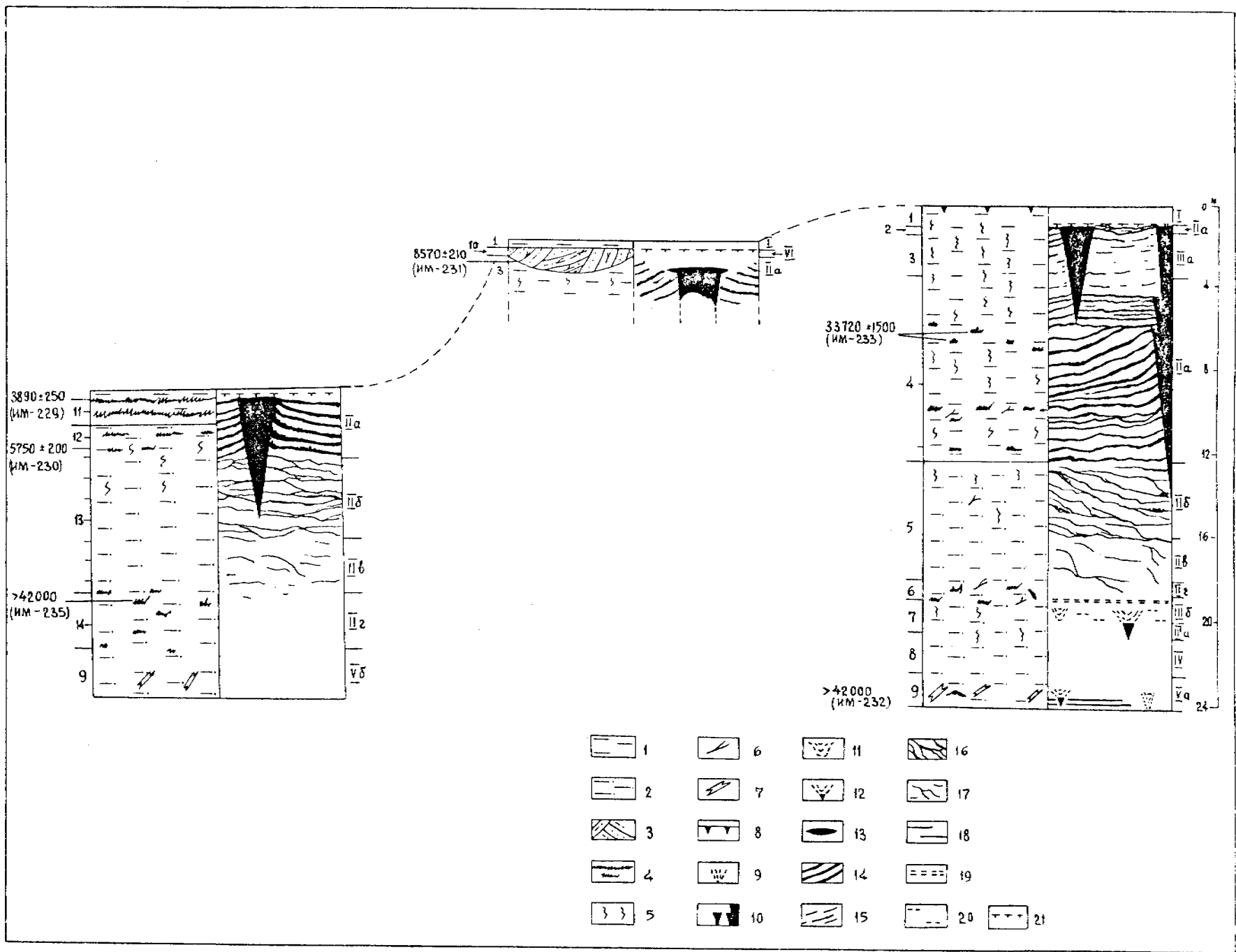

Cryolithological Section of the Quarternary Deposits  
in the Outcrop on the Oyagosskii Yar.

Left - lithological section;  
Right - column of permafrost structure.

1 - heavy supes; 2 - light supes; 3 - oblique, phacoidal crossbedding of supes and fine sand; 4 - intercalations, lenses and pockets of peat; 5 - roots of herbs, and rootstock of water plants; 6 - remains of shrubs; 7 - driftwood; 8 - wedges of peat in frost fissures between seasonal frost mounds; 9 - primordial arenaceous veins; 10 - ice wedges; 11 - envelopping textures formed during total subaqueous thawing of ice wedges; 12 - as 11, but only partial thawing; 13 - lenses of injected ice, cryogenic textures formed by freezing from below; 14 - concave-laminar, reticulate; 15 - concave-sporadic-laminar, phacoidal; 16 - cross bedded, cryogenic structures, formed by freezing from above; 17 - cross-bedded; 18 - horizontal-sporadic-phacoidal "postcryogenic structure"\*; 19 - horizontal-laminar; 20 - phacoidal; 21 - upper surface of permafrost.

Genesis of deposits (columns with Roman numerals indicate cryogenic structure); I - solifluction deposits formed during disintegration of the edoma. Alas complex: II a - lake-swamp deposits, frozen from below; II b - thermokarst lake deposits frozen from below; II c - the same, but frozen from above; II d - thermodelapsing deposits (frozen from above), fluvial deposits; III a - frozen from below; III b - thawed in a sublacustrine talik and refrozen from above; IV - sediments of shallow lagoons or lakes, off-shore marine deposits; V a - frozen from above, partially thawed during accumulation and again frozen from above; V b - thawed under thermokarst lakes and then frozen from above; VI - talus at the bottom of a thermally eroded ravine.

Composition and structural peculiarities of deposits. (Arabic numerals indicate lithological section): 1 - heavy-supes, brown patterns on a bluish, dark gray ground, non-laminar; 2 - heavy supes, non-laminar, bluish, dark gray, non-laminar, with pockets of autochthonous peat and rootstock of herbs; 3 - heavy supes, gray with brownish hues, non-laminar, densely penetrated by roots of herbs; 4 - heavy supes, bluish dark-gray to gray non-laminar, with pockets and lenses of authochthonous peat, with roots of herbs; 5 - light supes, light gray in colour; in the upper part of the layer there is clearly observable fine (1-2 mm) phacoidal bedding due to the varied content of arenaceous materials and allochthonous vegetal detritus containing a large quantity of roots of herbs, twigs from shrubs; below this, the supes becomes more homogeneous, the bedding and roots of herbs disappear, penetrating only rarely and indistinctly, shallow pockets of peat; 6 - light supes, gray, with traces of buckling; in places, there are blocks, in the nucleus of which, the original horizontal bedding is preserved; towards the periphery of the blocks, the layers curve upwards or downwards; in the lower part of the layer, there is an undulating intercalation of individual crumbling clods of decomposing peat; 7 - light supes, gray, with ill defined horizontal bedding: layers which are more arenaceous and are about 0.5 cm

---

\* Structure acquired by thawed earth materials as a result of melting of ice in pores and voids (Transl.).

thick alternate with the more silty layers (0.3 cm), occasional penetration by vegetal detritus, a large amount of roots of herbs; 8 - light supes, gray, with brown patches, and with distinct horizontal bedding (thickness of layer 0.5 to 1.0 cm); there is vegetal detritus and rootstock of water plants, all vegetal remains are encrusted with supes cemented with iron oxides; 9 - light supes, bluish dark-gray to gray, horizontally bedded with individual lenticules of fine-grained sand, with frequent intercalations of vegetal detritus, with lenses of allochthonous peat and driftwood; 10 - oblique, phacoidal cross-bedding of supes and fine-grained sand; also contains remains of grasses, sedges, etc.; 11 - heavy supes, bluish dark-gray to gray, peaty, with lenses and intercalations of autochthonous peat with a thickness of up to 18 cm; 12 - light supes, bluish dark-gray to gray, peaty, with lenses and pockets of peat, the quantity and dimensions of which decrease with depth; 13 - light supes, bluish dark-gray to gray, cryptolaminar, in the upper part of the layer are rootstocks and other remains of water plants; 14 - light supes, bluish dark-gray to gray with shallow and crumbing lenses of autochthonous peat.

The smaller the thermokarst depression, under similar conditions, the more apparent is the cyclic nature of the thermokarst. As the dimensions of the thermokarst forms increase, the stronger is the tendency for the processes to be repeated. Local adjustments of the cyclic processes are introduced by coincident tectonic movements of the Earth's crust. In morphostructures which are undergoing intense development, the cyclic nature of the thermokarst can be completely inhibited; on positive features - on account of constant severe denudation of the surface: on the negative features - because of constant inundation.

Radiocarbon Dating of a number of sections of Quarternary Deposits  
of the Maritime Plain and the Novosibirsk Islands

Sample No.	Occurrence	Depth of extraction	Composition of sample, layer from which extracted	Radiocarbon dates
IM-228	Kotel'nyi Island, east cost of Stekhanovsk Bay in the Arctic, bench II of the marine terrace (height 12-14 m)	0.50 - 0.60	Peat from the 10 cm intercalation in solifluction deposits covering marine sediments	8,440 ± 200
IM-217	Bol'shoi Lyakhovsk Island, south shore in the region of the mouth of the Dymnaya River, outcrop II of the marine terrace (height 8 m)	5.00	Encrusted driftwood from the lower horizon in offshore deposits	>42,000
IM-218	as above	0.75	Encrusted driftwood from the upper horizon in offshore deposits	9,660 ± 200
IM-215	As above, rear of the same terrace, peat mound	0.70 - 0.80	Driftwood from the base of the peat mound	9,220 ± 200
IM-214	as above	0.005 - 0.15	Peat from the upper layer of the peat mound	8,340 ± 200
IM-219	Maritime Plain, near Uryung-Khastakh Mt., bottom of the thermokarst depression, polygonal peat mound	0.00	Peat from the surface of the rim. (height 1m) bordering a polygon with enlarging ice wedges	2,510 ± 175
IM-220	As above, outcrop of the alas complex on the banks of small rivers intersecting the thermokarst depression	0.60	Wood from the upper horizon of lacustrine sediments filling the thermokarst depression	9,120 ± 220



IM-221	Maritime Plain upper reaches of the Saan-Yurekh R., high floodplain (relative height 1.5 m)	1.10	Intercalation of allochthonous peat in fluvial alluvium	3,460 ± 200
IM-222	As above, 1st terrace (relative height 6 m)	0.75	Intercalation of autochthonous peat in flood plain alluvium	8,270 ± 200
IM-225	Maritime Plain, region of Khamnaann'a Mt., side of thermokarst depression, peat mound	1.80 - 1.90	Wood from the base of the peat mound	9,320 ± 200
IM-224	As above	0.20	Peat from the upper layer of the peat mound	7,670 ± 200
IM-223	As above, central part of the same thermokarst depression, top of the perennial frost mound	0.00	Peat	715 ± 160
IM-227	As above, side of another thermokarst depression, peat mound	4.40	Peat from base of peat mound	11,870 ± 250
IM-226	As above	0.20	Peat from upper of peat mound	4,590 ± 250

REFERENCES

- BARANOVA, Yu.P. and BISKE, S.F. Severo-Vostok SSSR (Istoriya razvitiya rel'efa Sibiri i Dal'nego Vostoka). (North-East U.S.S.R. (Historical Development of the Relief of Siberia and the Far East)). M., "Nauka", p. 290, 1964.
- IVANOV, M.S. Tipy i fatsii termokarstovykh otlozhenii Tsentral'noi Yakutii. (Types and Facies of the Deposits of Central Yakutiya). -In the book: Problemy izucheniya chetvertichnogo perioda. (Problems of the Quarternary). M., "Nauka", pp. 83-89, 1972.
- KACHURIN, S.P. Termokarst na territorii SSSR. (Thermokarst in the U.S.S.R.). M., Izd-vo AN SSSR, p. 290, 1961.
- KIND, N.V. Geokhronologiya pozdnego antropogena po izotopnym dannym. (Geochronology of the Late Quarternary according to Isotopic Data). (Trudy Geologich. in-ta AN SSSR, vyp. 257). M., "Nauka", p. 255, 1974.
- KONISHCHEV, V.N. Vozrast podzemnykh l'dov Yano-Indigirskoi izmennosti. (Age of Underground Ice of the Yana-Indigirka Plain). In the book: Problemy kriolitologii (Problems of Cryolithology), vyp. 4. Izd-vo MGU, pp. 110-115, 1974.
- ROMANOVSKII, N.N. Merzlotnye struktury oblekaniya v chetvertichnykh otlozheniyakh. (Permafrost Envelopping Textures in Quarternary Deposits). -Nauch. dokl. vysh. shkoly. Geologo-geo. nauki, No. 3, pp. 185-189, 1958.
- TOMIRDIARO, S.V. Kriogennaya evolutsiya ravnin Severo-Vostoka Asii v pozdnem lednikov'e i golotsene. (Cryogenic Evolution of the Plains of Northeast Asia in the Ice Age and the Holocene). -Izv. Vsesoyuz. geograf. ob-va, Vol. 107 vyp. 2, 1975.
- SHILOV, N.A. K istorii razvitiya nizmennostei subarkticheskogo poyasa Severo-Vostoka Asii. (Historical Development of the Plains of the Subarctic Region of Northeast Asia). -In the book: Tektonika i glubinoe stroenie Severo-Vostoka SSSR. (Tectonics and Deep Structure of Northeast U.S.S.R.) Trudy Sev. -Vost. kompl. n. -i. in-ta SO AN SSSR, vyp. 11, Magadan, pp. 154-169, 1964.



SOME ASPECTS OF THE MECHANICS OF FROST FRACTURING  
OF SOILS IN THE PERMAFROST ZONE

S.E. Grechishchev

All-Union Research Institute of Hydrogeology and Engineering Geology  
Moscow, U.S.S.R.

For the resolution of some scientific and practical geocryological problems it is necessary to predict the geometric parameters of frost fractures. The latter are formed in soils in permafrost regions as a result of the freezing of the surface during the winter. These fractures, emerging onto the surface of the soil, form a periodic, generally rectangular or close-to-rectangular system, termed fracture polygons, on the plane surface. Among the geometric parameters of frost fractures are the width of the opening, their depth and the distance between neighbouring fractures (length of polygons). The determination of these values may be carried out by methods of the mechanics of continuous deformable media.

During the winter in the permafrost regions the soil is frozen to a depth greater than the depth of the frost fracturing, for purposes of calculation the frost fractures may be schematized as equilibrium fractures of a normal rupture, emerging onto the surface perpendicular to the boundary of a continuous semispace with prescribed mechanical properties. In this case, for the calculation of the depth of the equilibrium fractures one may utilise Irwin and Barenblatt's condition of strength at the apex of a fracture (Barenblatt, 1950; Cherepanov, 1974; Razrushenie, 1975).

$$k_I = K_{Ic} \quad (I)$$

where  $k_I$  - coefficient of the intensity of normal stresses in the apex of the fracture,  $K_{Ic}$  - a physical constant - the viscosity coefficient of failure in the apex of a fracture of a normal rupture.

To determine the coefficient of the intensity of stresses,  $k_1$ , it is necessary to have a solution concerning the distribution of stresses around the fracture. Since around the fracture there is formed a zone of relief (Lachenbruch, 1962), within which the stresses are found to be below the limit of the long-term strength (Grechishchev, 1962), the determination of the stresses may be carried out if one makes the simplifying assumption that the frozen soil works as an elastic medium.

Let us consider the solution to the problem of the thermoelastic state in the vicinity of two marginal fractures in a half-space. The boundary conditions of this problem have the form (Figure 1):

$$\begin{aligned}
 1. \quad & y = 0; \quad \sigma_y^0 = r_{xy}^0 = 0, \\
 2. \quad & x = -1, \quad 0 \leq y \leq h_1; \quad \sigma_x^0 = r_{xy}^0 = 0, \\
 3. \quad & x = +1, \quad 0 \leq y \leq h_2; \quad \sigma_x^0 = r_{xy}^0 = 0,
 \end{aligned}
 \tag{2}$$

where  $\sigma_x^0$ ,  $\sigma_y^0$ ,  $r_{xy}^0$  - stress components;  $h_1$  and  $h_2$  - depth of first and second fractures;  $2l$  - distance between fractures.

Figure 1

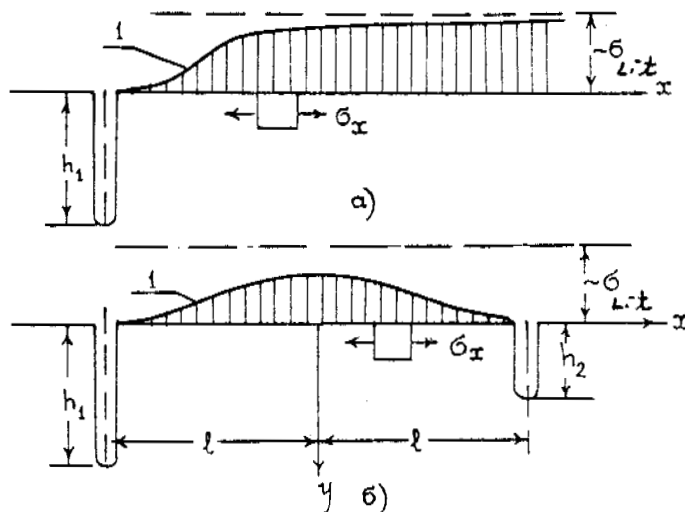

Schematic diagram for the calculation of the thermal-stress state of a block with fractures:

a) - for a single fracture, b) - for two fractures;

1 - schematic curve of the thermal stresses  $\sigma_x$  close to the surface of the soil  $y = 0$ .

Let us represent  $\sigma_{ik}$  ( $i, k = x, y$ ) in the form of the sum of the known stresses  $p_{ik}$  in a continuous (without fractures) half-space with the same temperature field and certain additional stresses  $\sigma_{ik}$ , i.e.,

$$\sigma_{ik}^{\circ} = p_{ik} + \sigma_{ik}, \quad (i, k = x, y). \quad (3)$$

Then the field of the additional stresses should be determined on the basis of (2) with the following boundary conditions:

$$\begin{aligned} 1. \quad & y = 0; \quad \sigma_y = \tau_{xy} = 0, \\ 2. \quad & x = -1, 0 \leq y \leq h_1; \quad \sigma_x = -p_{x1}(y), \quad \tau_{xy} = 0, \\ 3. \quad & x = +1, 0 \leq y \leq h_2; \quad \sigma_x = -p_{x2}(y), \quad \tau_{xy} = 0, \end{aligned} \quad (4)$$

where  $p_{x1}$ ,  $p_{x2}$  - stresses in the continuous (without fractures) half-space on the lines coinciding with the contours of the first and second fractures.

For the case, which is important in practice, of fractures that are located at a distance from one another ( $h_1/2l < 1$ ,  $h_2/2l < 1$ ) we will present equations, which we obtained by Kolosov and Muskhelishvili's method (Muskhelishvili, 1966), for determining the coefficients of the intensity of stresses in the apexes of the fractures, the width of the opening of the fractures and the normal additional stresses tangential to the surface  $y = 0$ .

The equations for the coefficients of intensity of the stresses are:

$$\left. \begin{aligned} k_{1h_1} &= \frac{1}{\pi} \sqrt{2\text{ch}_1^c - 1} \int_0^{h_1} \frac{p_{x1}(t) - 4\lambda_2^2 C_2}{\sqrt{h_1^c - t^c}} dt \\ k_{1h_2} &= \frac{1}{\pi} \sqrt{2\text{ch}_2^c - 1} \int_0^{h_2} \frac{p_{x2}(t) - 4\lambda_1^2 C_1}{\sqrt{h_2^c - t^c}} dt \end{aligned} \right\} \quad (5)$$

where  $k_{1h_1}$ ,  $k_{1h_2}$  - coefficients of intensity of the stresses at the apex of the first and second fractures respectively:

$$\begin{aligned} &= h_1/2l; \quad \lambda_2 = h_2/2l; \quad c = 2\pi^2/(\pi^2 - 4) \approx 3,37; \quad C_1 = (I_1 - 4\lambda_2^2 a_1 I_2) / \\ &/ (1 - 16\lambda_1^2 \lambda_2^2 a_1 a_2); \quad C_2 = (I_2 - 4\lambda_1^2 a_2 I_1) / (1 - 16\lambda_1^2 \lambda_2^2 a_1 a_2); \end{aligned}$$

$$I_k = \frac{2c}{\pi^2 h_k^2} \int_0^{h_k} \int_0^{h_k} \frac{y^c \sqrt{h_k^c - s^c} p_{xk}(s) ds dy}{\sqrt{h_k^c - y^c} (y^c - s^c)}, \quad (k=1,2),$$

$$a_k = \frac{2c}{\pi^2 h_k^2} \int_0^{h_k} \int_0^{h_k} \frac{y^c \sqrt{h_k^c - s^c} ds dy}{\sqrt{h_k^c - y^c} (y^c - s^c)}, \quad (k=1,2).$$

The equations for determining the width of the opening of the fractures are:

$$\left. \begin{aligned} \frac{E_{L-t}^p \cdot S_1}{4(1-\nu^2)} &= \frac{c}{\pi} \sqrt{h_1^c - y^c} \int_0^{h_1} \frac{Q_{x1}(t) t^{c-1} dt}{\sqrt{h_1^c - t^c} (t^c - y^c)}, \quad 0 \leq y \leq h_1 \\ \frac{E_{L-t}^p \cdot S_2}{4(1-\nu^2)} &= \frac{c}{\pi} \sqrt{h_2^c - y^c} \int_0^{h_2} \frac{Q_{x2}(t) t^{c-1} dt}{\sqrt{h_2^c - t^c} (t^c - y^c)}, \quad 0 \leq y \leq h_2 \end{aligned} \right\} (6)$$

where  $S_1, S_2$  - width of opening of the first and second fractures respectively;  $E_{L-t}^p$  - limiting long-term modulus of deformation with tension;  $\nu$  - Poisson's coefficient:

$$Q_{x1}(t) = \int_0^t [p_{x1}(s) - 4\lambda_2^2 C_2] ds;$$

$$Q_{x2}(t) = \int_0^t [p_{x2}(s) - 4\lambda_1^2 C_1] ds.$$

The equation for determining the normal additional stresses tangential to the surface  $y = 0$  is:

$$\sigma_x|_{y=0} = -\frac{8c}{\pi^2} \int_0^{h_1} \int_0^{h_1} \frac{(1+x)^2 y^c \sqrt{h_2^c - s^c} [p_{x1}(s) - 4\lambda_2^2 C_2] ds dy}{[(1+x)^2 + s^2]^2 \sqrt{h_1^c - y^c} (y^c - s^c)} -$$

$$-\frac{8c}{\pi^2} \int_0^{h_2} \int_0^{h_2} \frac{(1-x)^2 y^c \sqrt{h_2^c - s^c} [p_{x2}(s) - 4\lambda_1^2 C_1] ds dy}{[(1-x)^2 + s^2]^2 \sqrt{h_2^c - y^c} (y^c - s^c)}. \quad (7)$$

With  $\lambda_1 = \lambda_2 = 0$  expressions (5) - (7) coincide with the solutions for a single fracture, obtained in previous studies (Karpenko, 1965; Savruk, 1975).

Below we will consider the most frequently encountered case of fractures that are of the same depth, i.e., in equations (5) - (7) we will assume  $h_1 = h_2$ .

For frost fractures the load  $p_x(y)$ , included in equations (5) - (7) and representing the stresses in the undisturbed (without fractures) half-space, is the sum of the temperature stresses  $p_x^t(y)$  and of the stresses of the intrinsic weight of the soil  $p_x^y(y)$ , i.e.,

$$p_x(y) = p_x^t(y) + p_x^y(y). \quad (8)$$

Let us consider the effect of each of the components of these stresses separately.

The thermal tensile stresses  $p_x^t(y)$  in an elastic half-space with a load-free boundary may be calculated according to the well-known equation:

$$p_x^t(y) = -\frac{E_{L,t}^P(t) \alpha_\infty(t) \cdot t}{1-\nu} \leq \sigma_{L,t}^P \quad (9)$$

where  $\alpha_\infty(t)$  - coefficient of a stabilized temperature deformation with a lowering of the temperature from  $-2^0$  to  $t$ ;  $t$  - absolute value of the negative temperature in  $^0C$ ;  $\sigma_{L,t}^P$  - limit of the long-term strength with stretching of the frozen soil.

The characteristics of frozen dispersed soils  $\alpha_\infty$  and  $E_{L,t}^P$  are dependent on the temperature. At a temperature below  $-2^0C$  their relationship to the temperature may be represented by the following empirical expressions, which are in satisfactory agreement with the experimental data that were cited in a previous study (Grechishchev, 1971):

$$\left. \begin{aligned} E_{L,t}^P &= E_0(1 + \beta_E t) \\ \alpha_\infty &= \alpha_0(1 + \beta_\alpha / \sqrt{t}) \end{aligned} \right\} \quad (10)$$

where  $E_0$ ,  $\beta_E$ ,  $\alpha_0$ ,  $\beta_\alpha$  - empirical values.



Let us assume that the temperature of the soil surface during the winter  $t_{\pi}$  changes according to the periodic principle:

$$t_{\pi} = t_{01} \sin \omega_1 r, \quad (11)$$

where  $t_{01}$  - mean minimal temperature of the soil surface during the coldest month;  $\omega_1 = 0.2 \cdot 10^{-6} \text{ 1/c}$  - frequency of temperature fluctuations, corresponding to a period equal to the duration of the winter;  $r$  - time.

Then for approximate computations the temperature of the soil may be calculated according to the well-known equation:

$$t = t_{01} e^{-\mu_1 y} \sin(\omega_1 r - \mu_1 y), \quad (12)$$

where  $\mu_1 = \sqrt{\omega_1 / 2a_M}$ ;  $a_M$  - coefficient of thermal diffusivity of the frozen soil.

Expression (12) will be the more accurate the further north the region is located from the southern boundary of the permafrost zone.

We may present expression (9) with the help of the empirical relationships (10) in the following form:

$$p_x^t(y) = \frac{E^P (t_{01}) a_{\infty} (t_{01}) \cdot t_{01}}{1 - \nu} \cdot \frac{1 + \beta_E t}{1 + \beta_E t_{01}} \cdot \frac{1 + \beta_{\alpha} / \sqrt{t}}{1 + \beta_{\alpha} / \sqrt{t_{01}}} \cdot \frac{t}{t_{01}} \quad (13)$$

In practice we have established, on the basis of data that are available to us, that for a wide range of frozen sandy-clay and peat soils the following conditions are always observed:

$$\frac{1}{\beta_E t_{01}} < 0,15; \quad 0,2 < \frac{1}{1 + \sqrt{t_{01}} / \beta_{\alpha}} < 0,8$$

These conditions allow us to introduce the approximation

$$\frac{1 + \beta_E t}{1 + \beta_E t_{01}} \cdot \frac{1 + \beta_a / \sqrt{t}}{1 + \beta_a / \sqrt{t_{01}}} \approx 0,2 + 0,8 \cdot \frac{t}{t_{01}}, \quad (14)$$

the error of which in the range of  $-2^0 \leq t \leq t_{01}$  does not exceed 10%. Thus equation (13) may be given the following form

$$p_x^t(y) \approx \frac{E_{L-t}^p(t_{01}) \alpha_{\infty}(t_{01}) \cdot t_{01}}{1 - \nu} \left(0,2 + 0,8 \frac{t}{t_{01}}\right) \frac{t}{t_{01}} \quad (15)$$

Let us take into consideration also the following circumstance. The occurrence of fractures is possible only in the case when the temperature stresses close to the surface of the continuous block of soil exceed the limit of the long-term tensile strength. Calculations show that such exceeding, as a consequence of the viscous and plastic properties of the soil, turns out to be one or two orders of magnitude smaller than the limit of the long-term strength. At the surface of the soil, therefore, with  $y = 0$  and  $t = t_{01}$ , the temperature stresses may be taken as being equal to the limit of the long-term tensile strength, i.e.,

$$p_x^t(0) \approx \sigma_{L-t}^p(t_{01}), \quad (16)$$

where  $\sigma_{L-t}^p(t_{01})$  - limit of the long-term tensile strength of the frozen soil at a temperature of  $t_{01}$ .

Taking this into consideration, expression (15) may be written in the form of the following definitive approximation:

$$p_x^t(y) \approx \sigma_{L-t}^p(t_{01}) \cdot \left(0,2 + 0,8 \frac{t}{t_{01}}\right) \frac{t}{t_{01}}, \quad (17)$$

where  $t$  is determined by equation (12).

The stresses from the intrinsic weight of the soil in a continuous half-space are determined by the well-known expressions:

$$p_y^y(y) = -\gamma y; p_x^y(y) = -\frac{\nu}{1-\nu}\gamma y, \quad (y > 0). \quad (18)$$

Since these stresses, in contrast to the temperature stresses, are compressive and with compression of frozen soils  $\nu \approx 0.5$ , then it may be assumed in approximation that:

$$p_x^y(y) \approx -\gamma y. \quad (19)$$

By substituting expressions (19), (17) and (12) into (8) and then into (5) - (7) and by employing numerical methods for calculating the integrals, it is possible to calculate the unknown parameters of the frost fractures. Omitting the details of the calculation, we will present some results for the case of fractures of the same depth, assuming in equations (5) - (7) that  $h_1 = h_2 = h$ ,  $\lambda_1 = \lambda_2 = \lambda = h/2l$ .

Figure 2

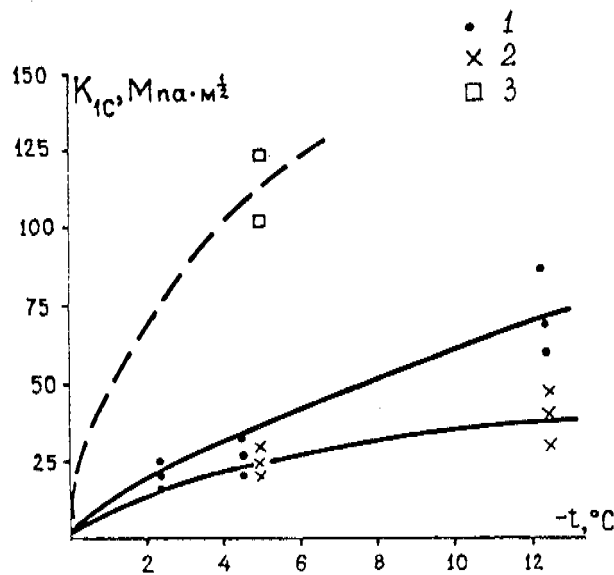

Relationship between the viscosity coefficient of failure  $K_{IC}$  and the temperature of frozen soils.  
 1 - sand with  $W = 10 - 17\%$ ; 2 - supes with  $W = 20 - 25\%$ ;  
 3 - peat with  $W = 300\%$  ( $W$  - total moisture content by weight).

Calculation of the depth of frost fractures

Experimental data available to us (Figure 2) allow us to establish that the viscosity coefficient of failure  $K_{1c}$ , included in expression (11), is approximately proportional to the square root of the absolute value of the negative temperature in  $^{\circ}\text{C}$ . Thus we may approximately assume:

$$K_{1c} \approx \frac{1}{\pi} K_0 \sqrt{t + t_{cp}}, \quad (20)$$

where  $K_0$  - an empirical constant;  $t$  - temperature, determined by equation (12);  $t_{cp}$  - mean annual temperature of the soil.

Using condition (1), expression (20) and a numerical integration according to equations (5), we may obtain an equation for determining the depth of frost fractures in the middle of winter (assuming  $\omega r = \pi/2$  in equation (12)).

$$\bar{\sigma} \cdot \bar{k}_c^t(\mu_1 h, \lambda) - \bar{k}_1^y(\mu_1 h, \lambda) = \bar{K} \cdot \bar{K}_c(\mu_1 h, t_{cp}/t_{01}) \quad (21)$$

and at the end of winter (assuming  $\omega r = \pi$  in equation (12)).

$$\bar{\sigma} \bar{k}_k^t(\mu_1 h, \lambda) - \bar{k}_1^y(\mu_1 h, \lambda) = \bar{K} \cdot \bar{K}_k(\mu_1 h, t_{cp}/t_{01}), \quad (22)$$

where

$$\bar{\sigma} = \mu_1 \sigma_{L:k}^p(t_{01})/\gamma \quad (23)$$

$$\bar{K} = K_0 \sqrt{t_{01}} \cdot \mu_1^{3/2}/\gamma. \quad (24)$$

The values of functions  $\bar{k}_c^t$ ,  $\bar{k}_1^y$ ,  $\bar{k}_k^t$ ,  $\bar{K}_c$  and  $\bar{K}_k$  are presented in Table I and II. In Table I the last column refers to a single fracture.

The determination of the depth of the fracture from equations (21) and (22) may be carried out, for example, by a graphical method making use of Table I and II. As an example we will present the results of calculations based on this equation with  $\bar{K} = 10$  and  $t_{cp}/t_{01} = 0.1$  (Figure 3). As is evident in Figure 3, the calculated relationships between  $\mu_1 h$  and  $\bar{\sigma}$  have two branches: a descending and an ascending branch with points of inflection at

TABLE I

$\mu_1 h$	$\lambda$							
	0,40	0,35	0,25	0,15	0,10	0,07	0,05	0
	Function $\bar{k}_c^t$							
0,2	0,27	0,30	0,35	0,39	0,40	0,41	0,41	0,41
0,5	0,30	0,33	0,40	0,45	0,47	0,48	0,48	0,48
1,0	0,21	0,24	0,32	0,37	0,39	0,40	0,40	0,41
2,0	0,07	0,24	0,16	0,18	0,20	0,23	0,24	0,25
3,0	0,02	0,02	0,04	0,06	0,07	0,08	0,08	0,10
	Function $\bar{k}_k^t$							
0,2	0,02	0,02	0,02	0,02	0,02	0,02	0,02	0,02
0,5	0,05	0,05	0,06	0,07	0,07	0,07	0,07	0,07
1,0	0,10	0,11	0,12	0,13	0,14	0,14	0,14	0,14
2,0	0,07	0,06	0,11	0,12	0,13	0,13	0,13	0,13
3,0	0,01	0,02	0,03	0,05	0,06	0,07	0,07	0,07
	Function $\bar{k}_l^y$							
0,2	0,05	0,05	0,05	0,06	0,06	0,06	0,06	0,06
0,5	0,19	0,20	0,22	0,23	0,24	0,24	0,24	0,24
1,0	0,54	0,57	0,61	0,65	0,67	0,67	0,68	0,68
2,0	1,52	1,61	1,72	1,83	1,89	1,89	1,92	1,92
3,0	2,80	2,96	3,17	3,37	3,48	3,48	3,53	3,53

$\mu_1 h = 0.7$  to  $0.9$ . It is interesting to note that this value of  $\mu_1 h$  at the points of inflection is preserved for any  $\bar{K}$ ,  $\lambda$  and  $t_{cp}/t_{01}$ , which was ascertained by us by means of direct calculations.

TABLE II

$t_{cp}/t_{01}$	$\mu_1 h$				
	0,2	0,5	1,0	2,0	3,0
Function $\bar{K}_c$					
0,05	0,28	0,24	0,15	0,07	0,06
0,1	0,29	0,25	0,17	0,10	0,09
0,2	0,31	0,27	0,20	0,14	0,13
0,5	0,35	0,32	0,26	0,23	0,22
Function $\bar{K}_k$					
0,05	0,15	0,19	0,19	0,14	0,07
0,1	0,16	0,20	0,20	0,16	0,10
0,2	0,19	0,23	0,22	0,18	0,14
0,5	0,26	0,28	0,29	0,26	0,23

Figure 3

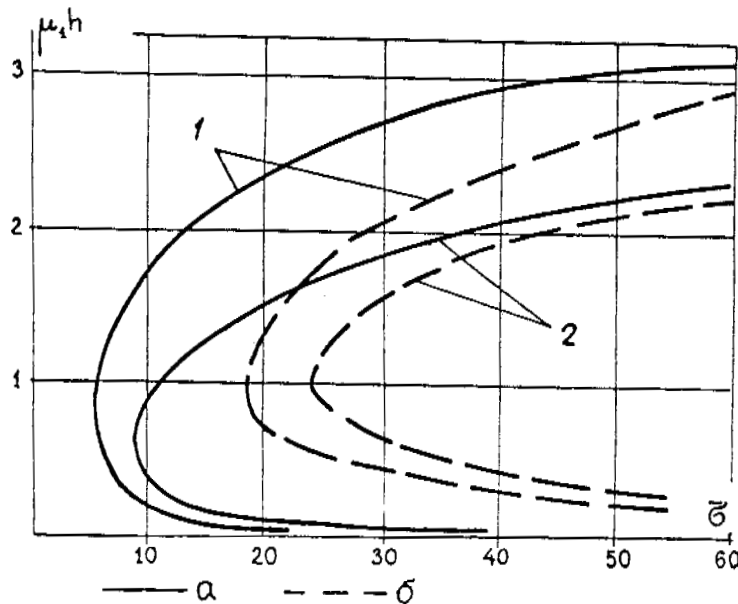

The relationship between the depth of frost fractures  $\mu_1 h$  and the dimensionless stresses  $\bar{\sigma}$  with  $\bar{K} = 10$  and  $t_{cp}/t_{01} = 0.1$ :  
 1 - for a single fracture ( $\lambda = 0$ ); 2 - in the presence of a neighbouring fracture at a distance of  $2.5 \mu_1 h$  from the first fracture ( $\lambda = 0.4$ ); a - in the middle of winter; b - at the end of winter.

The descending branch is characterized by the condition

$$dh/d\bar{\sigma} < 0,$$

which corresponds to the condition of instability of an equilibrium fracture. For the ascending branch

$$dh/d\bar{\sigma} > 0,$$

i.e., the fractures defined by this branch should be stable. If one takes into consideration that practically for any soils  $\mu_1 = 0.33$  to  $0.40$  l/m, then this means that the depth of the fractures growing in winter cannot be less than  $\sim 1.7$  m. From this it also follows that for determining the depth of fractures one should utilize only the upper ascending branches of the curves.

An examination of the graphs in Figure 3 also shows that the frost fractures close up partially or even completely towards the end of the winter. For example, if the physical properties of the soil are characterized by the values  $\bar{K} = 10$  and  $\bar{\sigma} = 30$ , then according to Figure 3 the depth of a single fracture in the middle of winter comprises  $\mu_1 h = 2.7$ , while at the end of winter this value is  $\mu_1 h = 2.0$ . If however, for example, the physical constants of the soil would be  $\bar{K} = 10$  and  $\bar{\sigma} = 15$ , then a single fracture in the middle of winter would have a depth  $\mu_1 h = 2.1$ , while at the end of winter this fracture would close up completely (the line for  $\bar{\sigma} = 15$  lies to the left of the curve  $\mu_1 h - \bar{\sigma}$  for the end of the winter). Theoretically, therefore, fractures that exist only during the winter are not excluded. In this case, naturally, they cannot serve as a basis for the growth of vein ice, since it is assumed that the growth of the latter occurs at the expense of melt water during the spring.

An examination of the graphs in Figure 3 allows one also to reach certain conclusions concerning the influence of a neighbouring fracture on the depth of the fracture under consideration. A comparison of the curves with  $\lambda = 0$  (single fractures) and  $\lambda = 0.4$  (neighbouring fracture located at a distance of  $2.5 \mu_1 h$ ) shows that neighbouring fractures have a lesser depth than single fractures. This means that, for example, if there initially existed a single (primary) fracture and later there appeared a neighbouring secondary fracture, then the primary fracture partially closes up.

Calculation of the opening profile of frost fractures.

On the basis of the above considerations we will present the results of calculations based on equation (6) in the form of expressions for determining the profile of the fractures in the middle of winter:

$$\bar{S}(y) = \bar{S}_c^t(\mu_1 h, y/h) - \frac{1}{\bar{\sigma}} (\mu_1 h)^2 \bar{S}^Y(\lambda, y/h) \quad (25)$$

and at the end of winter - beginning of spring

$$\bar{S}(y) = \bar{S}_k^t(\mu_1 h, y/h) - \frac{1}{\bar{\sigma}} (\mu_1 h)^2 \bar{S}^Y(\lambda, y/h), \quad (26)$$

$$\bar{S}(y) = \frac{\mu_1 S(y) E_{L-z}^p}{4(1-\nu^2) \sigma_{L-z}^p(t_{01})}, \quad (27)$$

where  $\bar{S}$ ,  $S$  - dimensionless and actual value of the opening of the fracture at depth  $y$ ;  $\bar{\sigma}$  - dimensionless stress according to equation (23).

The values of functions  $\bar{S}_c^t$ ,  $\bar{S}_k^t$  and  $\bar{S}^Y$  are presented in Tables III and IV. In Table IV the last line ( $\lambda = 0$ ) corresponds to a single fracture.

TABLE III

$\mu_1 h$	$y/h$					
	0	0,2	0,3	0,5	0,7	1,0
Function $\bar{S}_c^t$						
1,0	0,92	0,75	0,67	0,53	0,37	0
2,0	1,62	0,95	0,80	0,57	0,31	0
3,0	1,38	0,97	0,80	0,50	0,20	0
Function $\bar{S}_k^t$						
0,5	0,04	0,04	0,04	0,04	0,03	0
1,0	0,12	0,12	0,11	0,11	0,09	0
2,0	0,28	0,27	0,25	0,23	0,20	0
3,0	0,37	0,38	0,28	0,27	0,24	0

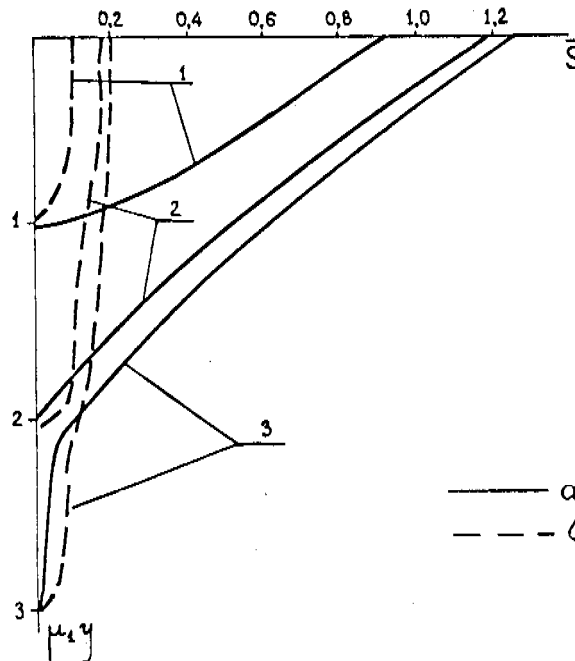

TABLE IV

$\lambda$	$y/h$					
	0	0,2	0,3	0,5	0,7	1,0
	Function $S^y$					
0,40	0,26	0,29	0,30	0,32	0,31	0
0,35	0,29	0,32	0,33	0,34	0,32	0
0,25	0,35	0,37	0,38	0,39	0,36	0
0,15	0,40	0,41	0,42	0,42	0,39	0
0,10	0,43	0,43	0,44	0,44	0,40	0
0,07	0,43	0,44	0,44	0,44	0,41	0
0,05	0,44	0,44	0,45	0,45	0,41	0
0,00	0,44	0,45	0,45	0,45	0,41	0

As an example in Figure 4 there are presented the profiles of single ( $\lambda = 0$ ) fractures, calculated on the basis of equations (25) and (26) with  $\bar{\sigma} = 20$ . As is evident from this Figure, at the end of the winter the width of the opening of the fractures on the surface is 6 - 9 times less than during the middle of the winter.

Figure 4



Calculated profiles of opening  $S$  of single frost fractures at  $\bar{\sigma} = 20$  and various depths  $\mu_1 h$ :  
 1 - with  $\mu_1 h = 1$ ; 2 - with  $\mu_1 h = 2$ ; 3 - with  $\mu_1 h = 3$ ;  
 a - in the middle of winter; b - at the end of winter.

Also of interest is the fact that during the middle of the winter the fractures have clear-cut wedge-shaped out-lines, while at the end of the winter the width of the fractures changes little with depth, which is in accordance with the actual observations presented in the study by Mackay (1974). With fractures of great depth (for  $\mu_1 h > 1.5$ ) their terminal zones are drastically narrowed, which is explained by the increasing effect with depth of the intrinsic weight of the soil itself.

Calculation of the equilibrium distance between neighbouring fractures (width of fracture polygons).

The formation of a second fracture, neighbouring a first fracture, obviously depends on the size of the temperature stresses in the vicinity of the first fracture. The character of the change of the temperature stresses in the vicinity of the fractures is shown schematically in Figure 1. As follows from this figure and equation (7) the temperature stresses caused by a smooth winter decrease in the surface temperature (long-period temperature oscillations) increase with increasing distance from a single fracture, asymptotically approaching the limit of the long-term tensile strength at a temperature equal to  $t_{01}$ . In this case one may explain the appearance of a second fracture at a finite distance from the first fracture by two causes: 1) the static non-homogeneity of the properties of the soil - fluctuation in the tensile strength (Lachenbruch, 1962), and 2) secondary short-period temperature fluctuations, creating additional stresses in excess of the limit of the long-term strength (Grechishchev, 1975). The second cause seems to us to be better substantiated, since in the case of very slow changes in temperature in a block of soil there should occur a redistribution of the stresses in such a way that at any point within the block these stresses do not exceed the limit of the long-term strength.

Taking into consideration that which has been presented above, for the determination of the distance between neighbouring fractures we will assume the following condition of strength:

$$(\sigma_x)_I + (\sigma_x)_{II} = \sigma_{L\pm}^p(t_{01}), \quad (28)$$

where  $(\sigma_x)_I$  - stresses caused by long-period changes in the temperature of the soil surface with an amplitude of  $t_{01}$ ;  $(\sigma_x)_{II}$  - additional stresses caused by short-period changes in the temperature of the soil surface with an amplitude of  $t_{02}$  and frequency  $\omega_2$ .

We may note immediately that in equation (28) there is not included the component of the stresses from the intrinsic weight of the soil, since this is substantially smaller than the thermal components.

Substituting in expression (28) the values of the included components according to equations (7), (17) and (15), and carrying out a numerical integration, we obtain:

$$\sigma_{L,t}^p(t_{01}) \bar{\sigma}^t(\mu_1 h; \mu_1 l) + \sigma_{II} \bar{\sigma}^t(\mu_2 h; \mu_2 l) = \sigma_{L,t}^p(t_{01}), \quad (29)$$

where  $\sigma_{II}$  - amplitude of additional stresses,

$$\sigma_{II} = \frac{\alpha_\infty(t_{01}) E_{L,t}^p(t_{01}) t_{02}}{(1-\nu) \sqrt{1 + \omega_2^2 r_p^2}}, \quad (30)$$

$r_p$  - time of relaxation with stretching of the frozen soil;  
 $\bar{\sigma}^t$  - function, determined according to Table V;  $\mu_2 = \sqrt{\omega_2 / 2a_M}$ .

TABLE V

$\mu_1 h$	$\mu_1 l$							
	0	0,63	1,0	2,0	3,0	4,0	5,0	10,0
$\bar{\sigma}^t$ in the centre of a polygon								
0,5	0	0,20	0,62	0,79	0,87	0,92	0,97	1,0
1,0	0	0,04	0,08	0,74	0,81	0,87	0,92	1,0
2,0	0	~0	~0	0,12	0,83	0,91	0,94	1,0
3,0	0	~0	~0	0,03	0,15	0,93	0,98	1,0
$\bar{\sigma}^t$ for a single fracture								
1,0	0	0,06	0,18	0,85	0,90	0,92	0,96	1,0
2,0	0	0,03	0,05	0,26	0,90	0,95	0,97	1,0
3,0	0	0,01	0,03	0,10	0,44	0,96	0,98	1,0

The values of  $\mu_2$  are 6 - 8 times larger than  $\mu_1$ . Therefore  $\mu_1 h \approx 6$  to  $8 \mu_1 l$  and  $\mu_2 l \approx 6$  to  $8 \mu_1 l$ . Since in practical calculations there are observed the conditions  $\mu_1 h \geq 1$ , and  $\mu_1 l \geq 1$ , then according to Table V it may be assumed that

$$\bar{\sigma}^t(\mu_2 h, \mu_2 l) \approx 1. \quad (31)$$

If, in addition, one takes into consideration condition (17) together with expression (30), then equation (29) may be given the following form:

$$\bar{\sigma}^t(\mu_1 h, \mu_1 l) = 1 - f, \quad (32)$$

where

$$f = t_{02}/t_{01} \sqrt{1 + \omega_2^2 r_p^2}.$$

Graphs of the relative temperature stresses  $\bar{\sigma}^t$  are presented in Figure 5. From an examination of these graphs and condition (32), for example, it follows that with  $f = 0.1$  alongside a single fracture with a depth of  $\mu_1 h = 1.0$  there may be formed a neighbouring fracture at a distance not closer than  $\mu_1 l \approx 3.0$ . This will be the minimal equilibrium distance between fractures. Moreover, after the formation of the neighbouring fracture the stress in the center of the polygon, between the fractures, falls to the value  $\bar{\sigma}^t \approx 0.64$  (in Figure 5 the curve  $\mu_1 h = 1$  for two fractures at  $\mu_1 l = 1.5$ ). For these same conditions it is possible to estimate the maximum width of an equilibrium polygon, since only those polygons will be stable for which the stresses between the fractures,  $\bar{\sigma}^t$  according to condition (32), will be smaller than  $1 - f = 0.9$ . Otherwise, the stresses after the formation of the second fracture still remain high and there will occur the formation of one more fracture, between the first two. In the given case such a maximum equilibrium distance between the fractures is  $\mu_1(21) = 10$ , since the stresses in the centre of such a polygon (with  $\mu_1 l = 5$ ) are somewhat smaller than 0.9. Thus the graphs in Figure 5 allow one to establish the minimum and maximum width of equilibrium polygons. For

the specific conditions  $\mu_1 h = 1$  and  $f = 0.1$  these values comprise  $(\mu_1 2l)_{\min} = 3$  and  $(\mu_1 2l)_{\max} = 10$ .

Figure 5

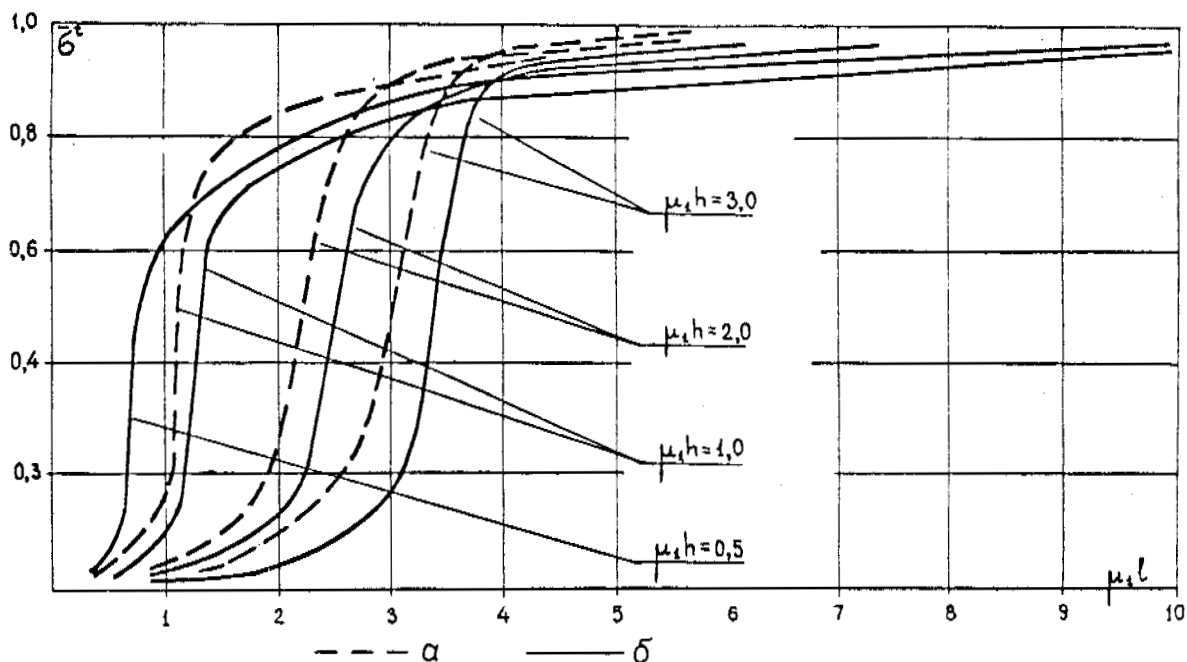

Stresses  $\bar{\sigma}^t = \sigma_x / \sigma_1^p(t_{01})$  at the surface of the soil  
 at distance  $l$  from a fracture of depth  $h$ :  
 a - for a single fracture;  
 b - in the presence of a neighbouring fracture at a distance  
 of  $2l$  from the first fracture.

An examination of the graphs in Figure 5 and a consideration of the circumstance that under natural conditions the value of  $f$  in equation (32) ranges from 0.07 to 0.18 allows one to reach the more general conclusion that in undisturbed conditions the width of the polygons, evidently, may range approximately within the limits of  $2 < \mu_1 2l < 12$ , i.e., from 6 to 40 m (with  $\mu_1 \approx 0.35$  1/m). Therefore the descriptions, encountered in the literature, of polygons up to 100 m in width (see, for example, Lachenbruch, 1962) force us to propose that in the center of such polygons there also existed frost fractures which, for some reason or other, were not manifested in the local stress relief.

In conclusion we may note that the proposed method of calculation of the parameters of frost fractures permits the resolution of several other interesting questions. In particular, this concerns the determination of the conditions necessary for the formation of second generation fractures.

#### REFERENCES

- BARENBLATT G.I. O ravnovesnykh treshchinakh, obrazuyushchikhsya pri khrupkoi razrushenii. (Equilibrium fractures formed by brittle rupture), - "Doklady AN SSSR" (Report of the Academy of Sciences of the U.S.S.R.), Vol. 127, No. 1, pp. 47-50, 1959.
- GRECHISHCHEV S.E. K raschetu glubiny kriogennykh treshchin i razmerov poligonov rastreskivaniya v gruntakh. (A contribution to the calculation of the depth of frost fractures and of the dimensions of the fracture polygons in soils). In the book: Geokriologicheskie issledovaniya (Geocryological studies). Trudy VSEGINGEO - Transactions of the All-Union Scientific Research Institute of Hydrogeology and Engineering Geology, No. 87, Moscow, pp. 4-13, 1975.
- GRECHISHCHEV S.E. K osnovam metodiki prognoza temperaturnykh napryazhenii i deformatsii v merzlykh gruntakh. (A contribution to the method for the prediction of temperature stresses and deformation in frozen soils). Moscow, VSEGINGEO, 53 pages, 1971.
- KARPENKO L.N. O metode rascheta napryazhennogo sostoyaniya v okrestnosti neglubokoi vyrabotki, proidennoi po vertikal'nomu ugol'nomu plastu. (A method for the calculation of the stress state in the vicinity of a shallow working, traversed along a vertical coal seam). Fiz.-tekhn. problemy razrabotki poleznykh iskopaemykh (Physical and technical problems in the development of useful minerals), No. 4, Publ. "Nauka", pp. 3-9, 1965.
- MUSKHELISHVILI N.I. Nekotorye osnovnye zadachi matematicheskoi teorii uprugosti. (Some fundamental questions of the mathematical theory of elasticity). Moscow, Publ. "Nauka", 706 pages, 1966.
- PANASYUK V.V. Predel'noe ravnovesie khrupkikh tel s treshchinami. (Limiting equilibrium of brittle bodies with fractures). Kiev, Publ. "Nauk. dumka", 382 pages, 1968.
- Razrushenie (Rupture). Volume 2. Matematicheskie osnovy teorii razrusheniya. (Mathematical principles of the theory of rupture). Editor G. Libovits, Moscow Publ. "Mir", 763 pages, 1975.

- SAVRUK M.P. Napryazheniya okolo treshchiny v uprugoi poluploskosti. (Stresses around fractures in an elastic half-space). - Fiz.-khim. mekhanika materialov (Physico-chemical mechanics of materials), 11, No. 5, pp. 59-64, 1975.
- CHEREPANOV G.P. Mekhanika khrupkogo razrusheniya. (Mechanics of brittle rupture). Moscow, Publ. "Nauka", 640 pages, 1974.
- MACKAY J. Ross Ice-wedge cracks, Garry Island, Northwest Territories. - Canadian Journal of Earth Sciences, Vol. 11, No. 10, pp. 1366-1383, 1974.
- LACHENBRUCH A.H. Mechanics of thermal contraction cracks and ice-wedge polygons in permafrost. New York, 69 pages, 1962.

## MINERAL STABILITY IN THE ZONE OF CRYOLITHOGENESIS

V.N. Konishchev

Moscow State University, U.S.S.R.

The essential rock forming character of cryogenic erosion is studied mainly in relation to particle size distribution. The stability of particles of coarse aleuritic size (0.05 - 0.01 mm) and the instability of both larger and smaller granulometric elements when related to factors of cryoeluvogenesis, lead to a number of fundamental geological and paleogeographic conclusions. In the opinion of many investigators, this particular aspect of supergenesis, in the conditions of the cryosphere, is an underlying cause of the formation of the loess deposits that are so widely found in permafrost regions and Pleistocene periglacial areas.

Another position bases itself on the very real possibility of aleuritic deposits with similar granulometric parameters being formed in the course of the sedimentogenic differentiation of mineral substance in both aqueous and atmospheric media.

The problem is further complicated when, applying the principles of the theory of lithogenesis to the sedimentary deposits formed in the course of redeposition, we are forced to recognize the existence of both cryogenic (inherited from the erosion stages) and sedimentogenic characteristics in their make-up.

Thus the currently accepted lithological criteria for products of the cryogenic transformation of different types of rocks are reduced to granulometric indications that are of an equivocal character and open to various interpretations as far as their origins are concerned.



Hence the present need to develop more definite criteria which, it may be hoped, will enable us to identify the cryogenic eluvium of fine-grained rocks and the products of its redeposition, and to distinguish these from sedimentary rocks of similar granulometric composition, but which are laid down under different climatic conditions at the various stages of lithogenesis, conditions that do not involve any cryogenic factors. At this point, obviously, it is expedient to consider another important lithological characteristic of sedimentary formations, namely their mineral constitution.

Analysis of the mineral compositions of formations which can almost certainly be regarded as either true cryogenic eluvium or as the products of its direct redeposition (e.g., the loess-like mantle formations of the Bol'shezemel'skaya tundra of Northwestern Siberia) shows that their most characteristic constituent, i.e., the coarse aleurite fraction, is made up principally of primary mineral debris, testifying to the leading role played by the fine grinding of various types of primary minerals in their formation. Secondary aleuritic particles in cryogenic eluvium play a subordinate role.

In order to determine the main mechanisms involved in the disintegration of various minerals as a result of cryogenic disintegration factors we must find answers to the following questions: (1) do all minerals have the same crushing limit; (2) what determines the actual crushing limit of a given mineral and to what extent is it connected with the specific structure of the mineral and the nature of the external effects of the cryogenic erosion factors; (3) how must one explain the fact that, notwithstanding the existence of a fragmentation limit of primary minerals considerably exceeding the size of the argillaceous minerals, the latter are subject to a powerful effect in the course of cryogenic erosion (Konishchev et al., 1974).

As we know, the phase transformations between water and ice in fine-grained subsoils take place in the negative temperature range, owing to the inhomogeneity with respect to energy and structure of the water contained in them.

The published formulae regarding the unfrozen water contents of various types of fine-grained rocks as a function of the temperature (Nersesova, 1958) are widely known. It has been shown experimentally, that the more strongly groundwater is subjected to the influence of mineral particle surfaces or of dissolved ions, the lower the temperature at which it crystallizes. A certain amount of bound water does not turn into ice at all, but remains in the unfrozen state. It may therefore be assumed that during crystallization of groundwater individual mineral particles of the subsoil system contain adsorbed bound water which surrounds them on their surfaces and the thickness of which decreases as the temperature changes. It is important to emphasize that however low the temperature, a distinct layer of unfrozen bound water remains around individual particles of the subsoil mass. The film of unfrozen water remains not only on the surfaces of argillaceous and other very fine-grained mineral particles, but also on those of the coarser aleuritic and arenaceous ones.

The main elementary processes involved in the disintegration of minerals during the freeze-thaw cycle are as follows:

- 1) the expansion pressure of ice resulting from the freezing of water in relatively large cracks in rocks and minerals;
- 2) closely associated with this process, the cryohydrogenic disintegration of grains, which is caused by the repeated fluctuation of expansion pressures from thin films of water in the microfissures of minerals owing to their hydration-dehydration in the course of ice formation in comparatively large pores and fissures of the subsoil;
- 3) temperature fluctuations which result in volume-gradient stresses that are intensified owing to the heterogeneous structure of the fragments and grains;
- 4) the pressure of the coating of ice on the mineral particles arising because of the more intense temperature compression of ice compared with rocks and minerals as the temperature

of the frozen subsoil decreases (Konishchev, 1973; Mazurov, Tokhonova, 1964).

The effects of these factors on the individual particles are exerted indirectly, through the layer of unfrozen water bound to the surfaces of the particles. Hence the character of the disintegration of mineral grains depends not only, but also on the thickness and properties of the layer of unfrozen water. Here we must regard the particle and the layer of adsorbed unfrozen water surrounding it more or less as a unit.

As far as the processes of particle disintegration in the course of cryogenic erosion are concerned, all the water contained in the subsoil can be divided into two categories which have contrary effects on the stability of the particles, namely the stable layer of unfrozen water and the thermally active water.

Under actual given conditions, the stable bound layer does not freeze. This determines its different thickness under different conditions. At very low temperatures the stable layer of water corresponds to a layer of strongly bound water, as identified by E.M. Sergeev et al., (1971), to a layer of adsorbed water (Lomtadze, 1972) and to a boundary phase of water (Tyutyunov, 1961).

Under conditions characterized by higher temperature values the stable layer can include some of the loosely bound layer of water (Sergeev et al., 1971) or the near boundary phase (Tyutyunov, 1961). Such properties of the strongly bound water that appears to constitute a large part of the stable layer as greater density, viscosity, elasticity and considerable shearing strength, enhance the stability of the particles in the presence of various external effects.

The reinforcement of frozen subsoils with thin films of adsorbed, unfrozen water is a factor which, at sufficiently low temperatures, increases their strength (Tyutyunov, 1973; Savel'ev, 1975).

The thermally active water is the main disintegrating agent. From the standpoint of its disintegrating action it may be divided into two kinds,

namely free water and the layer of metastable water to which the surface layers of bound water belong. The layer of metastable water is generally similar in its properties to loosely bound water (Sergeev et al., 1971). The main characteristic of the thermally active water is its mobility, i.e., its ability to migrate in the course of the freezing and thawing of the subsoil and in the course of phase transformations into ice. Depending on the course and speed of the process, the thermally active water affects the mineral skeleton differently. During the freezing of subsoils thermally active water undergoing transformation to the solid state produces expansion pressures in comparatively large particle fissures.

In contrast to the free water, the water of the metastable layer is characterized by high viscosity and a high modulus of elasticity. These properties, combined with its mobility in the freezing and thawing cycle, result in the cryohydrogenic disintegration of subsoil particles. During the freezing stage metastable water present in the microfissures of the particles emerges from them, moves into the inter-particle pores of the subsoil towards growing crystals of ice, thereby somewhat reducing the expansion pressure of the films of water in the microfissures. During the thawing stage, because of the melting of the ice in microfissures whose width exceeds twice the thickness of the stable layer of water, the former thickness of adsorbed water is restored. This once more increases the expansion pressures of the films of water in the microfissures, which reach maximum values at  $0^{\circ}\text{C}$ , when the film of adsorbed water is thin. The fluctuation of the expansion pressure in the microfissures resulting from the migration of the metastable layers of bound water also promotes disintegration of the particles.

The disintegration of mineral particles reaches its limit when the thickness of the stable layer of water becomes commensurate with the dimensions of the structural cracks and defects that mar the surface structure of the layer of particles (Figure 1). From this we draw an important conclusion, namely that the crushing limit of minerals is a direct function of the thickness and protective properties of the stable layer of water (Figure 2).

The magnitude and the strength properties of the stable layer are determined firstly by the surface properties of the mineral particles, and

Figure 1

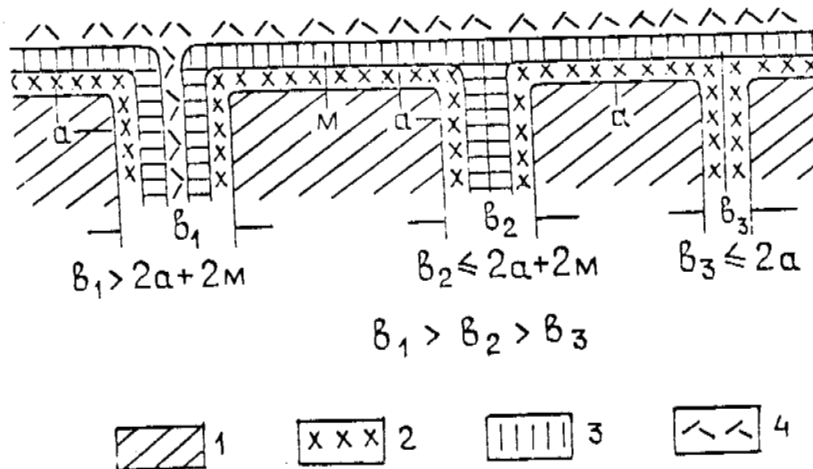

Manifestation of the factors of cryogenic disintegration in fissures of different size.

1 - mineral; 2 - stable layer of water (a); 3 - metastable layer of water (M); 4 - free water.

$b_1$  - large fissures in which wedging effects of ice and water occur;

$b_2$  - microfissures in which there are fluctuating wedge pressures from films of bound water;

$b_3$  - ultramicrofissures in which there are no wedging effects of ice nor fluctuating wedge pressures from films of water.

secondly by the properties of the groundwater solution (pH value, quantities and kinds of dissolved substances). The surface properties of the mineral particles, which determine the sorption capacity, are expressed in their specific surface energy. The latter is determined primarily by the crystallochemical structure of the surfaces of the different minerals, and also, in the opinion of a number of investigators, by their fineness of grain.

A very reliable way of estimating the magnitude of the stable layer in different minerals is to employ the data on their maximum hygroscopicity. According to the figures of E.M. Sergeev et al., (1971), the maximum hygroscopicities of particles smaller than 0.001 mm are 0.9% for quartz, 8 - 17% for feldspars (albite, microcline, orthoclase) and 36 - 48% for micas (muscovite, biotite).

Figure 2

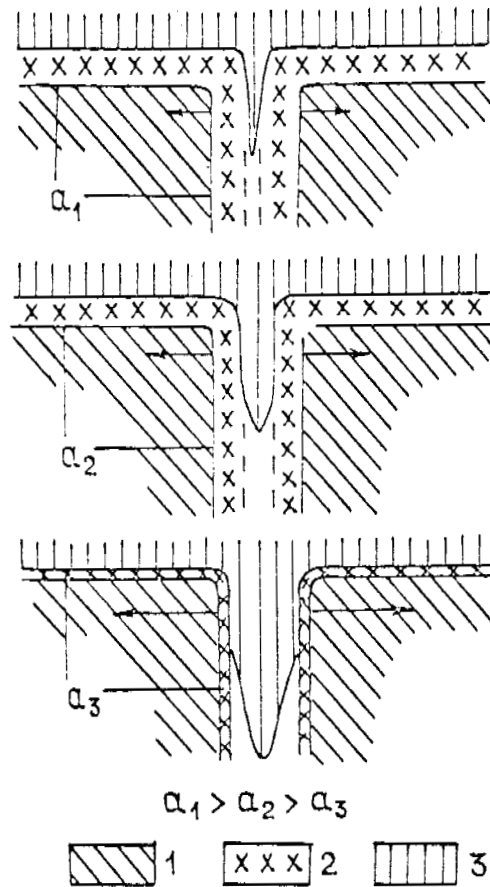

Wedging action of ice in a crack at different thicknesses of the stable layer of water (arrow lengths correspond to wedge pressures of ice).  
1 - mineral; 2 - stable layer of water (a); 3 - ice.

If the ratios of adsorption capacities of these minerals also hold for larger particles, it may be concluded that the thickness of the stable layer of water in a polymineral mass in the process of freezing will be a maximum for the micas, smaller for the feldspars and a minimum for the quartz.

Available figures on the free surface energy of muscovite crystals (4.5 joules/m<sup>2</sup>) and quartz crystals (0.5 joules/m<sup>2</sup>) (Pol', 1971) confirm this relationship. Thus, if we accept the given ratios, the crushing limit for quartz mineral grains will be the highest, that for micas the lowest, while that for feldspar grains will occupy an intermediate position. A more accurate idea of the values of the stable layer can be obtained by analysing

the curves of unfrozen water in subsoils of various mineralogical composition. However, the majority of published curves of unfrozen water content as a function of the temperature describe the phase state of the water in absolute weight units relative to the weight of the dry mineral part of the subsoil, and therefore cannot give an accurate representation of the influence of the skeletal surface energy on the unfrozen water content.

A recalculation of the unfrozen water content, not per unit weight of subsoil, but per total surface area, which was carried out elsewhere (Anderson, Tice, 1972; Anderson, Morgenstern, 1973), enables us to estimate the magnitude of the stable layer of water at various temperatures for various types of subsoils and minerals. From an analysis of these curves it may be concluded that the specific surface energies in primary minerals is higher than in certain clays.

Among the latter, kaolinite has a stable larger layer of water than bentonite. Confirmation of this is obtained from a study of the NMR spectra of the adsorbed water protons in montmorillonite and kaolinite. According to the figures of A.A. Ananyan et al., (1973), for approximately the same quantity of adsorbed layers of water the transverse relaxation time  $T_s$  is shorter than would correspond to Ts.M. Raitburd and M.V. Slonimskii's (1968) conclusion concerning the strong bonding of adsorbed water in kaolinite. According to R.I. Zlochevskii's figures (1969), the surface conductivity of montmorillonite is 4 - 5 times greater than that of kaolinite. From all this it may be concluded that the specific free surface energy of kaolinite is greater than that of montmorillonite, although the absolute quantity of unfrozen water in montmorillonite clays is always greater owing to the greater fineness of their grain. Hydromicas, of course, occupy an intermediate position.

Very important for an understanding of the whole mechanism of cryogenic erosion is the assumption that the specific surface energy (SSE), which determines the thickness and properties of the stable layer of water, depends on the fineness of grain. This assumption is based on a number of publications by V.F. Kiselev and his co-workers. From studies of the character of the dehydration and the adsorption capacity of very fine-grained

quartz soils (particle sizes from 960 to 3.8 mm) it was established that the water content per unit surface area decreased with increasing fineness. One of the reasons for this relationship is associated with the packing of SiO<sub>2</sub> tetrahedrons on the surfaces of small quartz particles owing to the amorphization of their surface layers. However, the parabolic character of the SSE curves as a function of the fineness, as indicated by V.F. Kiselev's investigations, can be considered applicable only to the very fine-grained part of the granulometric spectrum of quartz particles.

When the less fine-grained part of the spectrum is taken into consideration the relationship becomes more complex.

One of the methods of studying bound water in fine-grained systems is to investigate the electrokinetic characteristics, especially the charges on subsoil particles. The formation of an electric charge on the surface of a mineral particle depends on its crystallochemical structure and on the composition and properties of the medium interacting with it. It follows from this that the charges on subsoil particles are an index of their surface energy.

TABLE

Variation of the charges on mineral particles as a function of fineness (Savel'ev 1971)

Charges on studied minerals ( $Q \cdot 10^{-11} \text{ cm}^{-2}$ )	Fraction, mm	Fineness						
		1-0.5	0.5-0.25	0.25-0.1	0.1-0.05	0.05-0.01	0.01-0.005	0.005-0.003
Quartz		-0,372	-2,172	-2,590	-4,342	-4,632	-1,014	-0,220
Microcline		0,302	4,020	12,903	2,713	1,974	1,621	-
Calcite		4,493	5,182	11,875	6,292	1,481	0,509	-
Gypsum		7,858	11,524	20,533	14,666	-	-	-
Hornblende		-0,135	-0,549	-1,543	-3,968	-24,397	-0,617	-
Muscovite		79,030	134,275	89,521	42,273	0,527	-	0,246
Biotite		0	-4,481	-20,316	-25,250	-10,013	-1,088	-0,178

The structural-sorptional differences of minerals of different fineness of grain are well illustrated by a table taken from the work of B.A. Savel'ev (1971) in which the data of E.M. Sergeev and his co-workers are cited. It is clear from the table that the maximum charge corresponds to a



certain fineness of grain. In the case of quartz, the main rock-forming mineral of sedimentary rocks, the charge density is a maximum for the fraction 0.05 - 0.01 mm. The higher the charge of the mineral, the coarser the fraction that carries the maximum charge.

The table in question pertains to the air-dry state of the mineral particles. It can be assumed, however, that the principal relationships between the charge values, and hence also between the SSE's of different minerals and of particles of different fineness, will continue to hold when they are interacting with water. The values in the table do not conflict, for example, with the above cited maximum hygroscopicities of the respective minerals.

Using the existing relationships of the SSE to mineral composition and fineness, as stated above, firstly an explanation is found for the already known characteristics of cryogenic erosion. Secondly, it becomes possible to propose, in general outlines, a theoretical model of the minerological composition of the cryogenic eluvium, showing, in particular, how the commoner individual minerals are distributed over the granulometric spectrum

The most general mechanism, obviously, is the accumulation, in the course of cryogenic crushing, of mineral particles with maximum SSE as the particles most resistant to the cryogenic erosion factors.

Let us introduce as a critical size (CS), the particle size of a given mineral which has maximum SSE. For quartz the CS is equivalent to the size range of the coarse aleurite fraction (0.05 - 0.01 mm). Particles of this size are very stable, since the correlation of the dimensions of microfissures and defects of various kinds and the thickness of the stable layer of water prevent the occurrence of any splitting action by ice or thin films or water.

Quartz particles whose dimensions exceed the critical must be ground up intensively in the course of their regular freezing and thawing in the wet state. This is due, on the one hand, to a lower SSE, and, on the

other, to an increase in the size of fissures. The crushing has a limit, which for quartz is determined by the critical size of the particles, corresponding to the size of coarse aleurite (0.05 - 0.01 mm). It is precisely this circumstance which explains the prevalence of particles of the coarse powdery fraction in cryogenic eluvium, since quartz is the commonest mineral in sedimentary rocks and the products of their cryogenic transformation.

Quartz particles smaller than the CS are characterized by low SSE values and this, it would appear, must lead to their intensive crushing. Evidently, however, this does not occur, for along with a reduction of the SSE in the small particles there is also a reduction in the size of the microfissures and defects and this, of course, limits the possibility of their disintegration, without, however, preventing it entirely. Lowering of the SSE of the small particles causes their aggregation in the course of freezing. Thus the granulometric spectrum of quartz relative to the factors of cryogenic erosion is divided into three parts: 1) particles larger than the CS - unstable; 2) particles of CS - very stable; 3) particles below CS - comparatively stable and tending to form aggregates.

For other minerals, obviously, the same regularities must be observed, except, of course, for the critical size of the particles. For feldspars, judging from the figures, the CS is larger than that of quartz, while for stratified silicates (biotite, muscovite, chlorite) it is larger still. The CS's of amphiboles and pyroxenes are the same as that of quartz. If we postulate an initial mixture comprising particles of quartz, feldspars, amphiboles, pyroxenes and micas whose dimensions exceed the corresponding CS values, then theoretically, under the action of the cryogenic erosion factors, a transformation of the mixture must occur whose granulometric spectrum is determined by the maximum contents of the separate minerals in the given granulometric fractions, corresponding to their maximum SSE. Thus the coarse aleurite fraction must be characterized by a maximum content of quartz, amphiboles and pyroxenes; the maximum content of feldspars must be observed in the coarser fine-sand and small arenaceous fractions. The maximum mica content will be found in a still coarser granulometric fraction.

Under natural conditions rocks of different fineness (sands, boulder clays, etc.) are found in the region of cryogenic erosion, and in these the minerals are distributed over the granulometric spectrum in other ratios and their values may be very different relative to the critical size. Under the action of cryogenic erosion the original mineralogical spectrum must change in accordance with the mechanisms described above. This imposes special requirements with respect to the methodology of studying the mineralogical composition of the cryogenic eluvium and the primary rocks. These requirements consist in the necessity of studying the distribution of individual rock-forming minerals on the basis of narrow granulometric fractions within the limits of the entire granulometric spectrum of both the primary and the secondary rocks.

Some of the above considerations concerning the behaviour of a number of minerals in the course of cryogenic erosion have been confirmed experimentally. A study of the changes in granulometric composition of various minerals after fifty cycles of freezing ( $-20^{\circ}\text{C}$ ) and thawing ( $+30^{\circ}\text{C}$ ) has shown that particles of quartz, hornblende and diopside 0.05 - 0.1 mm in size experience marked disintegration, the intensity of which increases with increasing moisture levels. This suggests that the critical size of these minerals lies in the smaller fraction. On the other hand the granulometric composition of a primary specimen of albite made up of grains of the same dimensions remained practically unaltered, evidently because this size of albite grain corresponds to the critical size. The behaviour of micas and chlorite, i.e., minerals with high charges, is interesting. These minerals disintegrate with great intensity in the air-dry state. When they are saturated with water to the limit of fluidity there is practically no crushing of biotite and chlorite (0.05 - 0.1 mm grains) but muscovite decreases markedly in size. Very probably this is associated with the protection afforded by films of water. A detailed analysis of this experiment has been made in a special paper (Konitsev et al., 1976). The same experiment also established the disintegration of particles of various minerals whose sizes were smaller than the critical (electron-microscopic investigations).

In a work by G.P. Mazurov and E.S. Tikhonov (1964) the results of changes in the fineness of quartz and feldspar sands due to their repeated

freezing and thawing were given. On the basis of their figures, using an index of relative stability of particles\* we estimated the stability of quartz and feldspar grains 1 to 2 mm in size. Under otherwise identical conditions it was found to be greater for the grains of feldspar. That is to say, for coarse grains the ratio of surface energies of quartz and feldspar remains the same as for the finer ones. This determines the ratio of crushing intensities, which was higher for the quartz grains.

The ideal pattern of particle stability may be complicated by the presence of adsorbed substances, various kinds of films, etc. on their surfaces, altering the SSE. For example, the particles of quartz in primary rocks were often covered with films of iron hydroxide, aluminium, and organomineral compounds, and this can substantially affect the character and intensity of their crushing. The same applies to eroded and partially eroded grains of feldspars and other minerals.

The properties of the stable layer of the bound water also depend on the quantity and composition of the ions adsorbed on the surfaces of subsoil particles. The maximum hygroscopicity for example, depends on the valency of the cations adsorbed by the particle surface (Sergeev et al., 1971). The size of the stable layer of water, obviously, also increases with increasing valency of the adsorbed cations. Hence the resistance of the particles to the action of the cryogenic erosion factors corresponds to the series:

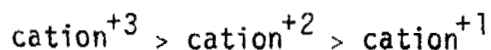

This rule is very well illustrated by the results of experiments on the freezing of quartz sands saturated with solutions of various salts (Poltev, 1966). The freezing stability of a quartz particle increases with increasing salt concentration in the pore solution; sand containing a  $\text{CaCl}_2$  solution is more resistant to freezing than one saturated with sodium salts ( $\text{NaCl}$ ,  $\text{Na}_2\text{SO}_4$ ). The effect of the pH of a subsoil solution on the character of the

---

\*  $H = \frac{a-b}{a \cdot n}$ , where H - index of relative stability of particles; a - quantity of size fraction in % before freezing; b - quantity of same fraction remaining after the freezing cycles; n - number of freezing and thawing cycles.

cryogenic disintegration of minerals has not been studied. Currently available data indicate that the value and sign of the electrostatically active centres on argillaceous mineral crystal fragments, and hence the properties of the bound water, depend on the pH value (Osipov, Sergeev, 1972).

In an acid medium the surfaces of the argillaceous particle fragments receive a positive charge, and in an alkaline medium they receive a negative one. The positive charge in an acid medium is higher for minerals of the kaolinite type than for minerals of the montmorillonite type. In an alkaline medium the difference is negligible. In the acid medium the total charge on argillaceous minerals is lower than in the alkaline medium. This agrees closely with the abrupt increase in viscosity of an argillaceous suspension on transition of the medium from acid to alkaline. This phenomenon is best expressed in kaolinite pastes (Osipov, Sergeev, 1972).

Since the magnitude of the particle charge is a factor involved in its resistance to cryogenic action, it may be assumed that as the pH of the medium decreases the stability of an argillaceous mineral in the presence of cryogenic erosion factors will also decrease. With respect to the primary minerals this assumption also appears very probable. However, the question calls for a special investigation.

The effect of external factors on cryogenic erosion can also be estimated on the basis of the ideas expressed above. Among the concrete factors leading to a given set of physical-geographic conditions, the principal ones are: the number of transitions through  $0^{\circ}\text{C}$ , the amplitude of the temperature fluctuations, the rate of freezing, the continuous duration of the frozen state and the number of temperature fluctuations in the negative range of values, characterized more or less by the mean annual temperature of the soil.

The effect of these factors on the nature and intensity of cryogenic disintegration is determined above all by their effect on the correlation of the stable and metastable layers of bound water and their dynamics in the freeze-thaw cycle. The number of transitions through  $0^{\circ}\text{C}$ ,

the main factor involved in cryogenic disintegration in the opinion of many investigators, cannot unequivocally account for the various aspects of the transformation of fine-grained subsoils. This follows from the well-known rule that the finer the subsoil, the broader will be the range of temperatures in which phase transformations of water are observed. Hence to appraise the intensity of the disintegration of fine-grained minerals a more accurate indicator would be the number of temperature fluctuations within the entire range of phase transitions of water. Since the phase transitions of the bound water take place in a negative range of temperatures, an important index of the intensity of cryogenic disintegration is the continuous duration of the frozen state of the rocks, characterized by their mean annual temperature. The extent of cooling of the rocks determines the magnitude of the stable layer of water which, as shown above, plays a protective role in the process of cryogenic disintegration. We know that the lower the temperature, the less unfrozen water there will be in fine-grained subsoils, and hence the thinner the stable layer of water. From this it follows that the intensity of fine-grain disintegration increases with increasing degree of cooling in the freeze-thaw cycle, as is partly confirmed by Tricart's experiments (1956), in which he simulated erosion under maritime and continental climatic conditions.

#### REFERENCES

- ANANYAN A.A., VOLKOVA E.V. and FEOKTISTOVA O.B. Otsenka zavisimosti vremen relaksatsii protonov vody v tonkodispersnykh gornykh porodakh ot vlazhnosti porody. (Estimate of the variation of relaxation time of water protons in very fine-grained rocks as a function of the wetness of the rock). In the book: Merzlotnye issledovaniya (Permafrost studies), No. 13, Izd-vo MGU, pp. 158-161, 1973.
- ZLOCHEVSKAYA G.I. Svyazannaya voda v glinistykh gruntakh. (Bound water in argillaceous subsoils), Izd-vo MGU, 174 pages, 1969.
- KISELEV V.F. Poverkhnostnye yavleniya v poluprovodnikakh i dielektrikakh. (Surface phenomena in semi-conductors and dielectrics), Moscow, "Nauka", 295 pages, 1970.
- KONISHCHEV B.N. Kriogennoe vyvetrivanie. (Cryogenic erosion). II International Conference on Permafrost. Reports and Communications, No. 3, Yakutsk, pp. 38-44, 1973.

- KONISHCHEV V.N., ROGOV V.V. and SHCHURINA G.N. Vliyanie kriogennykh protsessov na glinistyie mineraly. (Effect of cryogenic processes on argillaceous minerals). "Vestn. MGU, Ser. Geograf.", No. 4 pp. 40-46, 1974.
- LOMTADZE V.N., ROGOV V.V. and SHCHURINA G.N. Vliyanie kriogennykh faktorov na pervichnye mineraly (rezul'taty eksperimental'nykh issledovaniy). (Effect of cryogenic factors on primary minerals - results of experimental investigations). In the book: Problemy kriolitologii (Problems of cryolithology), No. 5, Izd-vo MGU, pp. 50-60, 1976.
- MAZUROV G.P. and TIKHONOVA E.S. Preobrazovanie sostava i svoystv gruntov pri mnogokratnom zamorazhivaniy. (Transformation of the composition and properties of subsoils in the course of recurrent freezing). - "Vestn. LGU", No. 18, Issue 13, Ser. Geol. i Geograf., pp. 35-44, 1964.
- NERSESOVA Z.A. Fazovyi sostav vody v gruntakh pri zamerzaniy i ottaivaniy. (Phase constitution of the water in subsoils during freezing and thawing). In the book: Materialy po laboratornym issledovaniyam merzlykh gruntov (Materials on laboratory studies of frozen subsoils), No. 1, Moscow, Izd-vo AN SSSR, pp. 31-35, 1958.
- OSIPOV V.I. and SERGEEV E.M. Kristallokhimiya glinistykh mineralov i ikh svoystva. (Crystal chemistry of argillaceous minerals and their properties). "Inzh.-geol. svoystva glinistykh porod i protsessov v nikh". Trudy Mezhdunar. simpoz., No. 1, Izd-vo MGU, pp. 151-153, 1972.
- POL' R.V. Mekhanika, akustika i uchenie o teplote. (Mechanics, acoustics and theory of heat). Per. s Nem. Moscow, "Nauka", 479 pages, 1971.
- POLTEV N.F. Izmenenie granulometricheskogo sostava peschanykh gruntov pri vozdeystvii na nikh rastvorov elektrolitov i protsessa zamerzaniya-ottaivaniya. (Change in the granulometric constitution of arenaceous subsoils when acted upon by electrolyte solutions and processes of freezing and thawing). In the book: Merzlotnye issledovaniya (Permafrost studies), No. 6, Izd-vo MGU, pp. 199-206, 1966.
- RAITBURD Ts.M. and SLONIMSKAYA M.V. Kristallokhimiya poverkhnosti glinistykh mineralov i mikrostruktura glin. (Crystal chemistry of the surface of argillaceous minerals and the microstructure of clays). In the book: Fizicheskie i khimicheskie protsessy i fatsii (Physical and chemical processes and facies). Moscow, "Nauka", pp. 42-50, 1968.
- SAVEL'EV B.A. Fizika, khimiya i stroenie prirodnykh l'dov i merzlykh gornykh porod. (Physics, chemistry and structure of native ice and frozen rocks). Izd-vo MGU, 506 pages, 1971.
- SAVEL'EV B.A. Fiziko-khimicheskie osnovy formirovaniya stroeniya, sostava i svoystv merzlykh gornykh porod. (Physical-chemical basis of the structure, composition and properties of frozen rocks). II International Conference on Permafrost, Reports and Communications, No. 8, Yakutsk, pp. 92-108, 1975.

- SERGEEV E.M., GOLODKOVSKAYA G.A. and ZIANGIROV R.S. et al., Gruntovedenie. (Soil science). Izd-vo MGU, 595 pages, 1971.
- TYUTYUNOV I.A. Vvedenie v teoriyu formirovaniya merzlykh porod. (Introduction to the theory of the formation of frozen rocks). Moscow, Izd-vo AN SSSR, 108 pages, 1961.
- TYUTYUNOV I.A. Novye predstavleniya o prirode prochnosti merzlykh gruntov. (New ideas on the nature of frozen soil strength). II International Conference on Permafrost, Reports and Communications, No. 4, Yakutsk, pp. 142-147, 1973.
- ANDERSON D.M. and TICE A.R. Predicting unfrozen water contents in frozen soils from surface area measurements. Highw. Res. Record No. 393. pp. 12-18, 1972.
- ANDERSON D.M. and MORGENSTERN .N.R. Physics, chemistry and mechanics of frozen ground: A review. II International Conference on Permafrost. National Academy of Sciences, Washington, D.C. pp. 257-288, 1973.
- TRICART I. Etude expérimental du problème de la gélivation. Bull. periglac. No. 3, pp. 41-45, 1956.





## PRINCIPLES OF CLASSIFICATION OF POLYGONAL-VEIN STRUCTURES

N.N. Romanovskii

Moscow State University, Department of Geology, U.S.S.R.

Polygonal-vein structures (PVS), which form as a result of the frost fracturing of the upper level of the ground, encompass numerous forms of soil (earth) veins, composed of materials of varying composition, ice veins (called wedge ice and polygonal wedge ice by different authors), ice-soil, soil-ice, and other types and varieties of veins. The dimensions of the polygonal lattice vary in plan, as does the morphology, and the height and width in cross section. There is much in the literature devoted to their description.

Polygonal-vein structures are very important in the evaluation of geocryological conditions in permafrost regions, in the permafrost facies analysis of Quaternary deposits, in paleogeographic reconstruction, etc. All of the above makes it necessary that they be systematized on a genetic basis, with mandatory consideration of the natural conditions under which they form, and of the processes occurring during their formation. In doing this it appears necessary to us that 1) the classification scheme be based on fundamental geological processes, separating them from secondary and associated processes, and 2) that the range of conditions under which the respective PVS categories form be established.

The study of modern structures which are currently in the process of development, and of old structures which have often been subjected to profound secondary changes, reveals that a number of forms which formed under different conditions are morphologically very similar. PVS develop in deposits of different origin and properties. These deposits constitute the

environment within which these structures are found. This environment is not inert; it acts upon the PVS, altering their morphology, dimensions, and composition. It often happens that structures which form under similar conditions acquire pronounced morphological differences in various types enclosing ground. For this reason, the external similarity or difference of veins cannot be used as the basis for their genetic classification.

The classification scheme proposed below for polygonal-vein-structures is based on the following principles:

1. All of the structures are subdivided into two main groups: primary and secondary. Primary structures form as the result of repeated frost fracturing, infilling of the cracks with mineral deposits or ice, and subsequent annual reconstitution of the material in the fractures. Secondary structures appear as the result of the degradation of primary structures when they thaw as a result of increased depth of the annual layer of thawing, and also as the result of degradation of permafrost.

2. Primary PVS are classified according to two main characteristics: firstly, on the basis of the position of the frost fractures in the seasonally frozen layer (SFL) or seasonally-thawing layer (STL) and permafrost system; secondly, according to the nature of the material with which the fractures are filled. Successive reconstitutions of the material filling the fractures are essentially predetermined by whether they lie within the SFL (STL) or whether they penetrate the permafrost. For this reason, the processes of transformation of the material in the fractures, which affect the morphology of the developing structures, are secondary (concomitant), although highly important. They are directly related to various deformations and other changes in the enclosing rocks, which are also concomitant.

3. Polygonal-vein structures form over a geologically long period of time, during the course of which the conditions of their formation do not remain unchanged. In some cases the conditions are such that the characteristic, distinctive traits of the vein structures change only quantitatively, while in other cases the changes are of a qualitative nature.

In the former case the position of the fractures in the STL-permafrost system, and the material filling the fractures, remain constant, with the result that certain categories of PVS are essentially basic. In the other case the position of the fractures in the STL-permafrost system changes with time. This occurs chiefly as the result of changes in the temperature regime of the rocks and the depth of the STL. In some years the frost fractures are located entirely within the STL, in others they penetrate into the permafrost. The depth of thaw periodically increases to such an extent that it reaches the maximum depth to which these fractures penetrate, which results in the melting of the material which fills the veins. As a result of this, there are formed primary structures of a transitional, intermediate character between the basic categories.

The manner in which the frost fractures fill up as the PVS develop remains the same in some cases while differing in others. Thus, when conditions are such that there is enough moisture at the surface of the earth during the period when the fractures are open ("gaping"), they fill up with water every year, forming veins of congelation ice as they freeze. The fractures do not fill up with ice when there is insufficient moisture at the surface. In the presence of eolian processes the cracks may be filled with air-dry eolian sand. But the surface moisture conditions may change periodically either as the result of changes in the climate or in the local facies conditions. In view of this, there may be periodic changes in the nature of the material which fills the fractures, and the resulting structure reflects these variations.

While the first principle on which the classification scheme for polygonal-vein structures is based may be considered to be generally accepted and quite well understood, the remaining two principles require explanation and substantiation.

Classification of PVS according to the position of the frost fractures in the STL (SFL)-permafrost system is determined by the fact that, in structures which are entirely within the STL (SFL), ground ice cannot accumulate. The ice which forms in the frost fractures melts every year. In structures (or, more precisely, in the lower parts of structures) which form

in permafrost below the STL, on the other hand, ground ice may accumulate and remain for many years. Such PVS categories as wedge ice are represented almost wholly by congelation ground ice. The author has shown in a number of papers (Romanovskii, 1970, 1973 and others) that the penetration of frost fractures from the STL into the permafrost depends on the mean annual temperature at the foot of the STL or in the layer of their annual temperature fluctuation  $-t_{\text{mean}}$ . These temperatures are the boundary between the structures which form entirely within the STL (SFL), and the two-level structures whose lower portion forms within the permafrost and may contain ground ice, and whose upper portion is located within the STL. The former may provisionally be called "high-temperature" inasmuch as they develop at higher  $t_{\text{mean}}$  values than the latter "low-temperature" structures. During such formation of low-temperature PVS with a decrease in  $t_{\text{mean}}$ , and with other conditions being equal, the thickness of the STL decreases and the depth of penetration of the fractures below the STL into the permafrost increases. As a result, there is a local decrease in the dimensions of the upper portion of the vein structures, and an increase in the lower portion. Thus, there is a natural temperature control over the penetration of frost fractures from the STL into the permafrost and over the development of the resulting vein structures. It must be noted that the temperature of the rock at which these qualitative structural changes occur varies for soils of different composition and ice content, i.e., there is a relationship between these temperatures, the lithological characteristics of the rocks, and their moisture content (permafrost-facies) (Romanovskii, 1972). This relationship is not taken into account in the classification of the polygonal-vein structures, but its existence should be borne in mind when carrying out geocryological research and when reestablishing paleological permafrost conditions for vein structures in rocks of various composition and origin.

Frost fractures which form in the fall and winter are filled mainly by the entry of 1) meltwater or floodwater, and 2) air-dry sand. In addition, a small amount of snow may fall into the fractures, sublimation ice crystals may accumulate, and the lower ends of the fractures may fill up as the result of the enclosing ground crumbling down from the walls.

Infilling of the fractures with water, which becomes veins of congelation ice upon freezing, occurs only in the spring, when there is

significant flooding of the surface. Wedge ice forms in permafrost when this process is repeated many times. In STL and SFL in summer these veins melt and the resulting cavities are partially or completely filled with mud or falling pieces of the enclosing ground. In weakened zones in the area of congelation ice veins there occur inwash of organic matter, weathering, undermining or infilling, etc. The repeated occurrence of these processes results in the formation of soil veins in the STL and SFL and, in cases when the fractures penetrate into the permafrost, in the formation of an upper layer of soil above the ice veins. In this way, when congelation ice forms in frost fractures, a temperature series of polygonal-vein structures is created. Under conditions of relatively high  $t_{\text{mean}}$  of the rocks in the STL and SFL (when the fractures do not extend beyond the confines of the layer) initial-soil veins form, and when the  $t_{\text{mean}}$  are low wedge ice forms. As indicated above, the latter are two-level structures, and as the temperature of the rocks drops (other conditions remaining equal) the vertical extent of the ice veins increases, while that of the soil portion within the STL decreases.

Within the range of ground temperatures at which frost fractures penetrate from the STL into permafrost there develop transitional polygonal-vein systems in which wedge ice forms in low-order generation fractures and initial-soil veins form in high-order generation fractures (Romanovskii, Boyarskii, 1966; Romanovskii, 1973). Transitional forms of vein structures develop under such conditions. During the coldest stages of the period of formation of these transitional structures they develop as thin wedge ice, extending vertically for up to several tens of centimeters. During these stages the thickness of the STL and the  $t_{\text{mean}}$  of the rocks exhibit the lowest values of the formation period. We note that the vertical dimensions of such ice veins are comparable to the thickness of the "transitional layer", although they usually slightly exceed it. According to V.K. Yanovskii (1933) and Yu.L. Shur (1975), the transitional layer is a layer of permafrost between the layer of deposits which thaw annually and the layer which is continuously frozen over a specific period (in this case, during the period of formation of the PVS). The upper surface of the transitional layer  $\Delta \xi_t$  coincides with the minimum, while the lower surface coincides with the maximum depth of thaw during this period.

During warmer or more continental stages, when the thickness of the STL increases, the rocks of the transitional layer thaw and the thin ice veins melt. Small pseudomorphs form in their place. Continuing frost fracturing and seasonal infilling of the fractures with congelation ice causes further vein structures in the STL to develop as initial-soil veins. They remain narrow in their lower portion but their width usually increases in their upper portion. A drop in the ground temperature and a decrease in the thickness of the STL can again result in the formation of small ice veins in the permafrost. As a result, such structures have a transitional nature not only between initial-soil veins and wedge ice, but also between pseudomorphs after them, i.e., between primary and secondary structures.

Infilling of fractures with air-dry sand occurs in regions where surface moisture is extremely low and in the presence of intense eolian processes. Under these conditions dry eolian sand and gravel fall into the frost fractures in winter. Eolian material either gets into the fractures directly, as though into traps, as it is carried over the surface by the wind, or it first accumulates in polygonal depressions and then penetrates into the fractures as they form. In the latter case sand-wedges form. These have been studied mainly in the Antarctic by the American researchers T. Péwé (1959) and T. Berg and R. Black (1966). Such veins develop under extremely severe climatic and geocryological conditions, forming a paragenetic permafrost-facies series with ice and sand-ice veins (composite wedge). There is no doubt that sand-wedges can also form under less severe geocryological circumstances, but the climate must be very dry, there must be little surface moisture, and there must be active eolian processes. Relicts of sand-wedges are widely found in the periglacial zone of the last glaciation in Europe and North America.

Under conditions when the infilling of frost fractures with sand alternates in time with infilling by congelation ice, transitional varieties form between sand-wedges on the one hand and initial-soil veins and wedge-ice on the other. Under these circumstances, when the  $t_{\text{mean}}$  of the rocks is low, sand-ice veins form. As mentioned above, these have been studied in the Antarctic. The ratio of sand to ice in these composite wedges fluctuates within a very large range, forming a practically continuous series from

wholly ice to wholly sand veins. As examples of high-temperature varieties of veins in the form of primary sand-ice veins, we examined the so-called "deflection veins" described in Central Yakutiya (Katasonova, 1972). They are associated with STL of low-moisture sandy eolian and alluvial deposits with temperatures near  $0^{\circ}\text{C}$ . Fossil veins of this type, sometimes having a sand-ice composite end section (transitional varieties from high-temperature to low-temperature), have been studied by N.S. Danilova (1963) in the alluvial deposits of high terraces along the Bilyuya River. Under present conditions neither veins filled with initial sand nor with initial sand-ice form a single continuous zonal permafrost series. Because of this many of their varieties have received very inadequate study, and certain others we are distinguishing on a trial basis. Surveys and additional research are required.

In the opinion of many authors, infilling of frost fractures with sublimation ice may be significant. Sometimes it may even be the deciding factor in the formation of wedge ice, which can be quite thick. These ideas are based on indirect data on the chemical composition and physical properties of this type of ice, and also on direct observation of crystals of sublimation ice in open cracks in winter and in incompletely closed fragments of fractures in ice vein bodies. We shall skip the indirect data and analyze the thermodynamic conditions of formation of sublimation ice in frost fractures.

V.N. Zaitsev's studies of the wedge ice of seacost lowlands in Yakutiya have shown that in winter, and during much of the spring, the conditions for the formation of sublimation ice in fractures by means of the inflow of water vapor from the outside are nonexistent. During these periods the temperature of the walls of the cracks is higher than that of the outside air, and the vapor pressure of the latter is insignificant. As the air seeps into the cracks the ice sublimates and the rock walls dry out. This has been confirmed by the direct observations of Sh.Sh. Gasanov, who established that on cold days steam forms over the cracks. In the spring, as the snow melts, the cracks become filled with congelation ice, and rare cracks which are not filled close up as the result of the expansion of the rocks as their temperature in the massif rises. The accumulation of sublimation ice in



frost fractures as the result of the exchange of air with the atmosphere is possible only during a brief time period, in the spring, before the snow starts to melt. But even during this period the conditions for the active formation of sublimation ice are not very favorable inasmuch as the external air has a higher temperature and a lower density than the air in the cracks. As a result of this there is no density convection of the air. Thus, there is an annual decrease in the amount of ice on the walls of the frost fractures rather than a buildup of it. Along walls composed of permanently frozen rocks a dessication layer forms, in which the rock has a lower strength than in the massif. Crystals of sublimation ice which are present in the cracks form as the result of the exchange of air within the cracks, when the ice in a "warmer" area evaporates and accumulates in another "colder" area.

In regions with a highly continental climate, a severe deficit of moisture in winter, and thin snow cover, most of which evaporates by spring, unique polygonal-vein structures may form about frost fractures, out of which texturizing ice is sublimated in winter, and around which the ground is drained. The formation of such PVS may be accompanied by the accumulation of sublimation ice in the cracks in the spring, and the infilling of their lower portions with pieces of dessicated rocks which fall from the walls. In some years melt water flows into the cracks in the spring and veins of congelation ice form. In the latter case, the formation of frost fractures in the following year should occur below the STL along the dried rock, which has low tensile strength, and not along the ice vein. Under such circumstances certain types of ice-soil veins develop in the permafrost.

Generally, the infilling of the frost fractures as described above may be provisionally called congelational-sublimational, keeping in mind that collapse of the dessicated rock from the walls of the cracks plays an important role. The temperature series established by us for this type of infilling is tentative. No special study was carried out of the structures themselves and they do not have individual names. They will probably include many polygonal-vein forms which form under the conditions of the high continental and very dry climate of Eastern Siberia. High-temperature varieties of such PVS are to be expected, in Southern Transbaikalia in particular.

PRIMARY

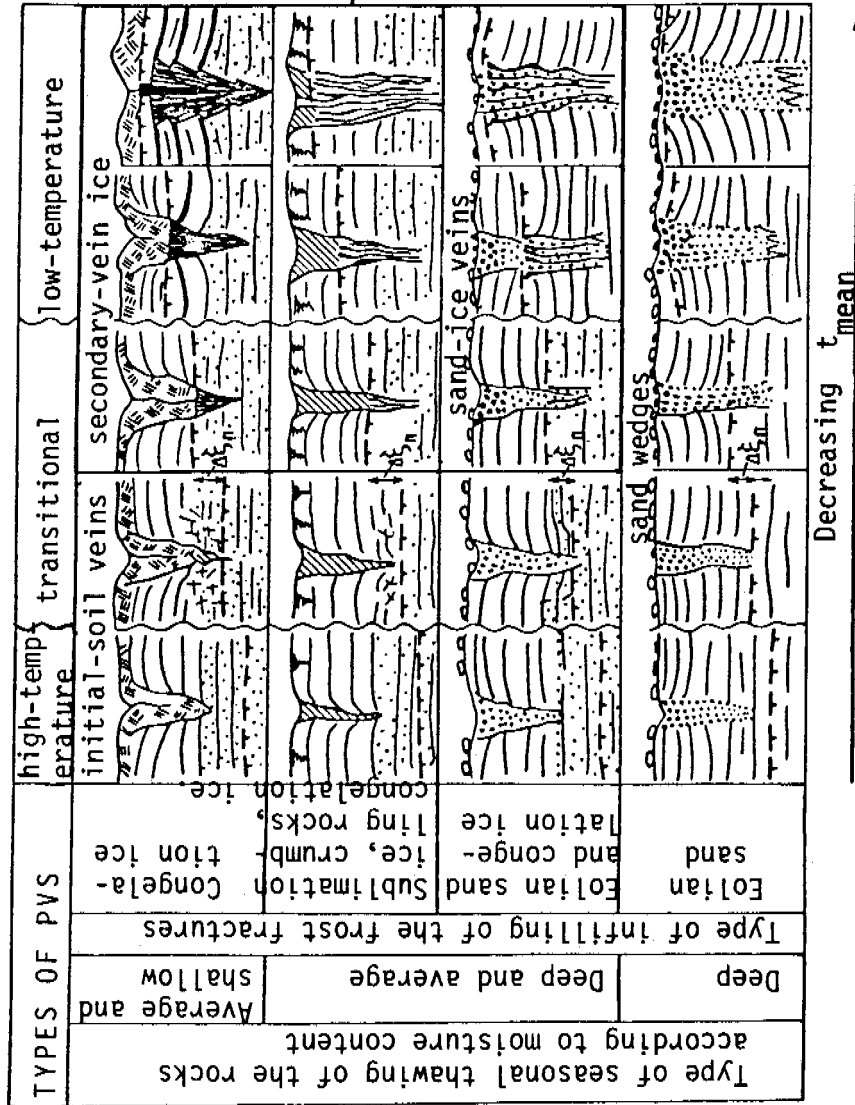

SECONDARY

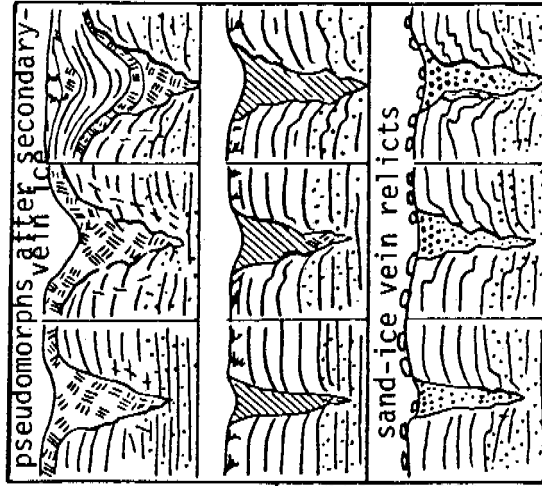

Basic scheme of the interrelationships of polygonal vein structures

Based on the main initial positions examined above, we have compiled a basic scheme of the interrelationships of polygonal-vein structures (see Figure), the left side of which shows the primary structures. The horizontal rows of these structures show the features which change in them with increasing severity (from left to right) of the temperature regime of the rocks (temperature control).

The vertical rows show the categories of PVS as the nature of infilling of the frost fractures changes. As indicated above, the infilling of such cracks depends on the moisture at the ground surface and on the presence of eolian transport of sandy material. There is also a casual relationship between the surface moisture and the moisture content of the rocks in the STL (SFL). Thus, when congelation ice forms in the cracks, seasonal thawing and seasonal freezing of the rocks is classified by moisture content, in accordance with V.A. Kudryavtsev's classification (Dostovalov, Kudryavtsev, 1967), as belonging to the shallow [ $W_{nat} > W_{uf} + 2/3 (W_h - W_{uf})$ ] and average [ $W_{uf} + 1/3 (W_h - W_{uf}) < W_{nat} < W_{uf} + 2/3 (W_h - W_{uf})$ ] types, where  $W_{nat}$  - is the natural moisture content of the rocks, being the average for the STL (SFL),  $W_h$  - is a rock moisture content of 100%, and  $W_{uf}$  - is the quantity of unfrozen moisture.

In the case of primary sand infilling, the seasonal thawing (freezing) is of the deep type [ $W_{uf} < W_{nat} < W_{uf} + 1/3 (W_h - W_{uf})$ ]. In the case of transitory types of frost fracture infilling, when the surface moisture content of the rocks changes from year to year, the moisture content of the rocks in the STL (SFL) also evidently changes. There cannot be complete synchronicity between changes in the nature of infilling of the cracks and the moisture content of the rocks because the former is determined by the surface moisture conditions in the winter and spring while the latter depends on the pre-winter conditions, the composition of the deposits, the degree to which the area is drained, etc. The limits of changes in the moisture content of the rocks are also not clear. As a first approximation on the basis of fragmentary data it may be supposed that the depths of the STL (SFL) with respect to moisture content vary from the shallow to the average types. Thus, the vertical axis in the proposed scheme of primary structures reflects moisture content control over the infilling of frost fractures and the depths of seasonal thawing (freezing) of the rocks.

At present, classification of PVS into epigenetic and syngenetic formations is generally known. Epigenetic PVS are those which have formed in rocks which have completed their process of accumulation prior to the start of development of the structures. Syngenetic PVS form simultaneously with accumulation of the deposits. In the proposed classification scheme for the interrelationships of PVS such a subdivision is not graphically represented, but it should be kept in mind that all types and varieties of the structures which have been distinguished can be either epigenetic or syngenetic.

Secondary polygonal-vein structures, which are shown on the left side in the Figure, are forms which appear when the ice contained in primary polygonal-vein structures melts. Thus, they can form from only certain types of PVS; firstly those classified as low-temperature formations, and secondly ones which have, as an integral part of the vein structure, inclusions of ice in a volume exceeding the  $W_h$  of the rocks which make up the vein in its thawed state. For this reason, the left side of the figure shows relicts of wedge ice (pseudomorphs after wedge ice), structures with congelation-sublimation infilling, and sand-ice veins. The conditions of formation of pseudomorphs after ice veins, are described quite completely in the literature (Kaplina, Romanovskii, 1972, 1973). Relicts of low-temperature PVS with congelation-sublimation infilling of the cracks have not received any attention so far. It is likely that they will have characteristics similar to those of pseudomorphs after small ice veins, and perhaps will not differ morphologically from them. Relicts of sand-ice veins have characteristics which are similar to pseudomorphs after ice veins, with inclusion of eolian sand in the structures as an additional characteristic.

The ice content of low-temperature sand-ice veins does not exceed a 100% moisture content for the unfrozen soil. Because of this, the structures themselves do not lose their primary morphological characteristics as they thaw. Moreover, the structural peculiarities of the sand and gravel which make up the veins are preserved in the fossil state.

It should be particularly emphasized that all types of PVS which form in the presence of a permafrost substrate, i.e., in STL and permafrost or in STL alone, including ones which do not contain ground ice, can undergo

certain changes when their growth ceases and the permafrost thaws. These changes will be more pronounced with increasing ice content of the permafrost. The effects of the ice content of the enclosing ground on the PVS relicts are dealt with in the literature most extensively for pseudomorphs after ice veins. Such studies are lacking or are of a very restricted nature for other types of vein structures. Probably the most complete description of the transformation of sand-ice veins and sand wedges in the process of the degradation of permafrost is found in the works of R. Black (1965) and I.Ya. Gozdzik (1973). The importance of this question is indisputable since, in particular, low-temperature fossil varieties of sand wedges may differ from high-temperature ones by the nature of their deformations, which developed as the depth of the seasonal thawing and degradations of ice-bearing permafrost increased. This is a subject for special research and is not dealt with in this paper. In distinguishing and classifying secondary structures we did not take into account deformations associated with the thawing of enclosing or underlying permafrost. For this reason sand-wedge relicts have not been specially distinguished either. Further research in this direction and improvement of the PVS "basic classification scheme" will make it possible to distinguish low-temperature sand-wedge relicts, and possibly also sand-ice veins, in accordance with the above principle.

It must be noted that developing polygonal-vein structures and ones which have stopped developing, i.e., in the conservation or burial stages, are not differentiated in the proposed "scheme". Such subdivision for each type of structure is possible, expedient, and is carried out in special geocryological research. Its introduction into the "basic scheme", however, would only complicate it without adding anything significant.

The proposed approach to the classification of PVS also does not take into account structures associated with "sorted" and "unsorted" polygons (Washburn, 1965). In our view, heaving and sorting of the rocky material are secondary phenomena in relation to frost fracturing and the development of vein structures.

The above approach to the classification of polygonal-vein structures, which takes into account "temperature control" over the position

of frost fractures and structures in the STL-permafrost system and "moisture level control" over infilling of the cracks makes it necessary to take a new approach to the taxonomy of these structures. Thus, "soil" ("earth") veins, which the majority of researchers differentiate as a single basic type of PVS, are subdivided into completely different types of veins which form under different permafrost-temperature and climatic conditions, which are sometimes diametrically opposite (for example, initial-soil veins and "low-temperature" sand-wedges). Finally, we propose that "primary" and "secondary" PVS be distinguished as basic groups, that within the group of primary PVS, types be distinguished by the nature of infilling of the frost fractures (types of infilling - congelation ice, congelation-sublimation ice, sand-ice composite, sand), and that structural types be distinguished (high-temperature, transitional, low-temperature) by the position of the frost fractures (and structures) in the STL (SFL) - permafrost system. Varieties of PVS can be distinguished within the types by the level of development, the morphology, and other features. It is expedient to divide all structures into two classes, depending on their relation to the enclosing ground, namely: epi- and synqenetic PVS. The taxonomy of a group of secondary structures subdivided in this manner is determined by the taxonomy of the respective categories of primary structures.

In conclusion, it should be mentioned that the proposed PVS classification scheme will permit researchers to devote their efforts to the search for suppositional structures, to establishing the distinguishing characteristics of structures belonging to different categories, and to the detailed delineation of the complex of conditions (including permafrost facies conditions) under which they can develop. A more detailed subdivision of vein structures will require new special methods of research (geothermal, geochemical, lithological, etc.), which is a task for the immediate future.

#### REFERENCES

1. DANILOVA N.S. Primary-earth veins in the Quaternary deposits of the Vilyuisk Region. In the book: Conditions and features of development of permafrost in Siberia and the Northeast. Moscow, Pub. of the AN U.S.S.R., pp. 25-40, 1963.

2. KAPLINA T.N. and ROMANOVSKII N.N. Pseudomorphs after polygonal-vein ice. In the book: Periglacial phenomena in the territory of the U.S.S.R. Pub. of Moscow State University, pp. 101-129, 1960.
3. KATASONOVA E.G. Cryogenic formations in seasonally thawing eolian deposits of Central Yakutia. In the book: Geocryological and hydrogeological research in Siberia. Yakutsk, pp. 80-89, 1972.
4. ROMANOVSKII N.N. The effect of the ground temperature regime on frost fracturing and the development of polygonal-vein forms. In the book: Permafrost research. No. 10. Pub. of Moscow State University, pp. 164-192, 1970.
5. ROMANOVSKII N.N. Main types of polygonal-vein formations, their characteristic features and conditions of development. Moscow University Bulletin, Geology Series, No. 6, pp. 44-57, 1972.
6. ROMANOVSKII N.N. and BOYARSKII O.G. Polygonal veins and earth veins in the northeastern part of the Vitim-Patom Plateau. In the book: Permafrost research. No. 6, Pub. of Moscow State University, pp. 124-143, 1966.
7. SHUR Yu.L. The transitional layer. In the book: Methods of geocryological research (Trudy of the All-Union Scientific Research Institute of Hydrogeology and Engineering Geology), pp. 82-85, 1975.
8. YANOVSKII V.K. Expedition to the Pechora River to establish the southern permafrost boundary. In the book: Trudy of the commission for the study of permafrost. Vol. II, Moscow-Leningrad, Pub. of the AN USSR, pp. 66-149, 1933.
9. BERG T.E. and BLACK R.F. Preliminary measurements of growth of non-sorted polygons. Victoria Land, Antarctica, Antarctic Soil-forming processes. - "Amer. Geoph. Uni. on Antarctic Research, Nat. Acad. Sci. - National Research Council", Ser. 8, Pub. 1418, pp. 61-108, 1966.
10. BLACK R.F. Ice-wedge casts of Wisconsin. "Wisconsin Acad. of Scie., Arts and Letters", Vol. 54, pp. 187-220, 1965.
11. GOZDZIK J. Genera i pozycja stratygraficzna struktur peryglacjalnych w Szrodkowej Polsce. - "Acta Geographica Ledziensia", N 31, Lodz, pp. 117, 1973.
12. PÉWÉ T.L. Sand-wedge polygons (Tesselation) in the McMurdo Sound Region. Antarctica - "A progress report.. Amer. Journ. Sci.", Vol 257, pp. 545-552.
13. ROMANOVSKIJ N.N. Regularities in formation of frost-fissures and development of frost-fissures polygons. - "Buln. Perigl.", N 23 Lodz, pp. 237-277, 1973.
14. WASHBURN A.L. Classification of pattern ground and review of suggested origins. - "Geol. Soc. Amer.", July, Vol. 67, pp. 823-866, 1956.

## OFFSHORE PERMAFROST IN THE ASIATIC ARCTIC

F.E. Are

Permafrost Institute, Yakutsk, U.S.S.R.

It is now certain that permafrost is widely developed beneath the Arctic Ocean and its surrounding seas. However, geocryological study of the sea floor is still in the very early stages. The great practical significance and the very inaccessibility of the offshore permafrost zone make it one of the most interesting and topical problems in present-day permafrost research.

One of the first communications concerning the presence of permafrost on the floor of the arctic seas was that of A.E. Nordenshel'd (1880), who observed that the sandy floor of one of the bays on the eastern coast of the Chukchi Sea was cemented by ice.

In a monograph by V.Yu. Vize and co-authors (1946), it was stated that on the floor in the Laptev Straits, ice had been found which did not thaw, due to the subfreezing temperatures of the water. There are no further elaborations.

On the whole, factual data on permafrost beneath the floor of the arctic seas have been, until recently, almost exclusively for coastal shallows. They have been collected mainly at the Institute of Permafrost Studies of the Siberia Branch of the Academy of Sciences of the U.S.S.R. by N.F. Grigor'ev (1966). Beginning in 1953, under his direction, a great number of borings were made which encountered perennially frozen or chilled earth materials near the receding coastlines of the open sea and in shallow gulfs, at a distance of several hundred metres from the shore; they were also



encountered on the shores of the estuaries of the rivers Yana and Indigirka, at a distance of 25 km from the outer limit of the delta. In all cases the depth of the water was less than 2 m.

During the period 1962-1972, under analogous conditions, E.N. Molochushkin studied the perennially frozen and chilled materials of the receding shorelines of Mostakh Island in Buor-Khara Bay, of Vankina Bay in the Laptev Sea (1973), and the channels on the shores of the Lena estuary in the region of Olenekskaya.

The first information on the presence of an offshore permafrost zone beyond the limits of the 2 m isobath came from V.M. Ponomarev (1960, 1961) for Kozhevnikov in Khatanga Bay, where many boreholes revealed perennially frozen and chilled earth materials. In one of the boreholes, at 3 km from the shore and at a depth of 3 m, the permafrost proved to be 66 m thick.

In 1970, when E.N. Molochushkin (1973) took samples of floor deposits in Ebelyakhskaya Bay and in the Laptev Straits, permafrost was found in the lower part of the core sample in several locations, at a distance of 30 km from the shore.

According to a report by L.A. Zhigarev and I.R. Plakht (1974), there are perennially frozen unconsolidated materials with high ice content in an underwater bar in Vankina Bay on the Laptev Sea, 10 km from shore and at a depth of 86 m above the sea floor. The depth of the water is not indicated.

The discovery of oil in Prudhoe Bay, Alaska, in 1968 was a strong impetus for research and development in the arctic regions of the U.S.A. and Canada. In 1969 there was a report of the presence of permafrost beneath Deception Bay in Northern Quebec, Canada (Samson, Tordon). According to B.P. Pelletier (oral communication, 1970), freshwater ice was extracted from the sea floor in the northwest part of the Canadian Arctic archipelago between Prince Patrick Island and Borden Island, at a depth of 10 m (Mackay, 1972).

In the spring of 1970, near the Canadian coast in the southern part of the Beaufort Sea, between Herschel Island and Liverpool Bay, cores of ice and frozen unconsolidated deposits were extracted from four wells when drilling on the sea floor for oil; these were studied in detail by J.R. Mackay (Mackay, 1972). The boreholes were located from 3 to 25 km from the shore, at points where the depth of water was from 8 to 17 m.

In the summer of 1970, a frozen core with freshwater ice lenses was obtained from the floor of the Beaufort Sea, 30 km north of Bathurst Inlet and at a depth of 37 m, by the Geological Survey of Canada (Yorath et al., 1971; Reimnitz et al., 1972).

In this way, it was empirically proven that permafrost is found beneath the arctic seas several tens of kilometres from shore, at a depth of several tens of metres.

On the basis of general considerations and very limited factual information, I.Ya. Baranov (1958) divided the permafrost into two offshore zones. The first extends over the whole of the Asian arctic shelf to the 100 m isobath; the second, over the coastal regions of the Kara, the Laptev and the East-Siberian seas to the 20 m isobath. This permafrost formed in the Pleistocene, and partially in the Holocene, when the shelf was dry. The first zone became submerged as a result of marine transgression; the second as a result of abrasion at "normal" sea level. In Baranov's opinion, the permafrost is in a stage of degradation at the present time.

The possibility and the inevitability of the perennial existence of offshore permafrost is conditioned by constant subzero temperatures of the layers of sea water over most of the arctic seas and the Arctic Ocean. The thermal conditions of arctic waters have been studied in considerable detail. Therefore, it is now fully possible to compose a map of the distribution of offshore permafrost as was done by A.L. Chekhovskii (1972) for the shelf of the Kara Sea. But it is much more difficult to determine the thickness of materials with subzero temperatures, and even more so to explain the morphology of the permafrost. In order to solve this problem, there must be a rational combination of geophysical research methods supported by borings. Rough forecasts could be obtained by calculation.

The following should be listed among the most important factors influencing the formation of the permafrost zone: relative levels of the sea and dry land, the climate and temperature of the sea floor; the Earth's internal heatflow; mineralization of the layers of sea water directly above the sea floor and of the waters immediately below the sea floor; the properties of the minerals forming the sea floor; the processes of abrasion and accumulation of sea floor deposits.

Each of the above factors will be examined in greater detail.

Relative changes in the levels of the sea and the dry land cause transgressions and regressions of the sea and consequently the submerging and drying out of the Earth's surface; this radically changes the temperature regime of the earth materials and the hydrogeological conditions of their development. A great amount of scientific research, the results of which are in many instances contradictory, is devoted to explaining either directly or indirectly the history of marine transgressions in the Earth's geological past.

At the present time, it is generally recognized that shoreline displacement is the result of the complex interaction of both tectonic and glacio-isostatic movements of the lithosphere and glacio-eustatic fluctuations in the ocean level. The process having the longest duration, a process that formed a background against which all other processes developed, is the inidirectional tectonic uplifting of the land and the formation of the ocean troughs during the Quaternary. During the last million years, according to P.A. Kaplin (1973), the ocean level has been lowered in this way by 100 m in relation to the dry land. It was against this background that the quicker glacio-eustatic fluctuation in the ocean level took place, the limit of which was approximately 120 m in the Quaternary.

With regard to the intensity and amplitude of the glacio-isostatic movements, the opinions of the various researchers are widely divergent. In a number of publications which have appeared in the last few years, it has been proven that the most recent vertical movement, at least in some coastal regions of the Soviet Arctic, were essentially conditioned, not by

glacio\_isostatic, but by tectonic causes. Most researchers agree that resultant vertical movements of the lithosphere in the coastal zone of the arctic seas for the Pleistocene and the Holocene was, on a regional level, very uneven, attaining several tens of metres in individual structures.

With the advent of the radiocarbon dating method for establishing the absolute date of earth materials, it was possible to make a qualitative study of the rate of changes in the ocean level during the last 30 years.

H. Godwin, R. Fairbridge and a number of other researchers have shown that in the period between 17,000 and 6,000 years ago there was a eustatic rise of 100 m in the ocean level; this developed at a relatively even pace, with an average speed of approximately 9 m per 1,000 years. During the past 6,000 years the ocean level has experienced eustatic fluctuations within the limit of no more than 10 m. There were also alternating fluctuations of the ocean level during the period of intensive transgression, but for the present, no reliable explanation of their chronology or amplitude is possible.

Rough estimates and simulation on a hydro-integrator show that, for a quantitative estimate of the possible present day permafrost zone beneath the arctic seas, the dynamics of shoreline displacement must be explained in time and space for the past 20,000 - 30,000 years.

It is obvious that the one-directional regression of the ocean in the Pleistocene can be disregarded, since for the period of time under study, it comprised at the most 2 - 3 m. As far as the glacio\_eustatic fluctuations in the ocean level are concerned, they have been well studied; the main problem is an explanation of the glacio-eustatic and neotectonic changes.

Analysis of results to date shows that on the arctic coastline of the U.S.S.R. it was the uplifting of the land which predominated in the Upper Pleistocene and the Holocene; its magnitude decreases in an easterly direction from the Kola Peninsula and Franz Josef Land to the shores of the Laptev Sea and the East Siberian Sea. Beyond this point it increases slightly towards the Chukchi Peninsula (Kaplin, 1973).

The contributions of G.I. Lazukov (Markov, Lazukov, Nikolaev, 1965) are devoted to the history of the development of the coastline of the Kara Sea. According to his scheme, transgression was taking place all the time, beginning with the Middle Pleistocene, in the northwest part of the West Siberian Lowland. At the beginning of the Holocene, a shelf existed in the Kara Sea as far as the 15 - 20 isobath. The present-day shoreline was formed in the Middle Holocene and has remained unchanged ever since. There was no transgression on the West-Siberian Lowland in the Pleistocene.

The most detailed scheme of development for the shelf in the Laptev Sea was drawn up by S.A. Atrelkov (1965). In his opinion, at the time of the Zyrian\* glaciation the whole shelf became dry land. Transgression took place in the Karginian\* period as a result of which the shoreline on the Taimyr became almost coincident with the present day line; from the Anabar to the Lena it stretched 50 - 100 m further out to sea; further to the east, it ran towards the northern extremity of the New Siberian Islands. At the beginning of the Sartanian\* period it fell by approximately 50 m, and at the end of the period, it rose for a short while to 15 - 20 m above the present level. The proposed rise in sea level is improbable. A considerable part of the shoreline of the Laptev Sea was made up of unconsolidated deposits with a high ice content which were formed no later than the middle of the Upper Pleistocene. They are only slightly eroded by the sea and therefore ought to have retained traces of the shoreline which had formed when the sea level rose in the Sartanian period. However, there are no such traces.

Towards the beginning of the Holocene, the sea level again fell, to 20 m below the present day level. The general consensus is that a transgression developed during the first half of the Holocene and finished 5,000 years ago at the present day level. This date is supported by several zoological, and more particularly, archaeological data in the work of V.D. Dibner and K.N. Nesis (Govorukha, 1968).

In the literature, the history of the development of the shelf in the East Siberian Sea is treated in less detail than is the shelf in the

---

\* The Russian term for the respective glaciations are: Zyryanka, Sartanka. The third term could not be found (Transl.).

Laptev Sea. According to S.A. Strelkov, during the Zyrian period the sea level was 40 - 50 m lower than the present level; in the Kargian period it fell by approximately 15 m; and in the Sartanian time it fell 50 m. Other events unfolded in the same way as those in the Laptev Sea.

To a depth of some 100 m the shelf in the Chukchii Sea became dry land in the Zyrian period, according to D.M. Hopkins (Hopkins, 1959). The Bering Strait did not exist. In the Karginian period the sea level rose to the 40 m isobath, and at the beginning of the Sartanian period it fell again by 10 - 30 m. Alaska's present level became established about 5,000 years ago.

Analysis of data on the relative levels of the arctic seas of Asia shows that, at present, large errors of thousands of years and hundreds of kilometres are possible when drawing up a scheme of shoreline dislocation for any part of the shelf, even for the Holocene.

It is the climate, and above all, its thermal characteristics and its changes in time, which determine the development of a permafrost zone. It is well known that the climate changed more than once in the Quarternary, and very significantly.

The main trend in the Pleistocene was a general cooling of the climate. Against this background, lesser fluctuations developed. It is generally accepted that during the warming period the climate was similar to the present climate, or somewhat milder, and that during the cooling period, it was considerably more severe. G.I. Lazukov (1961) and D. Clark (1974) maintain that the arctic climate in the Pleistocene was never warmer than the present day climate. There are grounds for proposing that throughout the Pleistocene and the Holocene the climatic conditions assured the uninterrupted existence of the permafrost zone. It is possible that during the Holocene climatic maximum there was partial degradation of the permafrost zone, but that it wrought no radical changes in the frozen landscapes of the arctic coastline.

Present-day knowledge is not sufficient to furnish conclusive evidence of the quantitative characteristics of the Paleoclimate of the

Quaternary. Therefore, the majority of researchers restrict themselves to careful approximate comparisons of past climates with the climate of today.

One of the most detailed qualitative schemes of changes in mean annual air temperature during the past 75,000 years was drawn up by E.I. Ravskii (1969) for the southern half of East Siberia. This scheme corresponds to the data of R. Bowen (1969) on changes of climate in the middle latitudes of the northern hemisphere in the Upper Pleistocene and the Holocene. However, the author himself points out how little is known on the subject. An analogous scheme for Central Yakutia, based on the study of a cross section of Mt. Mamontovo was drawn up by K.K. Markov and A.A. Velichko (1967). It differs substantially from that of E.I. Ravskii.

Climatic conditions along the arctic coast in the Sartanian period were, without doubt, more severe than today, mainly because, with a sea level of 100 - 140 m lower than the present level, access by the warm Atlantic waters to the Arctic Basin was considerably curtailed (Belov, Lapina, 1961; Govorukha, 1968). The climatic conditions must have been close to those of present day Antarctica. At present, the mean annual air temperature at the South Pole is  $-48.5^{\circ}\text{C}$ ; at the pole of inaccessibility it is  $-56^{\circ}\text{C}$ . The mean annual temperatures attributed to the sea level, based on a world-wide mean vertical gradient of  $0.5^{\circ}\text{C}/100\text{ m}$  will be  $-34.5^{\circ}\text{C}$  for the South Pole and  $-37.4^{\circ}\text{C}$  for the pole of inaccessibility. The mean annual air temperature at the North Pole during the marine regression was probably no higher than the given values, i.e., 15 to  $18^{\circ}\text{C}$  below the present temperature of  $-19^{\circ}\text{C}$ . On the basis of the latitudinal temperature gradient, it can be assumed that the mean annual air temperature on the arctic coast of Asia at that time was no higher than  $-25^{\circ}\text{C}$ .

The temperature of the bottom water of the Asiatic seas having a continental shelf have been well studied. As a rule, it is below zero, whatever the season. An exception is the zone of warming effect of the rivers, and the eastern part of the Chukchii Sea (Sovetskaya Artika, 1970). During the period of regression, it was probably closer to the freezing point, owing to the more severe temperature climate of the bottom water.

The opinion prevails that the air temperature during the Holocene climatic maximum rose by  $2^{\circ}\text{C}$  with respect to the present temperature (Bowen, 1969; Ravskii, 1969, and others). Taking into consideration the great thermal inertia of the water masses, it should be considered that the water temperature rose considerably less.

The continental slope, the channel bottoms and the deeper parts of the arctic seas are washed by Atlantic waters at a depth of from 200 to 900 m; the sea waters have above-freezing temperatures of from  $0.2$  to  $1.5^{\circ}\text{C}$ .

In the depths, situated between the Lomonosov Ridge and the Bering-Kara shelf, the deep water temperature is  $-0.7$  -  $-1.0^{\circ}\text{C}$ . During the regression, the temperature of the bottom water within the whole Arctic Basin was apparently close to freezing, i.e.,  $-1.8^{\circ}\text{C}$ .

The Earth's internal heat flow has an influence on the permafrost zone. A large part of the asian arctic coastline is characterized by a flow of  $0.04$  to  $0.06$   $\text{kcal}/\text{m}^2$  per hour.

Research on heat flow outward through the ocean floors was begun in 1952. A series of tests was made in the Arctic Ocean. The submerged mountain ridges of the Soviet sector of the Arctic proved to be a region of heightened thermal activity. For example, within the Lomonosov Ridge there was a variation in heat flow of from  $0.05$  to  $0.10$   $\text{kcal}/\text{m}^2$  per hour, and in the Makarova Trough of from  $0.05$  to  $0.07$   $\text{kcal}/\text{m}^2$  per hour (Lyubimova et al., 1973). Taking into account that, according to the present view, the arctic shelf is a natural continuation of the continent, it can be assumed that the heat flow is close to that of the coastline, that is, approximately  $0.05$   $\text{kcal}/\text{m}^2$  per hour with possible deviations in the order of  $\pm 15\%$ .

Mineralization of sea water and bottom water has a great influence on the phase composition of the materials forming the sea floor on the continental shelf. Highly mineralized waters facilitate the freezing of the mixing materials and form supra-, intra-, and subpermafrost water-bearing zones. Their distribution on the shelf is not known; the patterns of their formation and their interaction with the permafrost have received little attention.



Upon contact of the mineralized water-bearing zone with the permafrost at a sub-zero temperature higher than the freezing point of the pore water solution, the freshwater ice melts, filling the pores with frozen earth materials. An increase in the mineralization of the pore water solution near the boundary of the permafrost (essential for the formation of freshwater ice) takes place by way of migration of ions, induced by the concentration gradient, which decreases as the process develops. Thus in the absence of a pressure filtration process, it slows down automatically.

In the opinion of V.M. Ponomarev (1961), the melting of ground ice when exposed to sea water can only extend to a depth of a few metres. This is indirectly supported by laboratory tests conducted in the Institute of Permafrost Studies, Siberian Branch, Academy of Sciences of the U.S.S.R. by L.V. Chistotinov and L.G. Rogovskaya, who showed that the thawing of ice saturated fine-grained materials contiguous with the mineralized water at a temperature below freezing decreases with an increase in the depth of thaw and the fineness of the materials, and also with a decrease in mineralization of the water.

With the help of a sampling tube E.I. Molochushkin (1973) discovered both desalinated thawed and frozen floor deposits in the Laptev Straits and Ebelyakhskaya Bay on the Laptev Sea, at a distance of 25 km from the shore, where offshore conditions had prevailed for thousands of years.

The length of the cores extracted from the floor in various samplings of the arctic shelf does not exceed 6 m, and for the most part comprises tenths of a metre. In the Laptev Straits and in Ebelyakhskaya Bay the sampling tube did not penetrate the floor for more than 3.5 m (Molochushkin, 1973). Apparently, in many instances, the depth to which the tube could penetrate was restricted by the depth of the permafrost. Thus, because of the melting of the ground ice resulting from the action of the saline sea water, it is unlikely that a sufficiently thick layer of frozen deposits could form.

In the zone of present-day accumulation in the Laptev Sea, frozen floor deposits cemented by ice and at a temperature down to  $-6^{\circ}\text{C}$

(Molochushkin, Gavril'ev, 1970) were discovered and studied. An interesting feature of these deposits is the fact that the mineralization of the pore solution is considerably higher than that of the sea water. The cause has not been explained. The presence on the floor of the arctic shelf of deposits not cemented by ice gave some researchers reason to question the possibility of the existence of frozen materials at considerable distances from the shore (Govorukha, 1968; Semenov, 1973). However, the factual data presented at the beginning of this paper, refutes this opinion. The frozen state of the deposits on the arctic shelf is evidence that these are present-day marine sediments.

The characteristics of the earth materials which form the floor of the Arctic Ocean, and which must be considered in the thermophysical calculations of the parameters of the permafrost, have hardly been studied. Their characterizing values can only be assigned on the basis of the general concepts of geological structure of the sea bottom and on tentative assumptions. The results of this can be seen from the example of the coefficient of thermal conductivity. According to the research by the Geothermal Laboratories, Permafrost Institute, Siberian Branch, Academy of Sciences of the U.S.S.R., the coefficient of thermal conductivity of the most widely distributed earth materials in Yakutia varies from 1.5 to 4.5 kcal/m per hour  $^{\circ}\text{C}$ , that is, it can differ by a factor of three. The stable thickness of the permafrost zone is directly proportional to the value of the coefficient. Consequently, depending on the choice of the value for the coefficient of thermal conductivity, the calculated thickness of the permafrost zone can differ by a factor of three.

The processes of erosion and accumulation in the coastal zone, without doubt, had, and still have, considerable influence on the development of the permafrost zone on the shelf. Within the limits of the maritime lowlands of Siberia the present-day sea level was apparently established in the middle of the Holocene, that is, 5,000 years ago. During this time, thermal abrasion has developed intensely. On the basis of present-day observations, it can be assumed that, when exposed to thermal abrasion, shoreline regression proceeds at a speed of from 2 to 6 m per annum, and in places up to 10 m per annum. This indicates that, in the second half of the

Holocene, in many places where there was no change in the sea level, the shoreline receded on an average by 10 - 30 km, and by a maximum of 50 km.

As a result of thermal abrasion, very thick continental permafrost was now situated beneath the sea. Its fate depended to a great extent on the distribution of the warming and distilling influences of the rivers. These distribution areas have been studied in detail with respect to large rivers. It is also known that river waters on the shelf do not descend lower than 20 m (Sovetskaya Artika, 1970). When exposed to river waters with temperatures above freezing, there was degradation of the continental, submerged permafrost. Rough calculations by E.N. Molochushkin (1970) show that, in these regions, depending on the distance from the shore and the rate of regression, to date, permafrost could either melt completely or remain at some depth below the sea.

Outside the zone affected by the rivers, the below freezing temperature prevailing on the sea floor was considerably higher than the temperature on the land. In this case, there was partial degradation of the permafrost from below, and a rise in its temperature to an equilibrium corresponding to the temperature of the bottom water.

New permafrost can form in the zone of accumulation of present-day floor deposits. Their formation is strongly dependent on the mineralization of the sea water. On estuary shorelines where there is both fresh and slightly saline water, perennial freezing of the floor starts when there is a reduction in the depth of the water to about 1.5 m (Grigor'ev, 1966).

Outside the zone affected by the rivers, perennial freezing of the floor requires that the water be shallower, depending on the salinity of the sea water and the floor deposits. It should be emphasized that a reduction in the depth of the water when there is any kind of natural mineralization of the sea water and pore water in the floor deposits leads to perennial freezing of the sea floor, so when shallows are exposed at sea level, the mean annual temperature of their surface falls to  $-10 + -12^{\circ}\text{C}$ .

The permafrost zone of the Arctic Basin. The deep part of the Arctic Basin can be divided into two parts: the deep, where the water is

below freezing (sovetskaya Arktika, 1970), and a zone where the water is from 200 to 900 m. The latter is washed by Atlantic waters with temperatures above freezing.

Apparently, there is a stable permafrost zone below the floor of the deep. On the sea floor are unconsolidated marine depositions several hundred metres thick. The coefficient of thermal conductivity of such deposits is approximately 1.5 kcal/m per hour °C. The Earth's internal heat flow is from 0.05 to 0.07 kcal/m<sup>2</sup> per hour. The data given is for a permafrost zone of 15 - 30 m in the Nansen Basin and of about 10 m in the Beaufort Basin. The floor deposits within the permafrost zone are frozen.

In the region of the underwater ridges there may be an absence of sediment cover in places. The coefficient of thermal conductivity and the abyssal heat-flow must be relatively high here. Under such conditions, the thickness of the permafrost is in the order of 25 m. It can reach a maximum of 70 m.

In the Atlantic water zone, the temperatures are above freezing. Simple calculations show that there is no permafrost zone here.

Conclusion. Analysis of the given data shows that the offshore permafrost zone occupies a large part of the Asian arctic shelf and the Arctic Basin. It is absent from the upper part of the continental slope and from the deepest parts of the arctic seas (depth 200 - 900 m), and possibly from the areas with the warming effect of large rivers, when there is a depth of no less than 20 m.

Relic permafrost occurs in the coastal strip of the shelf 10 - 30 m wide, providing it became submerged as a result of thermal abrasion. It can only exist in that part of the shelf which became dry land in the recent geologic past. Outside these areas, the earth materials of the offshore permafrost zone exist in a chilled state.

The thickness of the permafrost zone in the deep part of the Arctic Basin between the Barents-Kara shelf and the Lomonosov Ridge is in the order of 15 - 30 m; beyond the ridge it is in the order of 10 m.

REFERENCES

- BARANOV, I.Ya. Nekotorye zakonomernosti razvitiya tolshch mnogoletnemerzlykh gornykh porod i sezonnogo promerzaniya pochvy. (Some patterns of formation of permafrost and seasonally frozen ground). "Izv. AN SSSR, Ser. geograf.", No. 2, pp. 22-35, 1958.
- BELOV, N.A. and LAPINA, N.N. Donnye otlozheniya arkticheskogo basseina. (Bottom deposits of the Arctic Basin). L., "Morskhoi transport", p. 150, 1961.
- BOWEN, R. Paleotemperaturnyi analiz. (Paleotemperature analysis). L., "Nedra", p. 207, 1969.
- VIZE, V.Yu. et al. Sovetskaya Arktika. Morya i ostrova. Fiziko-geograficheskaya kharakteristika. (Soviet Arctic. Seas and Islands. Physical Geography). M-L., Izd-vo Glavsevmorputi, p. 150, 1946.
- GOVORUKHA, L.S. Ya.Ya. Gakkel' ob Arktike. (Ya.Ya. Gakkel': The Arctic) -V kn.: Problemy polyarnoi geografii. (Problems of Polar Geography). L., Gidromoteoizdat, Trudy AANII, t. 284, pp. 31-51, 1968.
- GRIGOR'EV, N.F. Mnogoletnemerzlye porody primoskoi zony Yakutii. (Permafrost of the Coastal Region of Yakutia). M., "Nauka", p. 180, 1966.
- ZHIGAREV, L.A. and PLAKHT, I.R. Osobennosti stroeniya, rasprostraneniya i formirovaniya subakval'noi kriogennoi tolshchi. (Features of structure, distribution and formation of offshore permafrost). -V kn.: Problemy kriologii (Problems of Cryolithology). vyp. 10, Izd-vo MGU, pp. 115-124, 1974.
- KAPLIN, P.A. Noveishaya istoriya poberezhii mirovogo okeana. (Recent history of the Ocean Coastline). Izd. MGU, p. 265, 1973.
- CLARK, D. Paleoeкологиya i osadkonakoplenie v nekotorykh chastyakh Arkticheskogo basseina. (Palaeoecology and sedimentation in parts of the Arctic Basin). -V kn.: Chetvertichnoe oledenenie Zemli. (Quaternary Glaciation of the Earth). M., "Mir", pp. 227-241, 1974.
- LAZUKOV, G.I. O sinkhronnosti i metakhronnosti chetvertichnykh oledeneni i transgressii. (Synchronism and Metachronism of Quaternary Glaciations and Transgressions). -V kh.: Paleografiya chetvertichnogo perioda SSSR. (Paleogeography of the Quaternary Period in the U.S.S.R.). Izd-vo MGU, pp. 139-150, 1961.
- LYUBIMOVA, E.A. et al. Obzor dannykh po teplovym potokam v SSSR. (Heat flow data for the U.S.S.R.). -V kn.: Teplovye potoki iz kory i verkhnei mantii Zemli, Verkhnyaya Mantiya. Resul'taty issledovaniya po mezh-dunar. geofizicheskim proektam No. 12. (Heat flow from the Earth's Core and Upper Mantle. Upper Mantle, Results of the International Geophysical Project No. 12). M., "Nauka", pp. 154-195, 1973.

- MARKOV, K.K., LAZUKOV, G.I. and NIKOLAEV, V.A. Chetvertichnii period. (Quaternary Period). T. 1, Izd-vo MGU, p. 371, 1965.
- MARKOV, K.K. and VELICHKO, A.A. Chetvertichnii period T. III. Materiki i okeany. (Quaternary Period v. III. Continents and Oceans). M., "Nedra", p. 440, 1976.
- MOLOCHUSHKIN, E.N. Teplovoi rezhim gornyykh porod v yugo-vostochnoi chasti morya Laptevykh. (Thermal Regime of Earth Materials in the South-East of the Laptev Sea). (Avtoref. kand. diss.). M., p. 20, 1970.
- MOLOCHUSHKIN, E.N. Vliyanie termoabrazii na temperaturu mnogoletnemerzlykh porod v pribrezhnoi zone morya Laptevykh. (Influence of thermal abrasion on permafrost of the coastal region of the Laptev Sea). -P Mezhdunar. konf. po merzlotovedeniyu. Dokl. soobshch. vyp. 2. Yakutsk, pp. 52-58, 1973.
- MOLOCHUSHKIN, E. N. and GAVRIL'EV, R.I. Stroenie, fazovyi sostav i termicheskii rezhim gornyykh porod, slagayushchikh dno pribrezhnoi zony morya Laptevykh. (Structure, phase composition and thermal region of earth materials comprising the floor of the coastal region of the Laptev Sea). -V kn.: Severnyi Ledovityi okean i ego poberezh'e v kainozoe. (The Arctic Ocean and its coastline in the Cenozoic). L., Gidrometeoizdat, pp. 503-508, 1970.
- NEIZVESTNOV, Ya.V. and SEMENOV, Yu.P. Podzemnye kriopegi shel'fa i ostrovov Sovetskoi Arktiki. (Subsurface Cryopegs of the shelf and islands of the Soviet Arctic). -P Mezhdunar. konf. po merzlotovedeniyu. Dokl. i soobshch. vyp. 5, Yakutsk, pp. 103-106, 1973.
- NORDSHEL'D, A.E. Shvedskaya polyarnaya ekspeditsiya 1878-1879 gg. Otkrytie severo-vostochnogo prokhoda. (Swedish Polar Expedition 1878-1879. Discovery of the Northeast Passage). S.-Peterbur, p. 207, 1880.
- PONOMAREV, V.M. Podzemnye vody territorii s moshchnoi tolshchei mnogoletnemerzlykh gornyykh porod. (Subsurface waters of regions with thick permafrost). M., Izd-vo AN SSSR, p. 200, 1960.
- PONOMAREV, V.M. Formirovanie mnogoletnemerzlykh gornyykh porod i podzemnykh vod na mel'komor'e severnykh morei. -V kn.: Fiziko-khimicheskie protsessy v promerzayushchikh i merzlykh gornyykh porodakh. (Formation of permafrost and subsurface waters in the shallows of the Northern Seas). -V kn.: Fiziko-khimicheskie protsessy v promerzayushchikh i merzlykh gornyykh porodakh. (Physico-chemical processes in freezing and frozen earth materials). M., Izd-vo AN SSSR, pp. 95-101, 1961.
- RAVSKII, E.I. Osnovnye cherty klimatov Sibiri v antopogene Evrazii. (Basic features of the climates of Siberia in the Quaternary of Eurasia). M., "Nauka", pp. 111-120, 1969.
- SOVETSKAYA ARKTIKA (Morya i ostrova Severnogo Ledovitogo okeana). (Seas and Islands of the Arctic Ocean). M., "Nauka", p. 526, 1970.

- STRELKOV, S.A. Istoriya razvitiya rel'efa Sibiri i Dal'nego Vostoka. Sever Sibiri. (Historical development of the landscape of Siberia and the Far Eastern Regions). M., "Nauka", p. 336, 1965.
- CHEKHOVSKII, A.L. O rasprostraneni mnogoletnemerzlykh porod pod shel'fom Karskogo morya. (Permafrost distribution beneath the shelf of the Kara Sea). -V kn.: Geokriologicheskie issledovaniya pri inzhenernykh izyskaniyakh. (Geocryological research during technical explorations). M., Trudy PNIIS, t. XVIII, pp. 100-111, 1972.
- HOPKINS, D.M. Cenozoic history of the Bering Land Bridge. Science, vol. 129, N 3362, pp. 1519-1528, 1959.
- MACKAY, J.R. Offshore permafrost and ground ice, southern Beaufort Sea. Canada, Canadian Journal of Earth Sciences, vol. 9, n 11, pp. 1550-1561, 1972.
- REIMNITZ, E., WOLF, S.C. and RODEICK, C.A. Preliminary interpretation of Seismic profiles in the Prudhoe Bay area, Beaufort, Sea, Alaska. Open-file report. U.S. Dept. Inter., Geol. Survey, p. 11, 1972.
- SAMSON, L. and TORDON, F. Experience with engineering site investigations in Northern Quebec and Northern Baffin Island. Proc. 3rd Canadian Conference on Permafrost. NRCC, Tech. Mem. 96, pp. 21-38, 1969.
- YORATH, C.J., SHEARER, J. and HAVARD, C.J. Seismic and sediment studies in the Beaufort Sea. Geol. Surv. Can., Pap. 71-1A, pp. 242-244, 1971.

## STRUCTURE OF THE NORTHERN CIRCUMPOLAR PERMAFROST REGION

I.Ya. Baranov

Industrial and Residential Institute of  
Engineering Surveys in Construction  
Moscow, U.S.S.R.

The second criterion of the Earth's cryogenic process, apart from the lowering of the temperature of matter in the geosphere to below  $0^{\circ}\text{C}$ , is the crystallization of water; this occurs unevenly depending on its phasal states, and degree of freedom; which are due to the enclosing matter, mineralization, etc..

On this basis, the following conceptual categorizations can be made: freezing - associated with the crystallization of water; cooling - associated with the lowering of the temperature of matter to below the natural low point of crystallization of mineralized water (brine); super-cooling of water below  $0^{\circ}\text{C}$  (vapour; water which is sufficiently liquid to form drops; and mineralized liquid) in a stable or unstable state, by the inherent conditions for cooling and bonding with matter. As a result, the Earth's cryosphere is a region of frozen ground features, of cooling and super-cooling; there is interpenetration, with each form serving as either a continuation of, or interfering with, the other.

The differences between the cryogenic process\* and the processes of cooling and supercooling lies in the fact that, in the former, there is phase transition from water to ice with the release of latent heat; in cooling, either latent heat is not released or it is only released momentarily during transition. This unconditionally plays an important role in the formation of seasonally and perennially frozen earth materials and

---

\* Cryogenic processes: physico-chemical processes resulting from energy and mass exchange in freezing, frozen and thawing earth materials.



cooled materials; in the differences of their thermal inertia; their dynamics when exposed to uniform sources of heat; and in changes in their properties during freezing and warming, etc.

During cryogenic processes, the diapazone of energy- and heat-emission due to the phase transition of water into ice and ice into vapour-ice (which by-pass the liquid phase), depends on the degree of freedom of the water, its relationship with the enclosing matter and the forms of these relationships, and on mineralization. Therefore, crystallization takes place in a wide temperature diapazone; the relationship between the water, the enclosing matter, and the state of the latter, and the mineralization of the water substantially reduce the point of crystallization.

According to texture, the cryosphere is really nonuniform and complex; it is characterized by a combination of processes of crystallization, cooling, and supercooling of water, of the matter enveloping it (atmosphere, lithosphere) or shaping it (hydrosphere). Hence, the elements of the cryosphere are: the atmocryosphere, the lithocryosphere and the hydrocryosphere, each of which has its individual material characteristics related to the energy- and mass-exchange. All of the above are connected by the unity of their internal thermodynamic systems. Therefore, changes in one element inevitably leads to a change in the other elements.

Within the atmosphere (troposphere), at various temperatures and humidities, the basic frozen ground features are formed - snow and hail, developing from water vapour and droplets of water. When the temperature is low and there is low absolute humidity, supercooling of the moisture takes place. In a severe climate, there is crystallization of supercooled vapour and of vapour which has been sublimated from the frozen ground (snow) during sharp drops in temperature, and in still air, it forms a very fine ice spray (a suspension) of acicular crystals. Similar formations are also characteristic of the stratosphere.

The atmocryosphere enclosing the stratosphere, the mesosphere, and part of the troposphere have the form of an enveloping sphere which "leans"

on the circumpolar region and is bounded from above by the thermosphere (at a height of 120 km). The lower troposphere is very dynamic having a seasonally variable temperatures ranging from subzero to above zero values.

For the troposphere, perennial (even to geologically lengthy) pulsations are characteristic. These are manifest as contractions and expansions of the part with constant above-zero temperatures and form a "ring" that extends to the equatorial-tropical zone affecting (not systatically) the subtropic regions that are influenced by the warm seas and oceans; its altitude is not restricted. Above the equator, at an altitude of 5 - 6 km, the existence of snow and firn, ice and seasonally and perenially frozen ground is assured.

It is known that seasonal changes in the temperature of the troposphere are due to the movement of the Earth in orbit and to the angle of inclination of its axis. A change in the incidence and speed of the Earth's rotation causes a change in the climate of the planet, and of the quantitative and qualitative characteristics of the elements of the cryosphere.

The internal boundary of the atmocryosphere is formed by the mobile isothermic surface with a temperature of  $0^{\circ}\text{C}$ .

In preceding geological epochs, and in the Cenozoic, the atmocryosphere, particularly in the Quarternary, experienced substantial expansions during the epoch of falling temperatures, and contractions in the warming epochs.

In the lower troposphere (mainly to an altitude of 3.0 - 3.5 km), is concentrated the prevailing moisture, in its various phases. The upper surface of the sphere of great humidity is dynamic and is dependent upon changes in the temperature of the air and of the daytime surface temperature.

The temperature field of the atmosphere, as is well-known, is formed as a result of internal heat sources, mainly absorption of ultraviolet rays with a wave length of  $2000 < \lambda < 3000 \text{ \AA}$  (mesosphere and stratosphere),

and of apparent and infrared radiation with a wavelength  $\lambda < 3000 \text{ \AA}$  (Earth's surface, troposphere). Above the atmocryosphere (in the thermosphere) the thermal state is formed under exposure to shortwave radiation with a wavelength of  $\lambda < 1000 \text{ \AA}$ .

The remaining radiant energy of the second diapazone of the wavelengths is converted into heat energy which takes part in the internal thermal regime of the troposphere in its heat- and mass-exchange interactions with land and the oceans, their water and ice surfaces, and becomes subjected to the special features of the planet. Periods of cooling and warming and the dynamics of the atmocryosphere reflect shifts and changes in the Earth's internal thermodynamic system.

As is well-known, a consequent lowering of energy-exchange with increasing altitude is characteristic of the troposphere and its temperature field. This determines the altitudinal zonal elements of the lithocryosphere and the possibility of accumulative frozen ground features (ice covers), which change the landscape of the surface in circumpolar regions. A sequential lowering of energy-exchange away from the equator to the poles determines the latitudinal zonal elements of the cryosphere of the dry land and the oceans. Comparison of two spatial types of heat-exchange ( planar and altitudinal) creates a true schema for texture of the Earth's cryosphere, of the interaction of the enveloping elements on the basis of their differences in heat energy.

The stratosphere and the mesosphere, and the sphere of constant cooling play a decisive role in the thermal regime of the Earth, and in the Earth's development. They form the second step of the Earth's "cryogenic screen"; the troposphere, changed with time, is the first step. The Earth's "cryogenic screen" impedes the "escaping" of water vapours and their dissipation into the ionosphere; it substantially restricts this process. It is this very "cryogenic screen" that creates the stability of the hydrosphere, and the present day energy level at the Earth's surface, and establishes the possibility and the type of development of the materials in the lithosphere, and the development of the biosphere. The occurrence of the "cryogenic screen" at the boundary of transition from planetary development

to geological development has played, and continues to play, a special role; this role differs from those acting as similar "screens" on other planets in the solar system, for they have formed during different, less critical conditions and other combinations of determining factors and conditions.

Phase transitions of water, against a background of seasonal changes in the level of energy exchange between the land and oceans and the atmosphere, are manifest as the essentials of mass exchange in the troposphere, and exert an influence on the approach of radiant energy, influencing its absorption and radiation and its heat loss in various zones of the Earth. Ice covers, together with snow covers, exert an influence on the cold and warm seasons of the year, limiting heat penetration through albedo, and increasing heat-losses in thawing; this lowers the general energy potential at the Earth's surface. Their influence in a period of cooling plays the most substantial (global) role in the heat- and the mass-exchange of the Earth's enveloping elements, in the development of the cryogenic processes in the cryosphere.

Warming epochs have a substantial influence on the development and distribution of circumpolar regions, on altitudinal zones of frozen ground features and on the contraction of the cryosphere due to the Earth's enveloping elements.

Cooling epochs activate the development of frozen ground features and widen their spheres of distribution. In both cases, a change in the (changes in distribution) does not change its texture; this reflects unity in the cryosphere. The enveloping air plays a large role in this.

For the atmosphere, short-period (non-seasonal) and seasonal frozen ground features are characteristics; in the stratosphere, it is ice suspension (a non-seasonal feature), and when there is cyclonic turbulence, it is snow; in the troposphere, it is snow, sleet, hail, ice suspension and supercooled vapour; for the Earth's surface and objects, it is hoar frost, glazed frost, etc. They develop either by supercooling (vapour, water droplets), or by the presence of primary centres of crystallization (snow, hail). Their development is completed when they fall to the surface of the

land or oceans due to gravitational attraction, where they thaw, transforming into seasonal or perennial accumulative covers, or evaporate, or convert to droplets of water, without reaching the Earth's surface.

Latitudinal zonal changes in the energy level of exchange within the atmosphere is manifest in the formation of the Earth's thermodynamic belts.

The hydrocryosphere is characterized by its complex structure and boundaries. It comprises oceans and seas, and, in the case of dry land, lakes, rivers, etc.

The hydrocryosphere is polar and is divided into two circumpolar regions with distinguishing features. These regions are divided into subregions: ice covers, and the chilled waters of seas and oceans. The ice covers within the boundaries of seas and oceans are formed by a change in the physico-chemical composition of the water, and by distillation during crystallization. As is well-known, layers of water chilled below  $0^{\circ}\text{C}$  form in areas with seasonal ice-formation and regions of perennial marine ice; these are tens and hundreds of metres thick, and up to several (1 - 3) kilometres in polar regions. Regions with chilling of ocean waters lie within the boundaries of the permafrost regions of the continents (northern hemisphere), or within the region of potential development of permafrost (southern hemisphere). The near border zone is characterized by deep bedding of lenses of chilled water which outline regions where their distribution is uninterrupted (Okhotsk and Bering seas). The chilled water has a temperature of about  $-1.8$  to  $-1.9^{\circ}\text{C}$ , even in the warm season, corresponding to the mean annual temperature for this depth of water. In the cold season, the water below the ice has a lower temperature, and this allows the crystallization process to take place. The ice cover starts to form with the supercooling of the water and the formation of frazil ice.

The temperature field of the oceans and seas in circumpolar regions is characterized by a continental type of temperature distribution. Depending on the depth, the main body of water (shelf seas in the central part of the shelf, outside the direct influence of the warm marine currents;

polar ocean deeps) is at subzero temperatures in places, changing to above zero temperatures in extreme regions. For the extreme zones, a flow of chilled water is characteristic in near bottom areas of the ocean deep. Two chilled layers are observed within them: a surface layer and a near bottom layer. The boundary between the chilled water and the above zero water is determined by the thermodynamic equilibrium of the aqueous environment. In the zone with two layered chilling of water, the temperature curve changes, forming two bends into the region of above zero temperatures (the surface layer, even in a mass delimiting upper and lower layers). This situation is also characteristic where there is submergence of warm water (Gulfstream, etc.) into a cold mass of water.

For oceans outside the circumpolar limits, the characteristic distribution of water temperature by depth, is the reverse of continental distribution, i.e., basically it decreases with depth. Only in a few places, usually in areas of tectonic faults and fractures, and subaqueous volcanoes, is there an observable rise in the water temperature; this is associated with the considerable, deep, warm currents.

From geophysical data obtained during the last twenty years, it follows that the thickness of the Earth's crust beneath the ocean bottom varies within the limits of 5 - 10 km; while beneath the continents it is from 35 to 45 km, and in places, in mountain regions to 70 or even to 120 km. The great thicknesses of the Earth's crust restrict the magnitude of the internal heatflow. The presence of cold water in the near-bottom regions of the oceans, when there is limited thickness of the lithosphere, seems paradoxical.

The bottom of ocean deeps is composed of basalt, which is characterized by its high thermal conductivity; in the lithosphere and on its surface, there can be no mass- or heat-exchange typical of continental regions, only that which is capable of causing chilling resulting from direct heat exchange with the ocean waters. In such circumstances, considerable warming of the near bottom water might be expected, resulting from probable annual temperature gradients in the lithosphere below the ocean bottom of 10 - 20°/100 m. However, there is no observable warming of water, except in

rift zones. The heat flow through the ocean bottoms does not differ from that calculated for the ancient platform. This paradox cannot be explained by the chilling of the bottom of the deep, since movement of the near bottom layer of water is not great enough to counteract the influence of the deep heat flow corresponding to the temperature gradient, without leaving a trace in its temperature field. An increased heat emission through the ocean bottom must be manifest in a restraint on the chilling of the water, in particular, in the case of the Arctic Ocean, which is one of the main sources of chilling of water masses from contiguous areas of the oceans.

This very unusual temperature field in the hydrosphere occurs as a result of the arrival of heat from an external heat source, and by way of heat exchange with the air masses above the seas, oceans and continents, and also on account of the inflow of deep seated heat as a consequence of the thermal conductivity of the bottom rock and the subaqueous extrusion of magma.

It is well known that the redistribution of heat in the oceans takes place by means of wave motion, warm and cold currents, and convection which, together, play an important role in the formation of the climate above them and over the continents. A high degree of mixing of water in the oceans is restricted to the upper layer, which is up to 200 m thick. Global convection of water masses affecting great depths, and indirectly, even the near bottom layers of water, gives rise to cold currents. The temperature field of the oceans reflects the thermal state of the water, which depends not only on external sources of heat but also on the chilling inherited from cold epochs. It did not materialize in line with the thermodynamic conditions at the surface.

The transfer of moisture by oceanic air masses determines the formation of accumulative frozen ground features on land.

As for the temperature fields of the lakes and rivers, they exhibit either similar (lakes) or different (rivers) characteristics. For deep lakes, an oceanic type of distribution is usual. Wave dislocation and a normal temperature distribution to depths equal to the zone of dislocation

are typical (to 20 m or more). The formation of the ice cover is associated with a certain initial supercooling of the water and with subsequent crystallization of the intermediate volumes of water.

The formation of ice covers on rivers takes place with the participation of frazil ice, which assists in the acceleration of the formation of the ice cover and its growth from below.

For the hydrosphere, the following are characteristic: frazil ice, and seasonal and perennial ice covers. Lenses of chilled water and seasonal ice covers both correspond to the boundaries of frozen ground features on the continents and in the oceans; the perennial ice in the oceans occupies the most extreme circumpolar position, i.e., far from the permafrost boundaries. This is connected with the qualitative difference between the water mass and the earth materials.

Another frozen ground feature in the hydrosphere is ice of continental origin (icebergs), which is most widely distributed in the Southern Hemisphere with its vast continent. In the Northern Hemisphere the main sources of such ice are the east and southwest coasts of Greenland.

The lithocryosphere is characterized by the great complexity of the phenomenon of cryogenic processes. On land surfaces, non-accumulative and accumulative features develop. Non-accumulative features are divided into condensation-crystallization and migration-crystallization features. The former are associated with the near-surface layer of the air; the latter with heat exchange through the ground surface. To the first group belong: hoar frost, glazed frost, etc., to the second belong: "ice-stems" - "ice grass" and the related "ice druses", and "ice flowers", "ice tetragons", etc. Their formation takes place selectively on various surfaces (denuded ground, soils, snow, ice, vegetation, etc.) under various types of external conditions and development mechanisms. Their role is limited.

Accumulative features are widely distributed in circumpolar regions, and also in the south, in countries with high mountains. It is well-known that their basic form is snow cover. Under certain conditions, it



is transformed into firn, both as an independent feature (in flakes) and as an intermediate feature which transforms into the ice of glaciers and ice covers.

Snow cover influences the rate of freezing of earth materials and the temperature field of the underlying rocks is formed under its influence throughout the winter and into the beginning of the following warm season.

Perennial ice covers on land exert a considerable influence on the perennial freezing of their underlying materials. In this case, a single temperature field is formed for the ice cover and the permafrost layers. The ice cover removes the surface conditions which influence their dynamics.

To local formations belong seasonal and perennial icings of groundwater and surface water courses.

Within the lithocryosphere, the basic features are: frozen, chilled-frozen, chilled features and their chilled counterparts in earth materials. They are divided into short-period, seasonal and perennial. In distribution, they are either isolated or occupy the same regions of development, i.e., they are either connected or not connected with the transitions from one form to another.

Frozen and chilled-frozen materials are common types of frozen ground features in the lithosphere; they are formed by the crystallization of saturant groundwater which is either fresh water or water that is undergoing distillation (during crystallization). The difference between them depends on the composition and characteristics of the earth materials (granular, cohesive, fissured), and the degree of water saturation. In granular and cohesive (clayey) materials, crystallization of water takes place during freezing subject to its bonding with the particles of the earth materials as a function of the temperature spectrum with formation of various cryogenic structures. In fissured materials, the water crystallizes at a relatively uniform temperature. The distribution of ice depends on the degree of water penetration and on the types of fissuring, and their distribution in the rock mass.

Chilled ground results from the cooling of the materials (fissured or monolithic) to below  $0^{\circ}\text{C}$ , in the absence of visible water. Freezing is replaced by cooling. The properties of the materials do not change (monolithic nature, fissured state, porosity).

There is a basically different type of earth material, known as cooled material (below  $0^{\circ}\text{C}$ ), which falls into a separate category. It is saturated with mineralized (saline) water and is very common in Eurasia, and less common in South America, and within the confines of the shelf. We drew attention to this in 1956. Cooled materials replace frozen, chilled-frozen, and chilled materials. In the layer of seasonal freezing and in the upper part of the permafrost, there are many accompanying (short-period, seasonal and perennial) frozen ground features: polygonal-fissured heave, textural, etc. Their classification was given in 1962-1965.

The complexity of the Earth's cryosphere can be seen from the above; the diversity of the elements of the geosphere of which it is comprised, and of the classes, types and species and variety of features they contain.

The substantial differences between frozen ground features of the northern and southern circumpolar regions result from the non-uniform nature of energy at the Earth's surface, the geographical dislocation of continents, their areas, the dislocation of oceans, differences in types of matter forming the geosphere and their properties. This determines the polar and internal non-uniform structure of the cryosphere.

The Earth's cryosphere is characterized by its complex conjugate temperature field which reflects the non-uniform nature of energy and matter of the enveloping elements, of its surface, and of the matter-energy interaction.

In the vertical section, the cryosphere is divided into two subdivision, the boundary of which is the matter-thermodynamic interface. The lower subdivision is formed by the litho- and hydrocryospheres; the upper subdivision - by the atmosphere. Each of these elements of the cryosphere is

characterized by the inherent characteristics of the matter of which it is composed, by the method of formation, and by the differences in the dynamics of their temperature fields in compliance with planetary and cosmic conditions.

The temperature field of the lithosphere is formed under the influence of its internal heat source, which is of a complex nature (gravitational compression, radioactive decay, etc.) heat emission from the upper mantle - the asthenosphere. The deep seated heatflow (excluding local inclusions of magma), has an uneven influence, depending on the thickness of the lithosphere, its dynamics and properties (composition of the rock, tectonic activity, and directivity of movements in the Earth's crust, and its geological-tectonic structure). Judging by its influence on the lithosphere and its relationship with it, it would seem to be external; there are processes in the lithosphere which require great expenditure of heat (thermometamorphism of earth materials). The remaining heat generates a heatflow which forms the Earth's external exothermal zone. Its temperature field is formed with the participation of its own heat sources (radioactive decay, and geochemical reactions which have two thermal effects, etc.). They participate in the internal heat exchange. Its resulting heatflow, within geologically long period of time, is dynamic and depends on external thermodynamic causes and conditions. The external conditions exert an influence against a background of cryogenic processes (subsidence and uplifting of the Earth's crust). Their total influence is manifest in the range of depths (measured in kilometres) i.e., by the thickness of the lithosphere.

The magnitude of the resultant deep seated heatflow within the limits of the dry land and the ocean bottom is known to be several gram calories  $\text{cm}^2$  per annum; this is commensurate with the magnitude of heatflow being generated by the external heat source - the Sun. It is exactly this that creates the fundamental condition for the creation of the litho- and hydro-spheric elements of the Earth's cryosphere.

The level of thermodynamic equilibrium at the Earth's surface (mean perennial temperature) varies within the ranges of +25 to +30<sup>0</sup>C in the

Northern Hemisphere (Greenland), and to  $-60^{\circ}\text{C}$  in the Southern Hemisphere (Antartica). Glaciers, ice covers, and vast cooling regions lower the temperature of the remaining surface. Outside the regions of glaciation, there is a temperature variation of  $40$  to  $50^{\circ}$ ; within them, it increases to  $55$  to  $90^{\circ}$ . During the Cenozoic, the level of thermodynamic interaction between land, oceans and the external environment varied considerably: in the case of their uplifting, it was the Tertiary; and for subsidence, it was the Quarternary. In the Quarternary, there was an increase in heat emission in the external environment (this is the distinguishing characteristic of the period), especially in individual stages. Apparently it is the increased area of the continents in the polar regions of the hemisphere, resulting from several uplifts of the continental shelf, that is the cause of the cooling epoch. The orogenic processes of Southern Asia and Europe, South and North America, which did not lead to a global cooling of the elements enveloping the Earth, played a definite role in the formation of the general background preceding it. The role of the mountain systems is manifest in its restriction of penetration by air masses onto the continents.

The lowering of the level of thermodynamic interaction of the Earth enveloping elements during the cooling epoch was accompanied by the development of thick ice covers on the oceans, deep cooling of the ocean waters, glaciation of vast land surfaces, formation of regions of deep-seated cooling of earth materials over great areas, the strengthening of the role of cold marine currents, etc. Ice covers and glacial covers, by their expansion both areally and latitudinally, directly and indirectly reduce the general energy level of the Earth's surface. Glaciation of the land led to the differentiation of its surface regions; these were characterized by different conditions of cooling of the earth materials. The present day temperature fields of the oceans and continents are forming in accordance with the external thermodynamic conditions that are becoming established. The numerous nonconformities with present day conditions are evidence of intense cooling in the past, in some places, the no too distant past.

The structure of the Earth's cryosphere reflects the thermodynamic conditions that formed and exist in geologically long periods of time in the near surface zones of the enveloping elements in contact with it. It is dependent upon:

- a) the spherical shape of the Earth, the position of its axis, its distance from the Sun (solar constant);
- b) the presence of enveloping elements: enveloping (atmosphere), the element forming it (lithosphere), the superimposed (hydrosphere), and their spatial distribution;
- c) composition and properties of the matter forming the elements, their matter-energy interaction, the autonomous mobility or immobility of the constituent matter;
- d) the presence of water as the matter forming the elements, and as matter distributed within other environments, and as matter constituting the basis for development of the cryogenic processes and frozen ground features, by its properties, mineralization, etc.

Mobility and freedom of water have a special role in the heat- and mass-exchange (in the atmosphere, the lithosphere and the hydrosphere), which affects the development of the cryogenic processes, their intensity, and the spatial distribution and differences in their development in time.

In the formation of the Earth's cryosphere and its structure, all of the above factors and conditions which are found in specific relationships and interactions play a decisive role. Thus, the spherical shape of the Earth and the material differences of its enveloping elements play a decisive role in the nonuniform effect of its external heat source (solar radiation), which is different in each element comprising the inherent structure of the Earth's cryosphere. If, for example, the basic thermodynamic characteristic of Mars were transferred to Earth (reducing the flow of solar energy by 1.4 to  $0.6 \times 10 \text{ erg/cm}^2 \text{ s}$ ) then, in time, this would lead to freezing of the oceans, probably to a considerable depth, and to the establishing of a severe climate over the whole planet. Patterns of change in magnitude of solar

radiation from the equator to the poles forms a basis for the division of thermodynamic belts and regions, within the confines of which, conditions of development of the cryogenic processes are various.

For the equatorial-tropical zone, seasonal and perennial processes which only develop at altitudes greater than 5 - 6 km, are characteristic.

For temperature (transitional) zones, lower levels of energy are characteristic. Therefore, within its boundaries, the processes develop in regions where there is a lengthy lowering of air temperatures below 0°C. Perennial frozen ground features outside the permafrost region develop in mountainous countries, the absolute altitude of which exceeds 2000 m in the north and 3000 m in the south. Within the confines of plains they develop in regions where there is a systematic transition from seasonal to perennial freezing. For the subarctic and arctic regions permafrost and cooling of Earth materials is characteristic.

As is well known, the boundaries of the thermodynamic belts on land are latitudinally non-uniform, they are non-linear and discontinuous; this is connected with the influence of cold and warm marine currents, varying expanses and contours of the continents, and by the presence of mountain systems strengthening the continental nature and limiting the influence of the oceanic air masses.

For the Northern circumpolar region, the following dependence is characteristic: where warm oceanic air masses influence the continents, the southern boundary mingles with the subarctic and arctic environmental zones; where the continent is the source of climate formation, the southern boundary mingles, to the south, into the limits of the temperate zone. Mingling is most pronounced in mountainous regions within the continents.

The prevailing influence of the severe climate in the Arctic is manifest in the mingling of the southern boundary into the limits of the Atlantic and Pacific oceans, in the western part, i.e., in the Northern Hemisphere. In the Southern Hemisphere the influence of Antarctica leads to a displacement of the northern boundary over the Pacific, the Indian and the Atlantic oceans, far beyond its limits.

The surfaces of ocean waters are also warmed non-uniformly; a directional change in the level of energy exchange can be traced from the equator to the poles. Its schema of change is complicated by ocean currents: warm currents in the temperate belts and arctic regions, and cold in the equatorial-tropical zone and the temperature zones, mainly in the Northern Hemisphere.

The cooling of earth materials saturated with mineralized (saline) water, and the cooling of seas and oceans to below  $0^{\circ}\text{C}$  occupies a special place in the lithosphere and hydrosphere elements of the cryosphere. Seasonal spheres of cooling which form without phase transition of water into ice, or resulting from it, are: in the lithosphere - unconsolidated deposits (beaches, spits, bars, etc.) and fissured rocks; in the hydrosphere - bodies of water under ice covers in saline lakes, seas and oceans or over areas not covered with ice when there is wave movement and cold currents.

The perennial elements of the cooling part of the hydrosphere are restricted to the polar seas and oceans, where the thickness of the body of cooled water reaches several kilometres; it is similarly restricted to the seas of the arctic shelf.

Cooling of the oceanic bodies of water is connected with geologically long periods of cooling via the surface in conditions of low levels of energy exchange and convective submergence of cold volumes of water when there is near bottom outflow into the intermediate parts of the oceans (Southern Hemisphere) or into neighbouring oceans.

In continental conditions, the occurrence of cooled materials is connected with the conditions of the subaerial formation of low temperature permafrost, the continuation or replacement of which are the horizons of perennially cooled ground. The cooled earth materials have the same temperature field as that of the frozen ground.

In the northern regions of Siberia and Canada, within the confines of the ancient platforms and several troughs and Quarternary subsidences which were accompanied by transgressions, the cooled materials have a depth of several hundred metres, and in places, of more than a kilometre.

Within the limits of the shelf, in places below the bottom of the polar oceans where the whole body of water has a constant subzero temperature, the presence of shallow, cooled materials is to be expected (trough, deepwater part of the shelf). In the predominant parts of the shelf which have been periodically uplifted above sea level and lowered below seas level (eustatic movement of the Earth's crust, raising of the level of the world's oceans?), the interaction of permafrost and cooled materials is complex. Frozen and cooled materials exist in severe climatic conditions. Depending on the period of cooling, the thickness of the zone of cooling is considerable; the thickness of permafrost corresponds to the thickness of the zone of distillation and is restricted by the depth of bedding of saline water and brines.

In the shelf region, as a result of marine abrasion (characteristic of disintegrating marine shores of continents and islands) the continental cooling zone undergoes changes in the structure of the heat-exchange (subaerial-subaqueous) at the surface; this leads to sharp increases in temperature at the surface with a mean annual temperature of  $-15$ ,  $-20^{\circ}\text{C}$ , to  $-1.8$ ,  $-1.9^{\circ}\text{C}$ , and higher and to a decrease in amplitude to zero. On this basis, when there is a small thermal inertia (absence of ice), a reduction in the thickness of the zone of deep seated cooling takes place from below and there is a warming and thawing of the upper levels of the permafrost to a depth corresponding to the new thermodynamic conditions and the isolated thermal resistivity of the permafrost. Parallel to the thawing of porous and fissured icy materials, there is a diffuse dislocation of marine thaw water.

Within the confines of the shelf, on the basis of the paleogeographical and geocryological phenomena, there are assumed to be complex combinations of present day and relic permafrost with horizons (layers) of earth materials exhibiting primary and secondary cooling (in regions of recent erosion, this is thick low temperature permafrost similar to that of the adjoining areas of the continent (islands); permafrost which has horizons of relic, cooled materials at the base; permafrost which has not undergone thawing from above with the accompanying substitution of cooled water; layer of cooled materials formed as a result of cooling by marine waters, etc.



The southern polar region of frozen ground features is analogous with the northern region. The differences lie in a number of causes and conditions.

The southern region is characterized by the polar location of a continent covered with a thick ice cover, which has an absolute altitude of up to 4000 m. In the northern region the polar location is occupied by an ocean containing perennial ice; the islands and their archipelagos have small ice caps; Greenland possesses the largest ice sheet.

The southern region comprises parts of three oceans within the limits of which are found all the zonal boundaries of frozen ground features; it is characterized by its great oceanicity. The northern region is predominantly land; this constitutes a second important difference with regard to the northern region.

The southern circumpolar region has the following boundaries: within the oceans - the boundary of seasonal cooling of the troposphere and the surface layer of water, and of calving of icebergs (to 56 - 42°S); seasonal ice formation and perennial deep cooling outlining the continent; on land outside the Antarctic continent, - boundaries of seasonal freezing of earth materials and cooling of the troposphere, which in principle, coincide with the boundary of perennial cooling of ocean waters. Tierra del Fuego, the Falkland Islands and Kerguelen and Heard Islands in the Indian Ocean, etc., lie within the permafrost region.

Outside the limits of the southern region, seasonal freezing of earth materials takes place in southern South America, in Australia, in southern Africa (in the Drakensberg); there is perennial freezing in the Cordilleras and in the mountains of New Zealand.

In the southern region, the main part of the permafrost area coincides with the boundaries of the ice cover, and is dependent on the latter (its thickness, temperature in the base). In the extreme zone of the ice cover of the arctic continent, and probably beneath the central area, considering that the mean annual temperature of the ice surface is (about

-59°C), the permafrost is a continuation of the ice cover. The development of these frozen ground features occurred under variable thermodynamic conditions. The development of the ice cover caused the upward displacement of the zone of annual temperature fluctuation, which could have restricted the perennial freezing of earth materials, at the same time, it was responsible for a lowering of the mean annual temperature of the ice.

From the above, it follows that the southern circumpolar region of frozen ground features, despite the presence of a unity of structure, differs substantially from that of the northern region by distribution of its frozen ground features. Many of those which are typical of the northern region have no place in the southern region; others are restricted, and a third group prevails in accordance with the environmental features of the region.

#### REFERENCES

- BARANOV, I.Ya. "Vechnaya merzlota", ee vozniknovenie v khode evolyutsii Zemli kak planety. ("Permafrost", its occurrence during the evolution of the planet, Earth). - *Astronomicheskii zhurnal*, vol. 4, No. 4, pp. 846-853, 1966.
- BARANOV, I.Ya. Voprosy kriologii. (Problems of cryology). - II. Mezhdunar. konf. po merzlotovedeniyu. Dokl. i soobshch. vyp. 1. (Proc. of the International Permafrost Conference Papers and Communications. No. 1) Yakutsk, pp. 3-11, 1973.
- VERNADSKII, V.I. Ob oblastiakh okhlazhdeniya zemnoi kory. (Regions of cooling in the Earth's crusts). *Izbrannye trudy*. (Selected Works), Vol. 4, Bk. 2. M., Izd-vo AN SSSR, pp. 637-649, 1960.
- DOBROVOL'SKII, A. Istoriya prirodngo l'da. (History of Environmental Ice). Varshava, p. 191, 1923.



MORE PRECISE POSITION OF THE SOUTHERN PERMAFROST BOUNDARY  
BETWEEN THE URALS AND THE OB RIVER

G.I. Dubikov

Industrial and Research Institute of Engineering Surveys  
in Construction, Moscow, U.S.S.R.

Massive permafrost was encountered 150 - 200 km south of the generally acknowledged permafrost boundary for the first time, when service routes were being selected on the vast terrain between the Urals and the Ob. As a result, special research has been undertaken which has allowed us to modify existing views on the southern permafrost boundary, and also to reveal the patterns in its formation, distribution and structure.

The map (Figure 1) shows the evolution of views and propositions concerning the position of the southern permafrost boundary in this terrain during the last 20 years. A.I. Popov (1953) was the first to assign separate southern boundaries for mineral and organic (peat) permafrost.

Popov pointed out the island character of permafrost near the southern boundary and the coincidence of its distribution with that of peat frost mounds; he noted that the permafrost was shallow, with negative temperatures near 0°C, and also that there were indisputable signs of permafrost degradation. Moreover, Popov acknowledged that there may be individual permafrost islands south of the boundary he had drawn. On the basis of new data, all of the following: Baranov, 1955; Kunitsyn, 1958; Lur'e, Polyakov, 1966; Baulin et al., 1967; Shpolyanskaya, 1971; Belopukhova, 1972 corrected the position of the southern boundary on this terrain, and in all cases a more southerly position was attributed to the permafrost peatlands. Our proposed variant is similarly based on new factual material

Figure 1

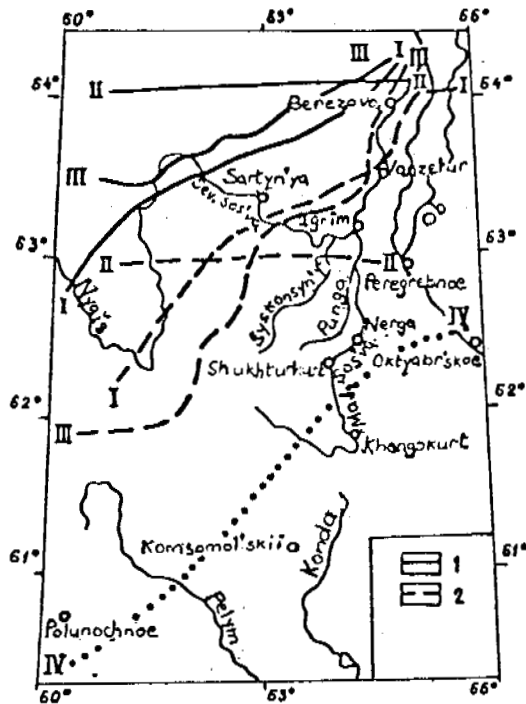

Map of the position of southern mineral (1) and organic (2) permafrost boundaries between the Urals and the Ob:  
I - according to L.F. Kunitsyn  
II - according to E.B. Belopukhova;  
III - according to A.I. Popov and N.A. Shpolyanskaya;  
IV - boundary proposed by the author.

and on direct observations made during the large scale permafrost research conducted between the Urals and the Ob. As the southern boundary is both a physical and a geographical boundary, it reflects the distribution of large permafrost islands and massifs, which formed in the Late Holocene. The position of the boundary on the map has changed significantly: it has moved latitudinally  $1\frac{1}{2} - 2^{\circ}$  farther south than was ever proposed earlier. From the settlement of Polunochnoe, the southern boundary crosses the upper reaches of the Pelym River, the source of the Konda and Malaya Sos'va rivers, and veers towards the Ob just to the north of the settlement of Oktyabr'skoe. During the last few years, there have also been discoveries of large permafrost massifs and islands on the West Siberian Lowland, considerably farther south than their generally accepted boundary. When the Samotlor deposit was developed, their existence in the northwest limb of the structure between Lake Samotlor and the Vatsinskii-Ergan River was established. Members of the

Second Hydrogeological Directorate's expedition mapped the permafrost of the latitudinal segment of the Ob which lies in the basin of the Bol. Yugan River; the permafrost is several metres thick.

The pinpointing of such a precise position for the southern boundary is in itself of great importance from both a pragmatic and a scientific point of view: for the planning and the technical and economic justification of construction sites; in the selection of rational methods and technical resources for exploration; for construction methods and environmental protection measures.

A clearly defined regularity in permafrost formation has been established for the region between the Urals and the Ob. It is encountered exclusively in forested, drained areas surrounded by swamps and lakes, mainly in river valleys on high flood plains and the terraces above these plains. Moreover, permafrost is confined to individual groups of frost mounds or to hilly terrain and is concentrated in dense, dark coniferous cedar, and fir-cedar or mixed forests with suglinok\* or peaty soils. In poorly drained and swampy forest stands permafrost degradation can be observed. Its protective covering is found to a depth of 3 - 5 m from the surface. After they have been studied in place, permafrost areas can easily be interpreted on large scale aerial photographs because of their darker background (densest forest) and hilly terrain.

Permafrost sometimes occupies such a considerable area in these latitudes that it cannot be ignored when developing a region, i.e., when routing utility corridors. For example, where pipelines intersect the high floodplains of the Malaya Sos'va and Koly-Khulyum rivers permafrost occupies 30 - 35% of the route; for the floodplains of the Pelym River it is approximately 10 - 15%, and for the first terrace above the flood plain of the Pungi River it is about 25 - 35% (Figure 2). The depth of permafrost varies from a few metres to 20 metres, increasing proportionately to the size of the frozen massif. The mean annual temperature of permafrost varies from

---

\* Suglinok - clayey silt with some sand, clayey silty loam (Transl.).

0° to -0.5°C; the lowest temperatures are observed in peat frost mounds covered by trees where the surface is subjected to the greatest amount of shade and has a thick ground cover of moss.

Figure 2

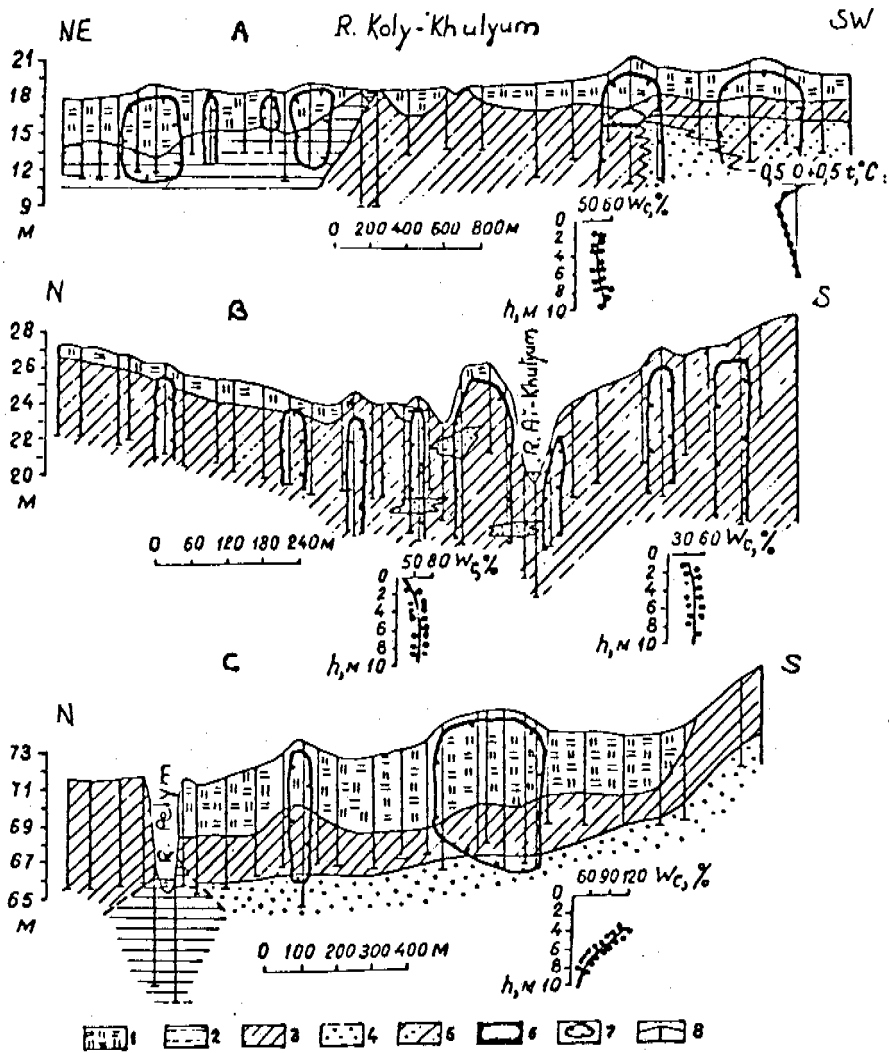

Permafrost-lithological sections and diagrams of distribution of total moisture and temperature of permafrost:

- A - on the high floodplain of the Koly-Khulyum and Malaya Sos'va rivers (at their confluence);
- B - of the first terrace above the floodplain of the Punga River (near the settlement of Svetlyi);
- C - of the high floodplain of the Pelym River (near the settlement of Pelym, 61°N);
- 1 - peat; 2 - clay; 3 - suglinok; 4 - sand;
- 5 - intercalation of sand and suglinok; 6 - ice;
- 7 - permafrost boundary; 8 - borehole.

The cause of permafrost formation in these latitudes lies in the peculiar combination of many general and local conditions, of which we list the most important: 1) negative mean annual air temperature over a period of years in the following settlements:  $-2.6^{\circ}$  in Igrim;  $-3.2^{\circ}$  in Oktyabr'skoe;  $-2.7^{\circ}$  in Sartyn'ya;  $-2.4^{\circ}$  in Khongokurt; and  $-1.8^{\circ}$  in Shukhturkurt. 2) soils, clayey and peat composition, and high moisture content in the upper horizon lowering the temperature of the earth materials owing to differences in their thermophysical properties in the frozen and thawed states; 3) dense, dark, coniferous forests and brush, shading the ground surface and lowering the surface temperature to that of the layer of air directly above the ground (approximately by  $2.0^{\circ} - 3.0^{\circ}$ ); 4) moss-lichen ground-cover up to 30 cm thick, cooling the ground by  $2^{\circ}$  in dark, coniferous forests (Chernyad'ev, 1970). The retardation of snow melt in dense forests after positive air temperatures have returned is of indisputable importance. As the rough calculations of S. Yu. Parmuzin indicate, the delay of about  $1\frac{1}{2}$  months in the melting of snow lowers the mean annual temperature of the ground surface by  $0.5^{\circ} - 1.0^{\circ}\text{C}$ .

The above listed factors which, in most instances determine the conditions for summer thawing of the ground surface, neutralize the warming influence of the snow cover on the earth materials (up to  $3^{\circ} - 4^{\circ}$ ). The depth of the snow cover during the two-year period of steady observation was from 30 - 40 cm. These factors neutralize the warming influence of snow to a significantly higher degree in drained areas consisting of clayey materials or peat, where heat circulation is considerably less than in swampy areas. Moreover, the presence of moss ground cover is not always essential for the existence of permafrost in clayey soils near its southern boundary. Thus, along the streams and small valleys on the gentle terrace slopes in the dense (crowns 0.7 - 0.8) fir and fir-birch forests without moss ground cover or shrub in their interior, permafrost is at a depth of 1.0 - 1.5 m.

Permafrost developed in the region under observation lies in the Upper Pleistocene and Holocene alluvial and organic deposits; among these, peat, suglinok and clays are widely distributed, occasionally underlain with sands. This is illustrated in the permafrost-lithological section of the floodplain of the Mal. Sos'va, Koly-Khylyum and Pelym rivers and of the



first terrace of the flood plain of the Punga River (Figure 2). Peat is found virtually everywhere on the flood plains: it reaches a thickness of 5 - 6 m. Peat is heavily ice saturated; the total amount of moisture in frozen peat varies with the area, within the range of 550 - 1000%. On the terraces within the permafrost area, peat is much less abundant; its thickness is only 1.5 - 2.0 m and the ice content is considerably less; peat frost mounds are the exception.

Clays and suglinoks are highly ice saturated. At times, ice inclusions of various dimensions form complex combinations in the cryogenic structure of the section. Stratified and stratified-reticulate structures without distinct ice lens boundaries are characteristic: in the upper part of the section of suglinok, dense, fine lenses predominate; in the middle, thick lenses predominate and in the bottom part there are a few fine lenses and porphyreous structures, although, even in this instance, the earth materials have a high moisture content. However, such a distribution of structure in frozen suglinok and clay does not always hold true. Occasionally lenses of large crystal ice 1 - 2 m thick are found in sections of clayey deposits.

Wide distribution of permafrost with a high ice (moisture) content is determined by changes in the properties of the earth materials, their epigenetic freezing and moisture migration. This ensues from the analysis of frozen clayey sections of flood plain facies in which the anisotropy is established for the distribution of total moisture along the strike and throughout the depth of the whole frozen massif (Table). A uniform variation in the spatial distribution of total moisture in permafrost is noted for the upper (to a depth of 3.0 m) and for the lower (interval of depth 8.0 - 10.5 m) horizons: the variation coefficient is up to 30%. In other words, the cryogenic texture and the distribution of moisture in the upper and lower parts of the frozen massif are characterized by their uniformity. The maximum quantity of ice is concentrated in the middle of the permafrost horizon (interval of depth 3.0 - 8.0 m); the arithmetical mean of moisture varies within the range of 70 - 100%. In this case, the variability in the spatial distribution of total moisture in this horizon is non-uniform: the coefficient of variation is more than 30% (up to 50 - 60%). The high ice

TABLE

The distribution of total moisture in the permafrost of clayey materials in the floodplains of the Malaya Sos'va and Pelym rivers and of the first and second terraces of the Punga River (based on 43 boreholes).

Depth, m	Arithmetical mean	Number of individual tests	Standard deviation of individual tests from the arithmetical mean	Variation coefficient or deviation from the arithmetical mean
1.0	39.1	9	12	30
1.5	36.2	12	9	25
2.0	51.6	21	15	29
2.5	62.7	14	16	25
3.0	69.0	23	26	38
3.5	75.1	20	27	36
4.0	81.9	30	54	66
4.5	101.4	22	60	58
5.0	80.3	24	42	52
5.5	80.5	20	34	42
6.0	79.9	24	35	44
6.5	80.9	16	37	46
7.0	70.9	23	38	54
7.5	80.6	13	39	49
8.0	77.7	14	32	41
8.5	72.8	8	22	30
9.0	69.7	9	20	29
9.5	87.6	6	27	30
10.0	58.0	7	17	28
10.5	53.0	5	11	20

content of clayey alluvial deposits of the floodplain facies can be traced through the sections from all boreholes throughout the depth of the frozen massif (independent of its thickness) and along the strike. For example, on the first terrace of the Punga River, the arithmetical mean for total moisture of frozen clayey materials for the 10 m layer over a distance of 20 km, varies from place to place within the range of 40 - 80%. Moreover, the repetition of the moisture value 50 - 70% is ascertained in approximately 60% of all calculations (Figure 3).

In the literature on the transformation of sedimentary rocks, evidence is given of water saturation in clayey materials in the vertical section. According to the research of B. Fillinius present-day, plastic

Figure 3

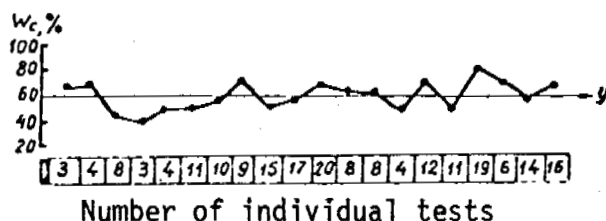

Spatial change of the arithmetical mean of total moisture for the 10 m layer of frozen sугlinok on the first terrace of the Punga River (distance covered - 20 km).

marine clays with a high water saturation have been found in "laidas"\* in Sweden: in the upper 20 m layer, the clays are in a fluid state and their moisture content varies within the range of 80 - 100%; in the 20 - 30 m interval, the moisture content decreases to 60 - 70%; and lower, at a depth of 30 - 40 m, it increases to 35 - 50%. According to the data of I.V. Savel'ev presented in the paper by L.B. Ruchin (1969) the thickness of the saturated layer of viscous silts and clays along the coastline of the Black Sea is about 6 - 7 m. There the moisture content of the sediments decreases with depth from 170 to 75% and consistently remains within their flow limits. This information can help in clarifying the reasons for the formation of ice-saturated horizons in clayey materials during freezing. In our case, the high ice saturation of clayey materials of the flood-plain facies could be due to the fact that they were particularly water-saturated to a great depth when they became perennially frozen, as a result of the general swampiness and the peat content of the surrounding terrain.

The above analysis of geological and geographical factors determining the thermal conditions of the permafrost is convincing evidence that a change in any of these processes of natural or contrived development would lead to disturbance of the permafrost conditions, that is, thawing of permafrost or permafrost formation. Owing to the high temperature of permafrost, disturbance of the ground cover on this terrain serves as an impetus for permafrost thawing and thermokarst formation. The calculations of V.P. Chernyad'ev (1970) show that under the conditions of natural snowfall, removal of the moss cover brings about the thawing of permafrost to

---

\*"laida" - low lying coastal areas bordering the northern seas; usually swampy with hummocky relief, permafrost often close to the surface; flooded during high tides.

a depth of 4.8 m in 8 years; when the area has been completely free of snow for 20 years, permafrost forms to a depth of 7 - 8 m. Field research supports these calculations. In natural circumstances, the processes of permafrost formation and thawing would then be repeated as a result of the dynamics of vegetative cover, of the change in the moisture content of the materials and of short term fluctuations in climate. The established features of permafrost formation allow forecasting of their changes in the course of normal and contrived change in the natural factors.

When land is developed, it is the vegetative cover (felling of trees and clearance of shrub), the snow cover and the moisture content of the earth materials which are first affected. These disturbances change the existing conditions of heat exchange between the ground and the atmosphere and create a new thermal regime. This is first reflected in the dynamics of the layer of seasonal thawing and freezing. For example, during the period 1964 - 1972 where, on the terraces above the Punga River, the trees had been felled in the dark coniferous forest and the moss-lichen ground cover had either been interrupted or totally destroyed, the amount of solar radiation penetrating the ground increased, perennial thawing began, and the protective covering over the permafrost settled 2.5 - 4.2 m in suglinoks and 2.0 - 2.6 m in peats (without the formation of thermokarst lakes). During this period, the combined influence of the disturbance of the surface condition and the presence of the gas pipeline caused permafrost thawing to a depth of 5.0 - 6.5 m. Since permafrost which starts at a depth of 2 - 3 m is characterized by a high ice content, thawing is usually accompanied by surface subsidence, and, when the water cannot drain away, by the formation of thermokarst lakes.

### Conclusion

1. A new variant has been established for the southern permafrost boundary: between the Urals and the Ob it is moved latitudinally  $1\frac{1}{2}$  -  $2^0$  farther south than previous variants.
2. Permafrost formation in these latitudes is determined by a combination of many conditions, of which, the main factor is

insufficient summer warming of the earth materials in shady forests.

3. Observed regularities allow the creation of a special zone of massive and island permafrost in clayey and organic materials, which are restricted exclusively to dense coniferous forests.
4. The permafrost of this zone is characterized by an extremely unstable thermal regime and high ice content. On the basis of ice content, it is comparable with syngenetic frozen deposits.

#### REFERENCES

- BARANOV, I. Ya. 1955. Yuzhnaya granitsa oblasti rasprostraneniya mnogoletnemerzlykh porod.-V kn.: Materialy k osnovam ucheniya o merzlykh zonakh zemnoi kory, Moscow, Izd-vo AN SSSR, No. 2, pp. 38-44.
- BAULIN, V.V., DUBIKOV, G.I., BELOPUKHOVA, E.B., SHMELEV, L.M. 1967. Geokriologicheskie usloviya Zapadno-Sibirskoi nizmennosti. Moscow, "Nauka" p. 212.
- BELOPUKHOVA, E.B. 1972. Osobennosti rasprostraneniya mnogoletnemerzlykh porod v Zapadnoi Sibiri. - Trudy PNIIS, t. 18, Moscow, pp. 94-99.
- KUNITSYN, L.F. 1958. mnogoletnyaya merzlota i svyazannye s nei formy rel'efa na severo-zapade Zapadno-Sibirskoi nizmennosti. - "Voprosy fizicheskoi geografii". Moscow, pp. 312-337.
- LUR'E, I.V., POLYAKOV, S.S. 1966. K voprosu o yuzhnoi granitse rasprostraneniya mnogoletnemerzlykh porod v zapadnoi Sibiri. - "Merzlotnye issledovaniya", No. 6, Izd-vo MGU, pp. 155-159.
- POPOV, A.I. 1953. Vechnaya merzlota Zapadnoi Sibiri. Moscow, Izd-vo AN SSSR, p. 230.
- RUKHIN, L.B. 1969. Osnovy Litologii. M., "Nedra", p. 704.
- CHERNYAD'EV, V.P. 1970. Issledovaniya dinamiki sezonogo i mnogoletnego promerzaniya-protaivaniya v usloviyakh Zapadnoi Sibiri. - Trudy PNIIS, t. P, Moscow, pp. 6-91.
- SHPOLYANSKAYA, N.A. 1971. Osnovnye zakonomernosti rasprostraneniya vechnoi merzloty i etapy ee razvitiya - V kn.: Prirodnye usloviya Zapadnoi Sibiri, No. 1, Izd-vo MGU, pp. 102-123.

## PERMAFROST IN THE MOUNTAINS OF CENTRAL ASIA

A.P. Gorbunov

Permafrost Institute, Yakutsk, U.S.S.R.

Permafrost in the mountains of Central Asia covers approximately 1 million km<sup>2</sup>. The main permafrost bodies are widespread in Tibet, Kunlun, Tien-Shan, Pamir-Alai, Hindu Kush, Karakorum, Nien-Shan, in the Himalayas and the Sino-Tibetan mountains. In the far north of the region, in the northern ranges of Tien-Shan, at approximately 43°N, the altitudinal boundary of permafrost islands coincides with the 2700 m contour; to the far south, in the Himalayas and in the Everest region, at approximately 28°N, this boundary extends upwards to the 4900 - 5000 m level (Fujii, Higuchi, 1976).

In Tien-Shan and Pamir-Alai (within the boundaries of the U.S.S.R.) permafrost occurs over an area of approximately 110,000 km<sup>2</sup>.

Present knowledge concerning the permafrost of Tien-Shan and Pamir-Alai allows us to establish the altitudinal boundaries of the sporadic, island, discontinuous and continuous types of permafrost distribution. The following criteria are proposed for establishing the above categories. The lower boundary of sporadic distribution of frozen ground is determined by the presence of permafrost bodies in coarse, granular talus and scree. The lower boundary of island permafrost is determined by the occurrence of frozen ground on steep northern slopes of more than 30°. The lower boundary of discontinuous permafrost is determined by the presence of permafrost on all slopes, except those with a southern aspect. Within the zone of discontinuous permafrost, open taliks are widely developed in detrital fans, along the beds and flood channels of mountain rivers. The lower boundary of continuous permafrost, including south facing slopes, reflects the general

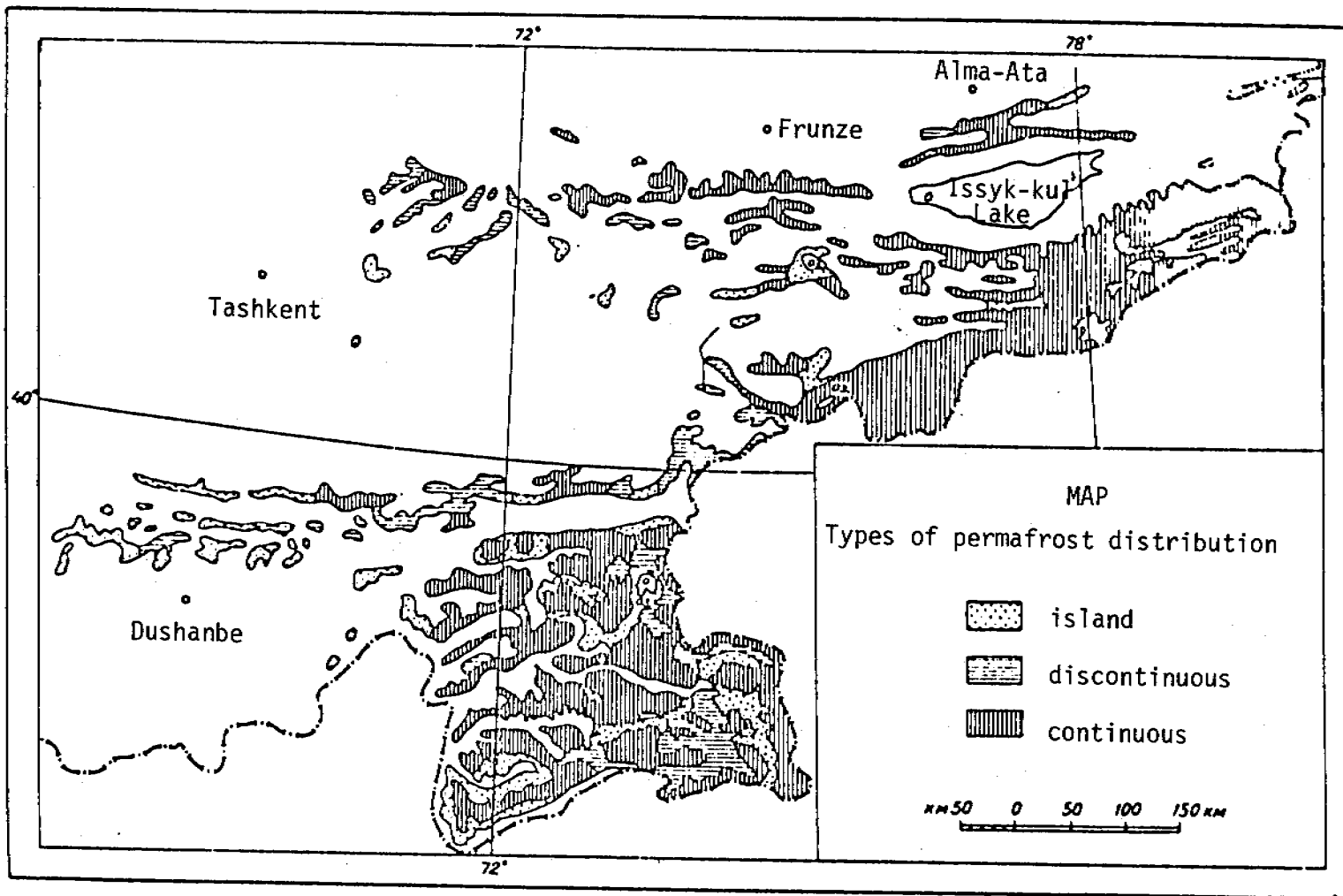

Map of permafrost distribution in the mountains of Central Asia

development of the frozen ground. Within this zone, open taliks may exist along water penetrated tectonic faults, under deep lakes and large valley glaciers.

The altitudinal boundaries of the permafrost types found in Tien-Shan and Pamir-Alai are set out in Table I and their distribution is shown on the map (see Figure).

TABLE I  
Distribution of permafrost with altitude

Type of permafrost distribution	Absolute altitude of lower boundaries of distribution types, m		Percentage of total permafrost, %
	Northern Tien-Shan	South-West. Pamir	
Sporadic	2200	3200	Less than 5
Island	2700	3700	5 - 30
Discontinuous	3200	4100	30 - 70
Continuous	3500	4400	More than 70

The special circumstances of seasonal and perennial freezing can be observed in the coarse granular talus and screes. Talus containing no filler silt is subject to very deep seasonal freezing when there is a thin, unstable snow cover. For example, in northern Tien-Shan, even at an altitude of 1600 m above sea level, where the mean annual air temperature is 5 - 6°C, seasonal freezing of talus rarely reaches 3 m, whereas in suglinok-detrital\* soils on the same slopes, seasonal freezing never exceeds a few tens of centimetres. This is related to the fact that in winter, in the mountains in the latitudes under observation, there is a high degree of insolation. Therefore, the snow on east and west facing talus is unstable. Water from melting snow infiltrates talus and freezes, filling the voids with ice between the fragments. This in turn, sharply increases the thermal conductivity of the medium, so that "air" talus becomes transformed into

\* Suglinok - clayey silt with some sand, clayey silty loam (Transl.).



"ice" talus. The former, on account of its thermophysical properties is closer to air, the latter to ice. Moreover, the more voids that become filled with ice the truer is the comparison.

The ice content of talus is determined by a number of factors, the most important of which is the snow regime covering the talus. Frequent light snowfalls alternate with ground thaw. The thawing leads to partial or complete disappearance of snow from the talus. The snowfalls greatly favour the saturation of talus by ice formed by seepage. This sharply increases the thermal conductivity of the talus, so that it in turn predetermines the possibility of yet deeper freezing. In spring and summer the opposite situation can be observed: surface thaw of talus and the disappearance of ice from the voids, form  $b_a$  surface layer with an extremely low thermal conductivity which protects the underlying ice horizon from seasonal thawing. Moreover, colder but consequently denser air remains in the voids in the summer, impeding the thawing of the talus. Therefore, permafrost frequently forms in this type of talus above certain absolute altitudes (i.e., above 2200 m in Tien-Shan). It has been established that it can form and exist for several years, when the mean annual air temperature is  $3 - 4^{\circ}\text{C}$  and the mean monthly air index is  $60^{\circ}\text{C}$  or less.

In contrast, the formation of a thick, stable snow cover helps to protect talus from deep seasonal freezing, even at considerable altitudes where the mean annual air temperature is  $-3^{\circ}\text{C}$  or colder. Such a situation for example, can be observed in the Gissar Range (Maikhur Valley and the Varzob Basin) where at an altitude of 3600 m the coarse granular talus on the northern slope freezes to no more than 2 - 3 m.

Recently, data on thickness and temperature of permafrost at various points in the region began to appear. This has made it possible to estimate changes in the values with altitude (Table II).

It should be mentioned at this point that, within the distribution limits of unconsolidated granular materials, the thickness of the permafrost layer does not exceed 200 m in Tien-Shan and 150 m in the Pamir, and the temperature of frozen ground at a depth of zero amplitude does not exceed

TABLE II

Estimate of temperature (I) and thickness (II) of permafrost in Tien-Shan and Pamir-Alai

Absolute altitude, m	Northern Tien-Shan		South-Eastern Pamir	
	I, °C	II, m	I, °C	II, m
3000	0 - -1	0 - 50	-	-
4000	-5	200	0 - -1	0 - 50
5000	-11	400	-7	300
6000	-	-	-13	800
7000	-	-	-19	more than 800

-5°C in the former and -3°C in the latter region. High values for the thickness and temperature of permafrost are characteristic of solid rocks only.

Permafrost in unconsolidated granular materials is developed mainly at the watersheds of Inner Tien-Shan and on the plateaus of Eastern Pamir where they vary more in mechanical properties and in origin.

The Paleogene and Neogene - Lower Quaternary formations froze epigenetically. In the initial stages of freezing, they were compressed due to diagenesis and, in a number of cases, became sufficiently monolithic and for the most part dehydrated rock types such as conglomerates, limestones, mudstones, sandstones, etc. Dehydration was furthered by their being drawn into orogenic movements. Therefore these formations have a low ice content. The ice they contain is dispersed in the form of very fine crystals. The most compressed rocks contain virtually no ice.

Middle Pleistocene strata are found mainly in fluvio-glacial and moraine deposits and are rare within the permafrost zone. There are no data concerning their cryogenic texture and therefore it is not possible to assess the type of permafrost.

The freezing of the moraine layers of the Upper Pleistocene and Holocene epochs took place under very specific conditions, which is still the

case today. These conditions are mainly determined by an increased water content of the ground; this is associated with meltwater seepage into unconsolidated talus and with its subsequent freezing. The degree of moistening of earth materials is significantly dependent on the character of the relief. The freezing of moraines is mainly syngenetic.

The frozen lake deposits were formed in the Upper Pleistocene and Holocene epochs. These frozen deposits are usually characterized by a striated cryogenic structure, which usually follows primary stratification of the deposits. Together with the lenses of segregated ice, the thickness of which for the most part does not exceed 15 - 20 cm, lake strata contain lenses, stocks and veins of injected ice. The largest ice lenses have been found on the banks of the Karakul (Eastern Pamir) where they reach a thickness of more than 5 m and extend from 10 to 14 m.

The perennial freezing of lake sediments under the arid conditions of Inner Tien-Shan and Eastern Pamir occurred and is still occurring in a subaqueous environment on littoral shoals at a depth of up to 1 - 1.5 m. This gives rise to the very high ice content in lake deposits. Only in rare instances, when there is a rapid discharge from the lake basin, does permafrost form epigenetically in subaerial conditions. When this occurs, ice lenses form only in the upper 1 - 2 m of the permafrost. Below this, the structure of the sediment is massive with little ice content.

Owing to their considerable water content, lake sediments and the underlying deposits are susceptible to severe permafrost conditions. This is reflected in the processes of active frost heave. It is in these very deposits that perennial hydrolaccoliths and other hummocky formations occur.

On the slopes, the coarse granular talus has the highest ice content. This talus freezes both syngenetically and epigenetically. Its ice content depends on the size of the fragments, the type of filler silt, the type of seasonal thawing and freezing, and the water content. The highest ice content is found in talus with large fragments without filler "suglinok".

Porous, and less frequently, basal-massive permafrost structure is characteristic of syngenetically freezing talus deposits. An important

feature of their structure is the ice layers, which are relatively recurrent formations along the strike (to depth of 3 - 5 m and apparently still deeper). Their thickness is from 10 - 20 cm, and the distance between the layers varies within wide limits, usually from 20 - 30 cm to 1 m. The ice in the layers has no inclusions of large fragments. The presence of layers is an important indicator of the syngenetic freezing of talus.

Perennial and seasonal freezing of alpine peat bogs and swamp meadows leads to the formation of segregated and injected ice, and of hummocky complexes.

In the mountains of Central Asia, frozen bedrock occupies at least 75 - 80% of the permafrost area. In regions where the vertical and horizontal separations are particularly great (Western Pamir, the Gissar and Zavershan ranges) frozen unconsolidated materials are virtually non-existent.

Frozen bedrock must be divided into two categories: frozen and chilled. The former contain ice, the latter do not, despite the negative temperatures of the rocks themselves. This is related to the fact that some rocks, either owing to their monolithic nature, or for some other reasons, contained no water at the moment of freezing.

Frozen and chilled rocks can alternate even within a petrographically homogeneous massif. Therefore, at the present time, it is impossible to estimate even approximately the correlation between the volume of frozen and chilled bedrock.

In bedrock, ice is usually concentrated along fissures which are of diverse but mainly tectonic origin. Usually, the thickness of fissure ice varies from a few millimetres to 20 - 30 cm. The layering of ice veins, the absence of strong parallelism in the layers, compression of air cavities, are all evidence of repeated ice flowage and of the freezing of water in closed systems. Apparently, it continued with the shift of solid blocks along tectonic faults.

The depth of seasonal thawing decreases steadily with altitude. Thus in Northern Tien-Shan, in the altitude range of 3100 m - 4100 m, the

thickness of the seasonally thawed (active) layer decreases to approximately 20 cm for every rise of 100 m. But frequently, a change in the structure of the earth materials and exposure of the slopes has appreciably more influence on the thickness of the seasonally thawed layer, than does a rise of several hundred metres. Owing to the fact that earth materials in the snow belt are very homogeneous, the thickness of the seasonal layer is characterized in this region by its stability with identical exposure and altitude. Within the alpine zone, where the texture of earth materials varies greatly, the depth of seasonal thaw can change sharply over a small distance.

Minimum depth of the seasonal layer (30 - 40 cm) is observed in peatlands and lake silts, which are both enriched by organic materials. The maximum thickness is in gravels and detrital deposits (450 - 500 cm).

The wedging out of the seasonally thawed layer above 4500 - 5500 m is a feature of the region's high mountains, where earth materials thaw to a depth of a few centimetres during the day and freeze completely at night. At altitudes of more than 6600 - 6500 m on steep northern slopes, there is, as a rule, no daytime thawing of solid or talus surfaces.

Steady thawing of seasonally thawed layers begins in May and reaches its peak in September. In Tien-Shan freezing of a 1 m thick layer at an altitude of more than 3600 m is completed in the first ten days of October; for a layer 2.5 - 3 m in thickness at an altitude of approximately 3200 m it begins in December and lasts through the beginning of January. Seasonal thawing proceeds 2 - 4 times more slowly than freezing.

Formation of diverse forms of permafrost terrain in alpine regions is associated with perennial and seasonal freezing. Maximum concentration of permafrost terrain forms is observed within the alpine zone. This is brought about by permafrost, deep seasonal freezing, frequent transitions of surface temperatures through 0°C and relatively wide distribution of fine-grained earth materials which must become sufficiently moist. Above and below the alpine zone, the number and variety of permafrost terrain forms diminishes.

Most types of cryogenic terrain including solifluction features, patterned ground and icings are not a reliable indication of permafrost.

Thermokarst subsidence in lake deposits, hydrolaccoliths and rock glaciers are genetically related to permafrost.

Permafrost processes play an important role in the evolution of glacial moraines, alpine rock glaciers and mudflows.

In present day moraines, formation of large masses of secondary ice is taking place. This is connected with the freezing of melt water in permafrost. The melting of primary and secondary ice and its forward movement due to ice flowage leads to moraine deformation (cave-ins, fissuring, etc.).

Rock glaciers are permafrost-glacial forms; their genesis and development is possible within a permafrost zone. Injected ice plays the dominant role in their formation, for it fills the large voids between rock fragments. Plastic deformation of the ice is responsible for the movement of rock glaciers. Rock glaciers, despite their external similarities with moraines, differ from the latter in their internal structure and their surface microrelief. Two generations of rock glaciers have been discovered in Tien-Shan: ancient (inactive) and present-day (active) types.

The foci of glacial mudflows originate in the talik zones and lakes of present day moraines. Taliks and rapid lake discharges result from the upward migration of glacier water into frozen moraine deposits. The possible volume of a mudflow is restricted by the volume of the unfrozen ground and the capacity of the thermokarst and other moraine lakes.

Formation of permafrost in Tien-Shan and Pamir-Alai is inextricably associated with the tectonic development of mountain regions, with a general cooling, with increasing aridity and with a strengthening of the continental climate in the Neogene-Quaternary period. Analysis of data on the development of the ancient glaciation in the mountains of Central Asia, of the occurrence of relic permafrost, on cryoturbations and remnant permafrost structures, allows us to form a general picture of the evolution of permafrost in Tien-Shan and Pamir-Alai. The first permafrost masses could have appeared in the Pleistocene Epoch in the upper altitudes of Central

Tien-Shan and Pamir. Since the climate in the Pleistocene and the Lower Pleistocene was less continental and there was essentially less precipitation than at present, permafrost formed at the snowline, i.e., exclusively within the snowbelt. Therefore, massive freezing took place in solid rock. In the Middle Pleistocene, in connection with the evolution of the continental climate, it became possible for terrain lying below the snowline to freeze. This gave rise to the first expanses of frozen unconsolidated granular material. According to preliminary estimates, the lowering of the permafrost boundary in the Middle and Upper Pleistocene, when compared with the present-day position, was no less than 1000 m.

Permafrost conditions in the mountains of Central Asia vary considerably from place to place. Differences in the morphology of the permafrost, its temperature conditions and its material composition, give grounds for dividing the mountains of Central Asia into 7 permafrost (geocryological) provinces: 1) Northern Tien-Shan, 2) Western Tien-Shan, 3) Inner Tien-Shan, 4) Alai, 5) Gissaro-Turkestan, 6) Western Pamir, 7) Eastern Pamir.

The Northern Tien-Shan province includes Zailiiskii and Kungei Alatai, Ketmen, most of the northern slopes of the Kirgiz Range and the northern slope of Eastern Terskii Alatai. The province's snowline lies at 400 - 1000 m above the permafrost boundary. The area of glaciation is approximately 1600 km<sup>2</sup>; the permafrost area is 9000 km<sup>2</sup>. This is 30.2% of the glaciated area and 15.7% of the permafrost area of the whole of Tien-Shan. As for the Quarternary formations of unconsolidated deposits in valleys and depressions, they occupy no less than 20% of the area of the permafrost zone. In this region, continuous permafrost prevails. The depth of the permafrost is from 0 to 400 m, its temperature is from 0° to -10°C.

Western Tien-Shan province comprises Western Tien-Shan. The snowline coincides with or is higher than the permafrost boundary by no more than 400 m. The glaciated area is approximately 1600 km<sup>2</sup>, that of the permafrost is 3450 km<sup>2</sup>. Accordingly, this is 9.4% of the glaciated and 6.1% of the permafrost area of Tien-Shan. Metamorphic and carbonate formations are the most common. Frozen Quaternary deposits are not represented.

Present day terminal moraines are mainly unfrozen. In this province, island and discontinuous permafrost are dominant. Permafrost is from 0 to 250 - 300 m thick, the temperature from 0° to -7°C.

Inner Tien-Shan province consists basically of Tien-Shan. The snowline at 700 - 1800 m is higher than the boundary of the permafrost zone. The area of present day glaciation is approximately 3200 km<sup>2</sup>, and the area of permafrost is 44,900 km<sup>2</sup>. This accordingly comprises 60.4% of the glaciated and 78.2% of the permafrost area of Tien-Shan. Magmatic, metamorphic and carbonate formations have roughly the same distribution. Quaternary formation of frozen unconsolidated earth materials in the valleys and depressions occupies at least 35% of the permafrost province. In this area continuous permafrost prevails. The thickness of the permafrost zone is from 0 to 800 m or more, its temperature is 0° to -20° - 25°C.

Alai Province covers the Alai Range from the upper reaches of the Tar River to the upper reaches of the Soch River. On the average, the snowline in the area is at 1000 m above the permafrost boundary. The area of glaciation is about 700 km<sup>2</sup>, that of the permafrost 7000 km<sup>2</sup>. This is 6.5% of the glaciated and 11.4% of the permafrost area of Pamir-Alai. Quaternary deposits are relatively widely distributed in this area and are represented mainly in present day and Upper Pleistocene moraines and rock glaciers. Discontinuous permafrost is predominant. The depth of permafrost within the boundaries of this province reaches 300 - 350 m; its temperature ranges from -7° to -9°C.

Gissaro-Turkestan province includes the Turkestan, Zavershan, Gissar and Karategin ranges. Here the snowline coincides with or is higher than the permafrost boundary. The area of present day glaciation is 1147 km<sup>2</sup>, the permafrost area is 5400 km<sup>2</sup>. This correspondingly comprises 10.5% of the glaciated area and 8.3% of the permafrost area of Pamir-Alai. There are no Quaternary deposits in this area; island permafrost predominates. Permafrost in the high altitudes reaches a thickness of 350 - 400 m and its temperature goes down to -10°C.

Western Pamir province includes the following main ranges: Petr Pervyi, Darvaz, Vanch, Yazgulem, Ryshan, Shugnan, Shachdar, Akademii Nauk,



Tanymas and Beleuli. The snowline coincides with or is no more than 400 m above the permafrost boundary. The area of present day glaciation is approximately 7300 km<sup>2</sup>, that of the permafrost 19,700 km<sup>2</sup>. This is 66.6% of the glaciated area and 29.5% of the permafrost area of Pamir-Alai. As a rule, there are no frozen Quaternary formations, although there may be some small stretches in the extreme east of the province. Present day and ancient moraines are unfrozen. Continuous and island permafrost is predominant. The maximum thickness of the permafrost exceeds 800 m and its minimum temperature reaches -20°C.

Eastern Pamir province includes the Zaalai Range as far as the upper reaches of the Altyndary River in the west, Sarykol, Muzkol, Zulymort, North-Alichur, South-Alichur, and the Vakhnan ranges. The snowline lies on average at 1500 m above the permafrost boundary in the region. The area of present day glaciation is approximately 1800 km<sup>2</sup>, the permafrost area is 33,800 km<sup>2</sup>. This is 15.4% of the glaciated area and 50.8% of the permafrost area of Pamir-Alai. A wide distribution of Paleogenic, Neogenic and Quaternary frozen, unconsolidated materials, particularly lacustrine and morainic deposits, is characteristic of this province. All types of permafrost are represented to approximately the same degree. The maximum thickness of frozen, unconsolidated deposits is 150 m, the temperature goes down to -3°C. The maximum thickness of permafrost in the bedrock is 800 m or more, it has minimum temperature of -20°C.

Permafrost and the permafrost processes influence many components of alpine landscapes (subsurface and surface water, vegetation, soils, terrain, ground animals). The action of permafrost on the landscape has both negative and positive effects. The former are well known, the latter are exhibited mainly in the increased moisture content of the ground, and in the improved conditions for vegetation in the interior dry regions of Tien-Shan and Pamir.

The development of the alpine regions of Central Asia (construction, recovery of minerals, highways, power lines, communication lines and the study of mudflows) all call for further permafrost research and both small- and large-scale mapping.

REFERENCE

- FUJII, Y. and HIGUCHI, K. 1976. Ground temperature and its relation to permafrost occurrences in the Khumbu Region and Hidden Valley. Journal of Japanese Society of Snow and Ice, vol. 38, pp. 125-128.



ZONAL AND REGIONAL PATTERNS OF FORMATION OF  
THE PERMAFROST REGION IN THE U.S.S.R.

V.A. Kudryavtsev, K.A. Kondrat'eva and N.N. Romanovskii  
Moscow State University, U.S.S.R.

A permafrost region is defined as a region in which the temperature of the earth materials remains at or below  $0^{\circ}\text{C}$  for no less than three years. In order to study the main features of the permafrost region and to comprehend its fundamental patterns of formation and distribution within the U.S.S.R., geocryological regionalization is essential. This involves dividing the earth's crust into areas which reflect the conditions of formation, distribution and structure of the permafrost region. In each area, the qualitative and quantitative characteristics selected as criteria for regionalization have their own particular significance. These characteristics must be typical for the designated area, i.e., they must be predominant throughout permafrost formation and evolution. Geocryological regionalization is complex, since it must take into consideration the dependence of the criteria on geological, geomorphological, climatic, palaeographic, thermophysical and other environmental conditions. The regionalization of the permafrost zone reflects the view prevalent in permafrost studies for the period in which the general map of the permafrost region was compiled.

At this point, two fundamentally different approaches to regionalization should be pointed out.

In the first method, the demarcation of zones takes place directly on the survey maps (scale 1 : 10,000,000 or smaller) during compilation. This is done by making generalizations and by analyzing existing factual information interpreted from the standpoint adopted in local permafrost studies.

The second method involves the demarkation of zones on geocryological maps of a larger scale, with a view to generalizing factual material for a specific purpose, and to revealing regional, zonal patterns of formation in the permafrost region.

The main task of geocryological regionalization is to show the heat exchange between latitudinal and high altitude zones and the geological and geographical conditions of the region; because this furnishes a possible explanation for patterns of formation and evolution of the permafrost region. Therefore, the principles of regionalization must take into account regional and zonal patterns of formation of geocryological conditions. This can be accomplished by factor analysis. Environmental conditions influencing the evolution of the permafrost region and its present day condition are: the present day climate and the changes it underwent in the Cenozoic; formation of relief, and sedimentation in recent times; landscape conditions and changes during this period; the transformation of earth materials and groundwater; change in the level of heat exchange at the ground surface; related modifications and periodic changes in climate, etc. In connection with this, geocryological regionalization must be supported by geological, geomorphological, neotectonic, geobotanical and climatic regionalization. Such a correlation would be possible if a common zonal and regional classification system for geological and geocryological conditions in the permafrost region were established. However, to date, no full classification system has been devised, although there are detailed and generalized systems for individual aspects of the occurrence of geocryological conditions. The explanations in the legend of the geocryological map of the U.S.S.R. on the scale 1 : 2,500,000 can be considered as just such an all-regional classification system. For the very first time, this map made it possible to show patterns of formation of geocryological conditions for the whole U.S.S.R., with a view to compiling an aggregate of the basic geocryological features and environmental factors.

Regionalization maps of the permafrost region of the U.S.S.R., compiled in the first instance by the methods indicated above, were the first geocryological maps to appear in the early days of permafrost studies. The first regionalization maps, compiled by M.I. Sumgin (1927, 1937), S.G.

Parkhomenko (1937) and V.F. Tumel' (1946), were mainly permafrost distribution maps. However, as there was a very limited amount of data, these maps were actually a reflection of the latitudinal zonality of permafrost distribution.

Subsequent accumulation of factual material on the frozen region of the lithosphere, connected with the development of Siberia, the Far Eastern regions and future development of regional permafrost studies demanded the compilation of new, improved maps. Therefore, geocryological regionalization maps began to be compiled on a systematic, integrated, environmental basis, reflecting permafrost formation as the result of heat exchange in specific geographical and geological conditions.

These conditions were met by the permafrost-temperature regionalization map of V.A. Kudryavtsev (1954), compiled on the basis of: a) consideration of the close dependence of geocryological conditions and geological and geographical conditions, b) both qualitative and quantitative evaluation of these interdependencies, c) clarification of the influence of each environmental factor on the formation of the mean annual temperature of the earth materials, which links the thermophysical aspects of the cryogenic processes\* with the geological and geographical aspect. This approach made it possible to distinguish between environmental and permafrost temperature zones belonging to specific geological-geomorphological provinces and climatic-geobotanical zones, but different in distribution, mean annual temperatures and thickness of permafrost. Thus, this schematic map reflected the regional classification of permafrost and patterns of formation of geocryological conditions which later made geocryological forecasting possible. In the Department of Permafrost Studies at Moscow University, further work concerning the geocryological survey and mapping continued in this direction.

In subsequent years, a number of regionalization maps were compiled on which various combined and individual geocryological features were depicted. It should be noted that, since the permafrost region is a

---

\* cryogenic processes - physico-geological processes resulting from energy and mass exchanges in freezing, frozen and thawing earth materials (Transl.).

complex, natural system of matter, formed either syngenetically or epigenetically in specific earth materials under specific climatic and landscape conditions and developed in the Pleistocene and Holocene, each aspect of interdependence of the permafrost region and the environment demands special study and is itself both the subject of regionalization and an identifying feature. In this case, whatever aspect of interdependence is exhibited or whatever characteristics are revealed, the orientation of classification and regionalization of the permafrost region are genetic.

In 1956, P.F. Shvetsov introduced the concept of geocryological formation as the basis of geocryological regionalization. Having defined it as permafrost, typical for a given section, area, region of the earth's surface, relatively homogeneous in composition, structure, temperature, thickness, depth of occurrence, degree and type of distributional discontinuity, water bearing capability and ability to permeate the earth materials (p. 29), Shvetsov introduced a regionalization unit whose characteristics on any scale, from survey maps to plans, could only be read from a table and not from the map itself. This approach has not received wide acceptance as a principle for geocryological regionalization, for although it depicted a multiplicity of permafrost zone characteristics and patterns of formation, their connection with environmental change could not be traced. Moreover, such an approach had been employed earlier by all researchers, beginning with M.I. Sumgin, V.F. Tumel', V.K. Yanovskii, V.A. Kudryavtsev, etc. At the present time it is being employed as the basis of landscape microregionalization in geocryological surveying and is supplementary to basic geocryological regionalization. On the other hand, it is also used as the basis for generalized regionalization. Geocryological conditions delineated on the detailed map are generalized into a larger system for specific purposes such as indicating the zonal patterns of formation in the permafrost region or the connections between hydrogeological textures and the permafrost region, or for geological engineering evaluations of geological, structural subdivisions in the permafrost zones, etc.

Therefore, regionalization should be based on genetic classification so that, on the one hand, it makes it possible to trace patterns of permafrost formation, and on the other hand for regionalization

purposes, to recognize general, zonal and regional patterns of heat exchange between earth materials and the atmosphere by way of basic geological parameters.

I.Ya. Baranov, A.I. Popov, P.I. Mel'nikov, A.I. Kalabin and others, continuing in the same direction as V.A. Kudryavtsev, have developed principles for regionalization.

I.Ya. Baranov published the first geocryological map of the U.S.S.R. on the scale 1 : 10,000,000 in 1960, which generalized the factual material accumulated at that time and reflected the current views on the nature of the permafrost zone in the U.S.S.R. The map is compiled on a schematic, geological basis, with generalizations in the form of contour lines indicating "plakory"\* conditions, zonal and (to a lesser degree) regional traits of distribution, thickness and mean annual temperature of permafrost. Cryogenic and postcryogenic features are also shown in a generalized form. Moreover, there are six geocryological zones distinguished on the map and described in the text; two of these are oceanic. The features which formed the basis of the previous map are developed further on the new geocryological map of the U.S.S.R. compiled by I.Ya. Baranov in 1973 on the scale 1 : 5,000,000.

Having developed a cryolithological approach to regionalization, A.I. Popov compiled a map of permafrost-geological areas of the permafrost region of the U.S.S.R. (1958) and a permafrost map of the U.S.S.R. (1962) on the scale 1 : 20,000,000, which shows the types of ground ice. Popov has also compiled a schematic map of cryogenic earth materials of Western Siberia on the scale 1 : 5,000,000 (1959), and a number of other maps.

A considerable number of regionalization maps have been compiled for individual areas of the permafrost region of the U.S.S.R. For example, the permafrost-hydrogeological map of the North-East U.S.S.R. on the scale 1 : 10,000,000 published by A.I. Kalabin (1960); P.I. Mel'nikov's schematic geocryological map of the Yakutsk A.S.S.R. (1970), first compiled on the

---

\* Plakory - slightly undulating, well-drained interfluves (Transl.).



scale 1 : 5,000,000; a number of schematic geocryological maps of Western Siberia on the scale 1 : 10,000,000 - 1 : 5,000,000 by V.V. Baulin and co-authors (1967, 1972); a geocryological regionalization map of the U.S.S.R. on the scale 1 : 20,000,000 by I.A. Nekrasov (1970); a schematic geocryological map of Central Siberia on the scale 1 : 7,500,000 by S.M. Fotiev and co-authors (1974); and many others.

Intensive development of the permafrost region during the past decade has, on the one hand, led to the accumulation of diverse factual material and, on the other hand, to the need for scientific regionalization and the compilation of a more detailed map of the permafrost region to fill the growing needs of the economy. A whole series of general and thematic maps has been compiled for the individual regions during the past decade; their scale is 1 : 2,500,000 - 1 : 5,000,000.

The new regionalization map of the permafrost region of the U.S.S.R. represented in this paper was compiled on the scale 1 : 25,000,000 from the geocryological map of the U.S.S.R. on the scale 1 : 2,500,000 and provides a visual representation of the zonal and regional features of heat exchange within the permafrost region.

The regionalization map illustrates 3 of the region's basic traits established during analysis of zonal heat exchange characteristics under local geological and geographical conditions: 1) distribution of permafrost according to degree of discontinuity over the area and throughout its depth; 2) nature of change in level of heat exchange of earth materials, established from the typical mean annual temperatures for a given latitudinal or altitudinal zone; 3) thickness of permafrost. Patterns of formation of these characteristics were established during the mapping of geocryological conditions on the scale 1 : 2,500,000, by factor analysis. An analysis was undertaken when the following factors were being taken into account: dependence of the geocryological parameters of geological structure; historical development of the geology, hydrogeological and geothermic conditions of the Earth's interior; and integrated factors of landscape-geomorphology and surface climate. Mapping proceeded in accordance with the analysis of these factors.

# PERMAFROST IN THE U.S.S.R.

Scale 1 : 25 000 000

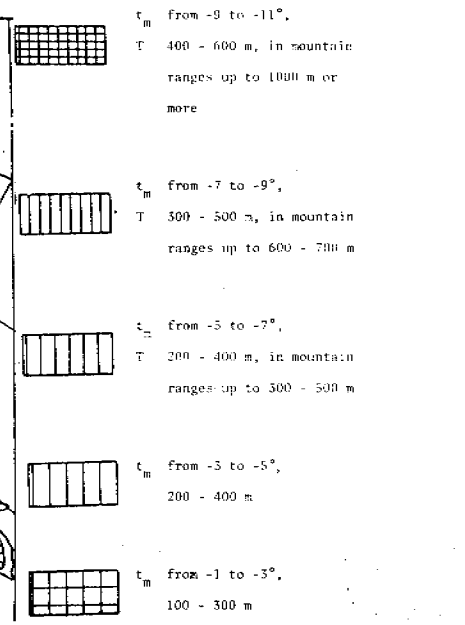
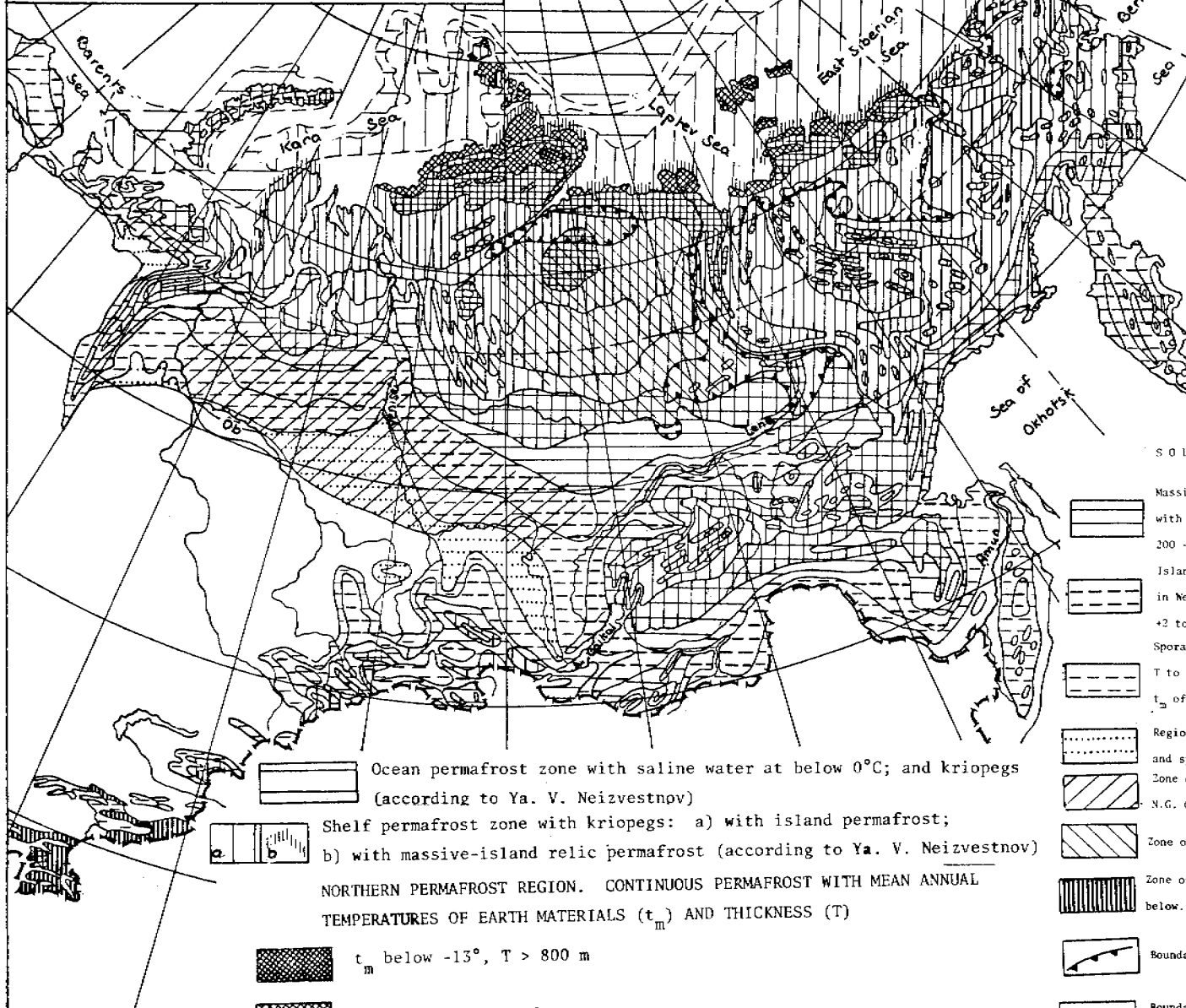

## SOUTHERN PERMAFROST REGION

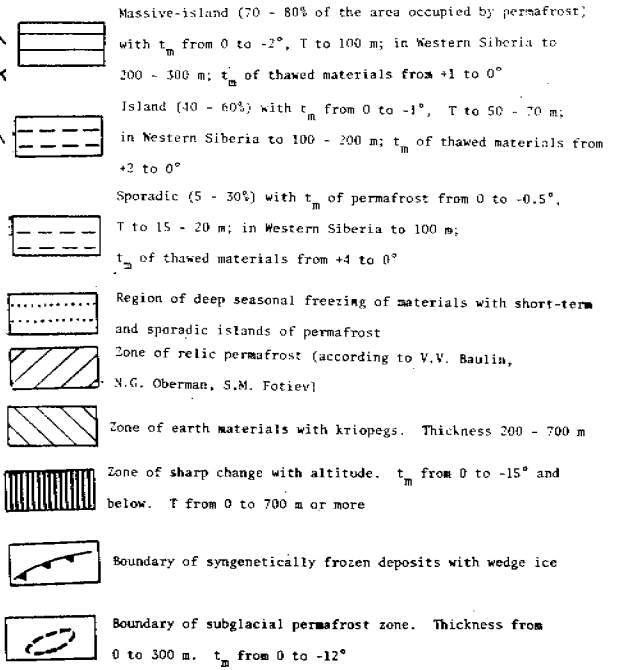

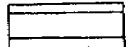
 Ocean permafrost zone with saline water at below  $0^\circ\text{C}$ ; and krioiegs (according to Ya. V. Neizvestnov)

 Shelf permafrost zone with krioiegs: a) with island permafrost; b) with massive-island relic permafrost (according to Ya. V. Neizvestnov)

## NORTHERN PERMAFROST REGION. CONTINUOUS PERMAFROST WITH MEAN ANNUAL TEMPERATURES OF EARTH MATERIALS ( $t_m$ ) AND THICKNESS ( $T$ )

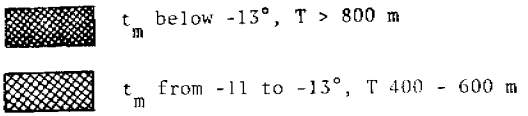

During compilation of the general map, traits which are similarly conditioned by: the permafrost region; geological, morphostructural and landscape environments, and which comprise the principle features of the geocryological map, scale 1 : 2,500,000, were generalized to a great extent. This made the generalized regional-zonal patterns of heat exchange between earth materials and the atmosphere more distinct. Finally, land was subdivided on the general map in accordance with latitudinal zonality based on: receipt of solar radiant energy; distribution of the land masses and oceans determining the degree of continentality of the heat exchange; and on surface relief and other surface conditions determining the level of heat exchange within the large orographic subdivisions.

A scheme for dividing the permafrost region has been drawn up on the basis of depth of occurrence with respect to the surface, where heat exchange between the atmosphere and the soil takes place; and on the basis of peculiarities of individual parts of the cross section, with respect to age and features of the permafrost region associated with the geological and palaeographic conditions of its development.

Figure 1 shows that the permafrost region can be divided into three parts: 1) the permafrost region developed within the continental mass - subaerial; 2) the region developed beneath glaciers - subglacial; and 3) the region developed under the seas and oceans - submarine. The subaerial region is in turn subdivided into Holocene and Holocene-Pleistocene occurring below the layer of seasonal thaw; the relic Pleistocene permafrost lying at some depth from the surface of the layer of seasonal thaw. The age of the permafrost generalized in the classification system is differentiated on the geocryological map of the U.S.S.R., scale 1 : 2,000,000. Further subdivision of the subaerial region is in accordance with the presence of ice (permafrost in earth materials) or chilling below 0°C for salt water or brine (kriopegs). Within the submarine region, a distinction is made between the shelf area with the relic, Pleistocene permafrost, kriopeg-containing layers chilled below 0°C and the deep ocean zone with Pleistocene kriopegs.

A more detailed account of the subaerial zone is included in this paper. This zone has been studied for more than 40 years in the U.S.S.R. by a large team of researchers.

Figure 1

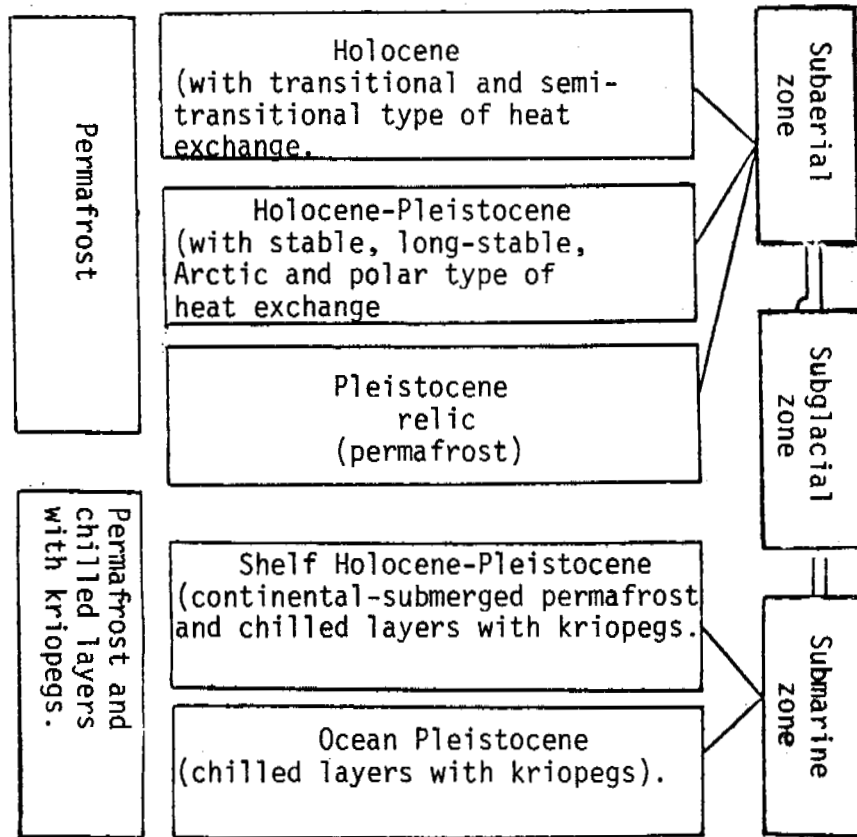

Subdivision of permafrost region for the geocryological map, scale 1 : 25,000,000

The subaerial type of continental permafrost region is the most common, as it is associated with present day conditions of heat exchange at the earth's surface and it included the northeast part of the European U.S.S.R., West and North Siberia, the Northeast and East of the Soviet Union, Prebaikal and Transbaikal, and the high mountain regions of the southern U.S.S.R. Owing to the fact that the type of heat exchange at the earth's surface is associated with such factors as composition, structure and characteristics of the earth materials, snow and vegetative cover, summer settlement and infiltration, swamp, and runoff conditions, etc., the subaerial zone is subdivided into two regions according to type of temperature regime and its degree of activity. The first region is a

transitional and semi-transitional type of heat exchange (southern); the second is the stable, long-stable, arctic and polar type of heat exchange (northern). These types of temperature regime are distinguished by V.A. Kudryavtsev (Dostovalov, Kudryavtsev, 1967) when classifying seasonal freezing and thawing on the basis of resistance to temperature transition through  $0^{\circ}\text{C}$ .

The most variegated and dynamic region is the southern geocryological region. This region has 4 zones, delineated according to the prevalent level of heat exchange and type of permafrost distribution. The distribution type is determined on the basis of area, that is, the area occupied by permafrost and the area of the whole zone. Divisions are made in a south to north direction, and in the case of mountain areas, on the basis of altitude: 1) zone of severe winter freezing and short-term permafrost, 2) zone of sporadic freezing (5 to 30% of the area occupied by permafrost), 3) zone of island permafrost (permafrost occupies from 40 to 60% of the zone) and 4) zone of massive-island permafrost (permafrost is from 70 to 90%).

The sporadic Holocene and present day permafrost developed in this zone is for the most part, frozen epigenetically and is characterized by a thermodynamically unstable temperature regime. The temperatures of the permafrost in this zone are mainly within the interval of 0 to  $-0.5^{\circ}$  and less frequently at  $-1^{\circ}\text{C}$ ; they are basically organogenic and organomineral sandy loam and clay loam soils, restricted to swampy depressions at watersheds and in valleys, and also to slopes with a northern exposure.

In the island permafrost, the prevailing mean annual temperatures of the permafrost are from 0 to  $-1^{\circ}$  and less frequently  $-2^{\circ}\text{C}$  (south Central Siberia) and are associated with organogenic and organomineral earth materials (north of the European part and West Siberia) and with mineral sandy foam - clay loam materials in valleys and at watersheds. Permafrost formation in this zone is determined by the present day complex environmental conditions, the combined influence of which, under favourable conditions of thermal insulation and infiltration, lead to the thawing of the earth materials, and, under unfavourable conditions, to freezing. The freezing of unconsolidated depositions of the syngenetic type can be accompanied by swamp

formation: the epigenetic freezing of bedrock in a fissured zone can lead to frost heave. When permafrost thaws, settlement, thermokarst and other processes occur. Towards the boundary of the zone of massive-island permafrost, the permafrost becomes more continuous and its temperature usually falls to  $-2^{\circ}\text{C}$ . In this zone, thawing is associated with the presence of a fissured area in the bedrock and with sandy massifs which provide favourable conditions for infiltration of summer settlement, both in the valleys and at the watersheds; in these areas it is also associated with snow cover.

The thickness of the permafrost underlying the layer of seasonal thaw in the southern region is found in accordance with existing environmental conditions and is mainly up to 15-20 m for sporadic permafrost, from 50 to 100 m for island permafrost, and from 100 to 150 m for massive-island permafrost.

The zones with the southern type of heat exchange, that is, zones along such major rivers as the Ob, Yenisei and the Lena, penetrate far into the region of continuous permafrost, and are azonal when surrounded by plakory heat exchange conditions. The development of azonal geocryological conditions in these valleys is conditions by their historical development in the Cenozoic and by present day heat exchange regimes conducive to thawing or to high temperature permafrost.

The peculiarities in the formation of geocryological conditions in the mountains of Central Asia, Kazakhstan and the Caucasus, all lying within the southern-type heat exchange area, are associated with altitudinal differentiation of the factors causing permafrost formation. The phenomenon of massive and island permafrost in the mountains is restricted to coarse granular talus and stone blocks on steep slopes (greater than  $35^{\circ}$ ) at altitudes from 1500 to 3000 m, with little snow and having a northern exposure (Gorbunov, 1974). Continuous permafrost with temperatures below  $-1$ ,  $-3^{\circ}$ , is, according to A.P. Gorbunov (1974), characteristic of mountain ranges with an altitude of from 3000-4500 m and higher, depending on their exposure, steepness of slope, and the general morphostructure of the mountain region.

The northern geologic province covers the area where, for the most part, continuous permafrost extends right to the surface. Along its southern periphery, there is a zone within which there are occurrences of massive-island permafrost; however, the taliks are mainly of the closed type. Mean annual temperatures of permafrost in this zone lie mainly within the range  $-1$  to  $-3^{\circ}\text{C}$ . Its formation is associated with the influence of the continentality of the climate and on the fairly favourable heat exchange conditions at the surface. Under the local conditions, this combined influence leads to the formation of permafrost which is predominantly from 100 to 300 m thick. In the parts of the fissured area and sandy massifs which intrude into the summer settlement, and also under large rivers and lakes, the continuous permafrost is interrupted by thawed ground, occupying from 5 to 15% of the zone. The zone of continuous permafrost with temperatures ranging from  $-3$  to  $-15^{\circ}\text{C}$  and below is divided on the map into subzones at intervals of  $2^{\circ}\text{C}$  on the basis of heat exchange. The principle of using temperature regime subdivisions as a means of establishing zones (at intervals of  $5^{\circ}\text{C}$ ) was formulated earlier by Kudryavtsev (1954). Analysis of existing factual material undertaken during the compilation of the geocryological map of the U.S.S.R., on a scale of 1 : 2,000,000, made it possible to differentiate geocryological zones with predominant mean annual temperature of the earth materials of from  $-3$  to  $-5^{\circ}$ , from  $-5$  to  $-7^{\circ}$ , from  $-7$  to  $-9^{\circ}$ , from  $-9$  to  $-11^{\circ}$ , from  $-11$  to  $-13^{\circ}$ , from  $-13$  to  $-15^{\circ}$  and those below  $-15^{\circ}\text{C}$ . This method of subdividing adequately characterizes the peculiarities of the heat exchange regimes (structural-geological, geomorphological and landscape-climatic) which exist under specific local conditions.

Characteristic of these zones is thick permafrost, which formed in the Pleistocene and is still forming at the present time, and the presence of taliks, found only under bodies of water, rivers and in places where groundwater is discharged. The lowest mean annual temperatures of from  $-13$  to  $-15^{\circ}\text{C}$  and lower are found in the earth materials high in the Byrranga mountains on the Taimyr; in areas of the Novosibirsk Islands not covered by glaciers; and at the top of high mountain ranges in North Transbaikal, particularly in the Pamirs and Tien Shan. Mean annual temperatures of from  $-9$  to  $-13^{\circ}\text{C}$  occur in the earth materials of the Putoran mountains, in the mountains and interior areas of Taimyr, on the ridges of the Verkhoyansk and

Cherskii ranges, of the Pamirs and the Tien Shan ranges, and also in the northern Primorsk lowlands composed of Pleistocene and Holocene permafrost with thick ice wedges.

The thickness and structure of the continuous permafrost has no direct connection with the present day climatic conditions; it depends upon the time they were formed and the degree of changeability of the thermodynamic conditions as they developed. All this, in turn, is essentially dependent on the palaeographic conditions, geological structure, composition and moisture content of the earth materials, geomorphological and hydrogeological factors and the heat flow from the earth's interior: the latter is essentially determined by the age of the geological textures increasing with decrease in age of the permafrost. Therefore, the tendency of continuous permafrost to be thicker towards the north and, in the mountains, with increase in altitude, is complicated by a number of other factors (presence of relic permafrost and chilling to below  $0^{\circ}\text{C}$  for earth materials containing kryopegs).

The thickness of the permafrost is dependent on the time of its formation, therefore, within the stretch of Holocene marine terraces, the thickness of the permafrost does not exceed 100-200 m in the European, Northeast U.S.S.R. or 200-300 m in northern Siberia. It lies next to the older, Pleistocene, surface permafrost of a different origin, where the thickness can be as great as 500-700 m.

In mountain regions, the thickness of the permafrost can increase considerably, owing to the influence of the vertical geocryological zonality of the temperature of the earth materials; the large surface area of the mountain blocks, which is conducive to cooling; the well-drained earth materials and their high thermal conductivity during the period of freezing. As a result, the permafrost found at high altitudes in the mountain ranges is 200 to 300 m thicker than that of the geocryotemperature zone delineated on the map. In the mountains of North Transbaikal the thickness of the permafrost reaches 1200 to 1300 m, despite the region's southerly position.

The vertical zonality of the permafrost in the southern half of Central Siberia is conditioned by the fact that earth materials, chilled



below 0°C and containing saline water and brine, are found above the permafrost. Consequently, the permafrost within the Palaeozoic cover the Central Siberian platform reaches 800 to 1500 m, increasing in thickness from the southern limit of the continuous permafrost zone towards the Anabar shield.

Where the zone of fresh and subsaline waters extends below the depth of perennial freezing, the layer of perennially frozen earth materials comprises the whole cross-section and virtually coincides with the zero geoisotherm as is the case in the Verkhoyansk-Chukotskaya fold mountain region; in the artesian basins of the larger part of the Western Siberian Basin and part of the Yakutsk Basin. The permafrost region in the ancient shields (Anabar, Aldan) has two layers: the upper layer, restricted to the zone of exogenic fissuring and comprised of permafrost, and a lower layer, restricted to non-fissured, chilled earth materials which are penetrated by water along the veins. The permafrost in the Anabar is, on the average, 700 to 900 m thick, fluctuating between 600 and 1500 m depending on relief features, composition of the earth materials and the interior tectonic zone (Yakov et al., 1976).

On the basis of the type of freezing, regions with predominantly syngenetic permafrost extending right to the surface are distinguished from the prevalent epigenetic permafrost.

The upper layer of the permafrost cross-section is comprised of syngenetically frozen layers with a thickness of from 1-2 to 50-100 m differing in origin and age. These layers usually contain wedge ice and have evenly distributed layered structures throughout the section. The ice content of the syngenetically frozen earth materials often reaches 70-95% of the total volume. These depositions are mainly restricted to the low aggradation plains, and, in mountains and on plateaux, to river valley and intermontane Meso-Cenozoic depressions. On plains formed from syngenetically frozen layers, the following features are widely developed: thermokarst lakes; thermoabrasion; thermal erosion; frost fracturing; ice wedges, etc. An extensive shelf formed near the shores of Siberia due to abrasion of these depositions by the Holocene sea.

Within the plateaux, fold mountain regions and denuded plains, there are mainly epigenetically frozen and chilled consolidated and semi-consolidated materials. Inherited cryogenic structures (fissures, fissure-vein, fissure-karst, etc.) and relatively low ice content decreasing with depth are characteristic of these rocks. Cryogenic slope processes and frost heave in rock materials are widely developed, and in the valleys and depressions of the fold mountain region, there are icings.

In the West Siberian Lowland, in the north of Central Siberia, Eastern Siberia and the Anadyr Lowland there are widely developed, epigenetically frozen, unconsolidated sandy clay loams of lacustrine, alluvial, glacial, meltwater or seawater origin; their structure and ice content varying within wide limits. The highest volumetric ice content (40-60%) is found in the layers nearest the surface (up to several tens of metres thick); young deposits have a higher ice content than the ancient, consolidated and lithified deposits; formation of thick, segregated and injected ice (up to 10 m or more) is associated with the freezing of the water bearing layers of unconsolidated materials. Thermokarst, frost heaving and frost fracturing are also characteristic of this terrain.

Relic Pleistocene layers of permafrost are developed in the European Northeast U.S.S.R. (Oberman, 1974), in Western Siberia (Zemtsov, 1958; Baulin, 1962; and others) and, in the south of Central Siberia (Fotiev et al., 1974) within the southern region of massive-island, island and sporadic permafrost. The relic layer of frozen earth materials up to 200-300 m thick lies at, from 80-100 to 200-250 m from the surface and is characterized by temperatures slightly below 0°C. In areas where Holocene permafrost extends from the surface, the permafrost is in two layers. In Western Siberia, the southern boundary of relic permafrost extends 2 to 3° further south than the present day permafrost. Where the present day and Pleistocene permafrost meet along the boundary of the north and south geocryological regions, the thickness of the permafrost increases sharply (Oberman, 1974; Fotiev et al., 1974). In the North-East European part of the U.S.S.R. and in Central Siberia, the present day permafrost boundary lies further south than that of the relic permafrost, and the two layer band of permafrost is not very wide.

A subglacial permafrost zone has developed under glaciers in the mountains and on the Arctic islands of the Polar Basin, the Novaya Zemlya archipelago, Franz Josef Land, Severnaya Zemlya, Schmidt Island, Ushakov Island and Bennet Island. The formation of the subglacial permafrost zone is associated with the thickness of the glaciers, with the type of temperature regime in the layer of temperature fluctuations and with heat flow from the earth's interior towards the base of the glaciers; this is related to the type of geological structure and its neotectonic development.

The arctic islands were, in a geocryological sense, characterized for the first time on the geocryological map of the U.S.S.R., scale 1 : 2,500,000. Both on this map and on the map presented in this paper, demarcation of geocryological zones is made on the basis of the degree of heat exchange on the ice sheets, from -1 to -3<sup>0</sup>C on the ice of Novaya Zemlya, from -3 to -11<sup>0</sup>C on the ice caps of Franz Josef Land, and from -5 to -15<sup>0</sup>C on the ice caps of Severnaya Zemlya. Calculations were performed for the above mentioned regime of mean annual temperatures existing at the base of the layer of annual temperature fluctuations of glaciers and ice sheets with predominant thicknesses of from 200-300 to 500-600 m. Using temperature gradients towards the base of 1<sup>0</sup>/100 m and 2<sup>0</sup>/100 m, calculations of temperatures at the base of glaciers indicated that beneath them was developed mainly permafrost with temperatures from 0<sup>0</sup>C (North island of Novaya Zemlya, Alexandra Land and George Land: the Franz Josef Land archipelago) to -11<sup>0</sup>C (Gukera Island: Franz Josef Land, etc.). The thickness of the earth materials below the glacial cover, both those which are perennially frozen and those which are chilled below 0<sup>0</sup>C and which contain saline water, depends on the above listed conditions and is presumably between 100 and 400 m.

The submarine permafrost zone encompassing the bottom of the northern seas, is divided into a shelf zone and a deep ocean zone. The earth materials of the shelf zone underwent permafrost transformation on dry land, mainly within the limits of the aggradation plains and were later submerged as a result of transgression. The upper layers of the depositions, which have a high ice content, were reworked by the sea; the mean annual temperature of the sea floor depositions rose to -1.9, -0.7<sup>0</sup>C; the ice of the

upper layers dissolved and mixed with the seawater. Consequently, a layer of earth materials containing saline water formed, below which lies relic permafrost degrading not only from above, but also below, due to the earth's internal heat. The degree of degradation depends on the time it became submerged. Because of this, the thickness of the permafrost zone decreases and the discontinuity increases away from the coast towards the water. In the shallow area of the shelf, there is seasonal thawing, and coastal marine syngenetically frozen depositions form. Near the estuaries of major rivers either there is an absence of permafrost or else it is 'island' in character.

The deep ocean permafrost zone is made up of seawater saturated earth materials with temperatures to  $-0.7^{\circ}\text{C}$ . Apparently, it occupies a large part of the Polar Basin and is characterized by a thickness of several tens of metres.

In conclusion, it should be noted that regionalization of the permafrost area on a general scale allows the generalization of the characteristics of geocryological conditions with a view to reflecting the common zonal and regional patterns of their formation. The regionalization map discussed can be used as a geographical basis for communicating the construction norms and regulations being compiled for development of the permafrost region.

#### REFERENCES

- BAULIN V.V. Osnovnye etapy istorii razvitiya mnogoletnemerzlykh porod na territorii Zapadno-Sibirskoi nizmennosti. (Basic stages in the history of development of the permafrost in the West Siberian Lowland). - Trudy In-ta merzlotovedeniya im. V.A. Obrucheva, Vol. 19., Moscow, Izd-vo AN SSSR, pp. 5-18, 1962.
- BARANOV I.Ya. Geokriologicheskaya karta SSSR. (Geocryological Map of the U.S.S.R.). Scale 1 : 10,000,000. Poyasnitel'naya Zapiska (Explanatory Notes). Moscow, 48 pages, 1960.
- GORBUNOV A.P. Poyas vechnoi merzloty Tyan'-Shanya. (The permafrost zone of Tien Shan'). Avtoreferat dokt. diss. (Abstract of Doctoral Diss.) Moscow, 33 pages, 1974
- DOSTOVALOV B.N. and KUDRYAVTSEV V.A. Obshchee merzlotovedenie. (General Permafrost Studies). Izd-vo MGU, pp. 235-278, 1967.

- ZEMTSOV A.A. O rasprostraneniі mnogoletnemerzlykh gornykh porod v Zapadnoi Sibiri. (Permafrost distribution in Western Siberia). "Nauch. dokl. Vyssh. shkoly. Geol-geogr. nauki", No. 3, pp. 43-49, 1958
- KALABIN A.I. Vechnaya merzlota i gidrogeologiya Severo-Vostoka SSSR. (Permafrost and hydrogeology of the Northeast U.S.S.R.). Trudy VNII-1 Vol. 18, Magadan, 471 pages, 1960.
- KUDRYAVTSEV V.A. Temperatura verkhnykh gorizontov vechnomerzloi tolshchi v predelakh SSSR. (Temperature of the upper permafrost horizons in the U.S.S.R.). Moscow, Izd-vo AN SSSR, 183 pages, 1954.
- MEL'NIKOV P.I. Skhematicheskaya geokriologicheskaya karta Yakutskoi ASSR. (Schematic geocryological map of the Yakut ASSR). Scale 1 : 5,000,000 - In the book: Gidrogeologiya SSSR. (Hydrogeology of the U.S.S.R.). Vol. XX, Yakutskaya ASSR., Moscow, Nedra, 1970.
- NEIZVESTNOV Ya.V., OBIDIN N.I., TOLSTIKHIN N.I. and TOLSTIKHIN O.N. Gidrogeologicheskoe raionirovanie i gidrogeologicheskie usloviya sovetskogo sektora Arktiki. (Hydrogeological regionalization and hydrogeological conditions in the Soviet Arctic). In the book: Geologiya i poleznye iskopaemye severa Sibirskoi platformy. (Geology and minerals of the north of the Siberian Platform). L., pp. 92-105, 1971.
- NEKRASOV I.A. Novye dannye ob osobennostyakh stroeniya i ploshchada razvitiya kriolitozony v predelakh territorii SSSR. (New data on the peculiarities of the structure and area of development of the permafrost zone in the U.S.S.R.). "Dokl. AN SSSR", Vol. 194, No. 3, pp. 643-646, 1970.
- OBERMAN N.G. Regional'nye osobennosti merzloi zony Timano-Ural'skoi oblasti. (Regional peculiarities of the permafrost zone of Imano-Ural'skaya Province). Izv. Vysshikh uchebn. zavedenii. Geologiya i razvedka. No. 11, pp. 98-103, 1974.
- PARKHOMENKO S.G. Skhematicheskaya karta raionov merzloty i glubokogo promerzaniya SSSR. (Schematic map of the regions of permafrost and deep freezing in the U.S.S.R.). Trudy TSNIi geodez. aerofotos' emki i kartogr., No. 16, pp. 18-24, 1937.
- POPOV A.I. Merzlotno-geologicheskoe raionirovanie oblasti vechnoi merzloty v SSSR. (Permafrost-geological regionalization of the permafrost zone in the U.S.S.R.). Inform. sbornik o rabotakh po mezhdunar. geofiz. godu geogr. f-ta. (Information on projects undertaken by the Faculty of Geography at Moscow University for International Geophysical Year). MGU. Moscow, No. 1, pp. 239-264, 1958.
- POPOV A.I. Chetvertichnyi period v Zapadnoi Sibiri. (The Quaternary period in Western Siberia). In the book: Lednikovyi period na territorii Europeiskoi chasti SSSR i Sibiri. (Ice Age in the European part of the U.S.S.R. and Siberia). Izd-vo MGU, pp. 88-102, 1959.

- POPOV A.I. Vechnaya merzlota. (Permafrost). In the book: Atlas Irkutskoi oblasti. (Atlas of Irkutsk Province). Moskva-Irkutsk, 36 pages, 1962.
- SUMGIN M.I. Vechnaya merzlota pochv v predelakh SSSR. (Permafrost soils in the U.S.S.R.). Vladivostok, 372 pages, 1927.
- SUMGIN M.I. Vechnaya merzlota pochv v predelakh SSSR. (Permafrost soils in the U.S.S.R.) Moscow, Izd-vo AN SSSR, 380 pages, 1937.
- TUMEL' V.F. Karta rasprostraneniya vechnoi merzloty v SSSR. (Map of permafrost distribution in the U.S.S.R.). Merzlotovedenie, Vol. 1, No. 1, pp. 5-11, 1946.
- FOTIEV S.M., DANILOVA N.S. and SHEVELEVA N.S. Geokriologicheskie usloviya Srednei Sibiri. (Geocryological conditions in Central Siberia). Moscow, Nauka, 147 pages, 1974.
- SHVETSOV P.F. O printsipakh raionirovaniya kriolitozony. (Principle regionalization of the permafrost zone). In the book: Materialy k osnovam ucheniya o merzlykh zonakh zemnoi kory. (Basic material for study of the permafrost zone of the earth's crust). Moscow, Izd-vo AN SSSR, No. 3, pp. 18-39, 1956.
- YAKUPOV V.S., ALIEV A.A. and DEMCHENKO O.V. et al., Moshchnost' merzloi tolshchi na Anabarskom kristallicheskom massive (po dannym VEZ). (Thickness of permafrost on the Anbar Crystalline Massif (according to vertical electronic sounding data)). In the book: Geofizicheskie metody issledovaniya merzlykh tolshch. (Geophysical methods in permafrost research). Yakutsk, pp. 22-28, 1976.



CRYOLITHOLOGICAL MAP OF THE U.S.S.R. (PRINCIPLES OF COMPILATION)

A.I. Popov, G.E. Rozenbaum and A.V. Vostokova

Department of Geography, Moscow State University, U.S.S.R.

In recent years, lithogenetic research into aspects of the steady cooling of the Earth has resulted in the development of a new branch of science - cryolithology. The object of research in this science is permafrost: the product of a particular type of lithogenesis, namely cryolithogenesis, which is inherent to cold regions.

Cryolithogenesis results from specific regional conditions. It is a combination of processes existing in the lithosphere, i.e., in the landscape features of arctic and subarctic regions, the northern part of the humid zone, and high altitude regions; for these all provide the conditions necessary for permafrost formation.

Study of the structural patterns of permafrost, of the distribution of ice within the permafrost, of the processes connected with the formation and thawing of ice are of great importance for the development and utilization of natural resources in the north and the northeast U.S.S.R., for the protection and rational use of the environment in these areas. This has prompted the compilation of a cryolithological map of the U.S.S.R. Available work on the theoretical principles of cryolithology, the formulation of a scientifically based classification system for permafrost, and the accumulation of extensive factual material concerning the permafrost in these regions of the U.S.S.R. make this task feasible. However, the scientific data only allow compilation at a scale of 1 : 4,000,000 and no larger. It should be noted that this is the very first time that such a map has been produced.



An exposition of the principles used in the compilation of a cryolithological map must be prefaced by the presentation of certain basic positions held in the field of cryolithology; for it is these positions which form the basis of the very principles themselves.

Cryolithogenesis as a specific process of lithogenesis acts in two capacities: as cryodiagenesis and as cryohypergenesis. Cryodiagenesis is the process of protracted, irreversible formation of ice, and the transformation of the mineral substratum itself (consolidation, dewatering, cementation, etc.), without any significant changes in dispersion either in recently deposited sediments or in materials lithified at an earlier date. In this case, the ice is an authigenous mineral, a stable, long-lasting component of the permafrost.

Cryohypergenesis is the process of frost weathering of various materials as a result of repeated freeze-thaw cycles (mainly seasonal); this process is the reversible, systematic (i.e., sporadic) formation of ice, leading to a significant change in dispersion, to a gradual refinement not only of massive materials, but also of unconsolidated materials with particles greater than the silt fraction, and to an aggregation of clayey particles. In this case, the ice is a temporary, active, authigenous mineral, often not confining itself to the eluvium which was already formed.

In its capacity as a process of cryodiagenesis, cryolithogenesis is active in the formation of permafrost; and as a process of cryohypergenesis, it extends beyond this sphere, into the realm of seasonal freezing of materials.

Two types of cryogenic materials result from cryodiagenesis: kryolity and kryolityty. Kryolity are materials containing only pure ice: monomineral materials; kryolityty are polymineral materials, where ice is only one of the mineral components.

Cryogenic eluvium which forms as a result of frost weathering is a product of cryohypergenesis. In winter, when the cryogenic eluvium of the active layer is frozen, it becomes transformed into kryolityty.

A cryolithological map must show, as fully as possible, the genetic diversity of permafrost, the characteristics of its structure, and its distribution. However, in this case, certain difficulties arise restricting the possibilities in this regard.

The mapping of this type of permafrost, both within the limits of perennial freezing and beyond, is complicated by the following factors: a) genetic interpretation of the loess silts which exist in both permafrost and the areas of seasonal freezing is open to dispute; b) insufficient theoretical work has been done on matters concerned with the processes of cryohypergenesis, leaving the questions of diagnosis and classification of cryogenic eluvium unresolved. Moreover, the mapping of cryogenic eluvium in the layer of seasonal thawing creates additional technical difficulties when depicted on a map showing the cryogenic structure of its underlying permafrost. At this stage, all these complications can only be overcome by excluding cryogenic eluvium from the map, therefore, the information presented on the map must be limited to depicting two observed genetic types of permafrost - kryolity and kryolitivity, which are the products of cryolithogenesis in only one of its capacities, i.e., of cryodiagenesis. Consequently, only permafrost was depicted on the map.

The small scale of the map does not permit the marking of permafrost islands, nor does it allow the basic distribution patterns to be depicted by a generalization. This makes it particularly difficult in the case of mountainous regions, where the exposure, the density of the broken relief, and other factors of geomorphology, physical geography and geology influence the distribution of permafrost. As a result, the island character of the permafrost near the southern boundary was not depicted on the map.

Owing to the complexity and number of stages in the permafrost structure, mapping had to be restricted to the uppermost horizon 20 m in thickness. The entire permafrost structure for individual regions is shown in the cryolithological columns.

The main principles behind the map's legend are the identification of the genetic types of frozen earth materials and their combinations,

together with the identification of the types of cryolithogenesis characteristic of these materials.

As was previously noted, the map reflects two genetic types of frozen earth materials: kryolity and kryolitivity. It is usual for kryolity to occur naturally with kryolitivity, which form the accommodating materials. The only exception is surface ice, such as alpine glaciers, icings, etc. Kryolitivity often form independently and, over a great distance, will contain no bodies of ice; that is, no kryolity.

On account of this, the "types of frozen materials" shown in the legend are divided into the following groups: kryolitivity; kryolity with accommodating kryolitivity; and kryolity. To the second ground belong the earth materials with ice content; this includes kryolity manifest as polygonal ice wedges which, in combination with their accommodating kryolity, can form either patterned ground, or the ice core of a hydrolaccolith. The third group (kryolity) includes surface ice; alpine glaciers and icings.

Kryolity occur naturally as various genetic types of ground ice, which are combined into two groups: konzhelity and khionolity. Only the first group appear in the legend since khionolity are rare. Kryolity (konzhelity) appear in the legend as the following types of ground ice: polygonal wedge ice; sheet ice; or ice cores of hydrolaccoliths. Polygonal ice wedges are subdivided into relic and active.

Two genetic types of ice are active in the formation of kryolity: segregated ice and ice cement. Combinations of these two genetic types are particularly widespread; this is reflected in the legend.

The various structures are determined by the distribution of ice in the materials. A simple classification system is used in the legend. The following divisions are made: streaky cryostructures formed by segregated ice (layered; reticulate; ice lenses), and other modifications and cryostructures formed by ice cement; massive, basal and crustal structures in unconsolidated materials, and fissured structures in solid and semisolid materials.

Structure type, characteristics of distribution through the section, and participation of various genetic types of ground ice are, to a large degree, determined by the type of freezing, i.e., by the type of cryolithogenesis. The type of cryolithogenesis can vary depending on the conditions under which it takes place: the physical geography, temperatures, lithology and facies, etc.

All possible occurrences of cryolithogenesis can be reduced to two basic types - epigenetic and syngenetic. Epigenetic cryolithogenesis takes place in materials which have undergone some degree of lithification. Syngenetic cryolithogenesis is fundamental to lithogenesis, that is, freezing is a basic factor in lithification; it accompanies sedimentation.

Both types of cryolithogenesis, each in its own way, exert an influence on the formation of frozen materials, on the internal distribution and amount of ice they contain, and on structure type.

Characteristic of epigenetic permafrost are: a decrease in ice content throughout the section, by the replacement (in the northern regions) of the thin layers and reticulate structures, by thicker layers and a more distinctly reticulate structure and finally by massive structure as the depth increases and the temperature gradient decreases.

Characteristic of syngenetic permafrost is an even distribution of ice throughout the section, infrequent occurrence of polygonal wedge ice, a specific combination of reticulate and distinctly reticulate structure, ice lenses, and a high ice content.

There is a definite connection between genesis and age of materials, zonal, geographical conditions and the type of cryolithogenesis. In so far as permafrost formation first started at the beginning of the Pleistocene, all of the more ancient rocks froze epigenetically. During the Holocene maximum, in the south of the permafrost zone, the materials thawed almost completely, with the exception of the lowest relic layer, which had become established in the southern regions. So that, regardless of age, (with the exception of present day deposits - i.e., those after the Holocene

maximum), genesis or lithology, all present-day permafrost in this zone froze epigenetically. Its loss of water is, to a certain degree, connected with its refreezing, as is its relatively low ice saturation, even in the near surface horizons. Moreover, here, there is a direct relationship between physical appearance of the structure and the small temperature gradients at the time the structure was formed; these were close to present day temperatures. In this case, distinctly reticulate structures with thick layers; ice lenses; and massive structures are the most widely developed structures in the thinly dispersed deposits. Here, the great depth of seasonal thaw accounts for the absence of polygonal wedge ice.

In the northern part of the permafrost zone, there is a clear connection between type of cryolithogenesis and facies-genetic affiliation of the deposits. Frozen marine deposits, marine deposits containing ice, glacial deposits, etc., belong to the epigenetic type of cryolithogenesis: alluvial lake deposits, etc., to the syngenetic type. Consequently, epigenetic permafrost prevails on the vast plains of Western Siberia, where there are marine deposits containing ice; and on the Yana-Kolyma Lowland and on the plains of Central Yakutia, there is syngenetic permafrost resulting from the wide occurrence of alluvial lake deposits. By taking into account the close affiliation of type of freezing, structure type and the genesis, age, and lithology of the accommodating materials to ensure correct spatial distribution and reliability of boundaries, lithological genetic maps prepared the way for the compilation of the cryolithological map. Maps of Quarternary deposits and geological engineering maps were used as the basic sources for the compilation of the lithological maps.

A combination of two types of cryolithogenesis (polygenetic permafrost) is very common in permafrost profiles. This is illustrated by the following examples: the lake and swamp deposits of the alas plains\*, alluvial deposits with epigenetically frozen river beds and syngenetically frozen floodplain alluvium; and talus-solifluction deposits frozen syngenetically and covering epigenetically frozen, solid and semi-solid

---

\* Alas - depression with gentle slopes and flat bottom, typical of some permafrost regions (Transl.).

materials, etc. Such combinations figure in the legend. Moreover, in the mountain regions, different types of cryolithogenesis alternate within short distances. The impossibility of reflecting these alternations to scale led to the necessity of introducing combinations of the two types of cryolithogenesis into the legend, to reflect their occurrence not only in the profile, but also spatially.

Apart from type of conditions and type of freezing, structure type is directly dependent on lithology and humidity. For example, massive, crustal, and basal structures formed by ice cement are typical of thickly dispersed deposits (sands and coarse granular); a fissured structure, also formed by ice cement, is characteristic of solid and semi-solid materials. High humidity leads to the formation of thickly dispersed deposits: low humidity to the formation of a basal structure.

In finely dispersed deposits (clayey and sandy), ice lenses, partially reticulate structures and, in the case of high compaction, massive structure occur when there is low humidity and a considerable admixture of sandy or coarse-grained material. It is the frequency and depth of the ice layers, apart from the lithology and humidity, which determine the rate of the freezing.

As a rule, great variations in lithology and humidity throughout the profiles and over the area of dispersion, create certain difficulties when the structures are being mapped. These circumstances are presented in the legend by combining various structures. The lithological variation throughout the profile within the 20 m horizon is shown as a fraction, in which the structures of the uppermost horizon are given above the line, the structures of the underlying horizon - below the line. For example:

massive  
reticulate with thick layers

signifies massive structure in the uppermost horizon, formed by ice cement in either sandy and coarse granular deposits or in peat, this alternates downwards through the profile with thick layers distinctly reticulate in structure, which are formed by the segregated ice in the underlying clayey or sandy clayey deposits.

An important factor in the compilation of the map is the working out of the principles used in the formulation and selection of methods of depiction; these are always closely related to the content and function of the map: as a wall map, or for demonstration purposes. For the depiction of types of frozen materials and types of cryolithogenesis, the basic method was selected, i.e., a coloured background. Thus the different types of cryolithogenesis are clearly distinguished by sharp differences in colour; and kryolity are distinguished from the kryolity and their accommodating materials (in the cooler colours) by various colour ranges. Kryolity, manifest as sheet ice, ice cores of hydrolaccoliths, or icings are represented on the map by symbols. The map's expressiveness, its clarity of representation and its readability at a distance are ensured by using colour to full advantage. The variations in structure of the materials determined by cryogenic structure are reflected by the shade of colour assigned to the given groups. The lithology of the unconsolidated materials accommodating the ice is indicated by different types of coloured hatching. The genesis and age of the materials is shown in the key.

The cryolithological columns contain information on the stratigraphy, genesis and lithology of the materials, and indicates the thickness of the individual stratigraphic horizons. The presence of the remains of flora and fauna, concretions, and pseudomorpha in the ice veins is marked by the special, conventional symbols. The columns supply the detailed characteristics of the permafrost structure, indicate the thickness, the mean annual temperature of the materials (the latter indicates the level of heat exchange), and the distribution of volumetric ice content throughout the horizon.

These are the most important principles of compilation and the main features of the cryolithological map of the U.S.S.R. It is the first attempt to depict permafrost as a single entity manifest in different forms. Unlike other permafrost maps, which usually depict a large number of different permafrost features but do not show a clear connection between them all, this map only depicts those characteristics which primarily reflect the casual relationships between the structure and lithology, the facies genetic affiliation and the age of the accommodating rocks. Moreover, the map

illustrates the spatial distribution of the types of cryolithogenesis and reflects the zonality of processes and the morphological results of cryolithogenesis, which are all largely subordinate to the temperature zonality of the permafrost.



